

# MAZUVO

GARTEN- UND OBJEKTMÖBEL • SEIT 1959



OBJEKT INNENMÖBEL 2023

MEUBLES INTÉRIEURS POUR COLLECTIVITÉS 2023



# MAZUVO

Januar 2023 – V 1.0

REFERENZBILD:  
ELDORA AG GEBÄUDE A1 M.O.V.E  
ZÜRICH

# MAZUVO

GARTEN- UND OBJEKTMÖBEL • SEIT 1959

Aktuelle Preislisten und Kataloge finden Sie unter: [www.mazuvo.ch/2023](http://www.mazuvo.ch/2023)  
Vous trouverez les listes de prix et les catalogues actuels sur: [www.mazuvo.ch/2023](http://www.mazuvo.ch/2023)

# MAZUVO SIEHT DIE MENSCHEN ALS GÄSTE. ÜBERALL. KUNDEN, MITARBEITER, BESUCHER, BEWOHNER, PATIENTEN ODER KLIENTEN.

Wir sind Gäste in einer Umgebung. Manchmal für eine kurze Wartezeit, manchmal um sich nach langer Zeit wieder zu treffen, manchmal um gemeinsam zu entspannen, manchmal für einen längeren Aufenthalt. Es ist die gesamte Erinnerung an einen solchen Besuch oder Aufenthalt, die bleibt. Das Interieur, die Einrichtung oder die Möbel in der Umgebung spielen eine wesentliche Rolle für das Wohlbefinden und die Erfahrung eines jeden Gastes. Davon sind wir überzeugt. Wir kennen uns mit Massarbeit aus, verfügen über eine umfangreiche Kollektion von Qualitätsmöbeln für den Innen- und Aussenbereich. Was uns motiviert ist denkbar einfach: Wir lieben, was wir tun!

Als Objektmöbel Spezialist haben wir eine jahrelange Erfahrung im Entwurf und der Umsetzung von Klein- und Grossprojekten. Nebst hoher Fachkompetenz, Kreativität und einem internationalen Netzwerk an Lieferanten, bringen wir spürbare Begeisterung und Leidenschaft mit. Mit uns erhalten Sie einen Ansprechpartner, auf den Sie sich jederzeit verlassen können! Wir beraten Sie mit Freude und bieten Ihnen mit unserem Knowhow ganze Unterstützung – sei es in unserem Showroom in Volketswil oder bei Ihnen vor Ort.

## SHOWROOM

Der Showroom ist die Quelle für Inspiration und Innovation. Für Sie wie auch für uns! Deshalb haben wir bei der Gestaltung unserer Showrooms grossen Wert darauf gelegt, dass Sie sich als Kunde möglichst wohl fühlen bei uns. Selbstverständlich verfügen wir über die notwendigen Material- und Stoffmuster, zudem bieten wir Ihnen die Möglichkeit, für Bemusterungen Mustermöbel zur Verfügung zu stellen.

## MARKEN & LIEFERANTEN

Unsere Marken- und Lieferantenbasis ist eine unserer wichtigsten Ressourcen. Bei der Auswahl berücksichtigen wir neben den Produkten auch deren Leistungen in Bezug auf Sicherheit, Gesundheit, Umwelt, soziale Standards und faire Geschäftspraktiken. Wir erwarten von unseren Partnern, dass ihr Verhalten stets unserem Anspruch an Qualität, Zuverlässigkeit, Professionalität und nachhaltigem Handeln gerecht werden.

## ANFERTIGUNGEN AUF MASS

Besondere Situationen verlangen nach besonderen Lösungen. Unsere Aufgabe ist es Ihren individuellen Anforderungen gerecht zu werden und Ihre Wünsche perfekt umzusetzen. Egal ob es sich bei Ihrem Thema um Tische, Bänke oder Sonnenschirme handelt, wir werden alles daransetzen, das Beste für Sie zu schaffen. Denn wir sind nicht nur Einrichter, sondern auch Erfinder.



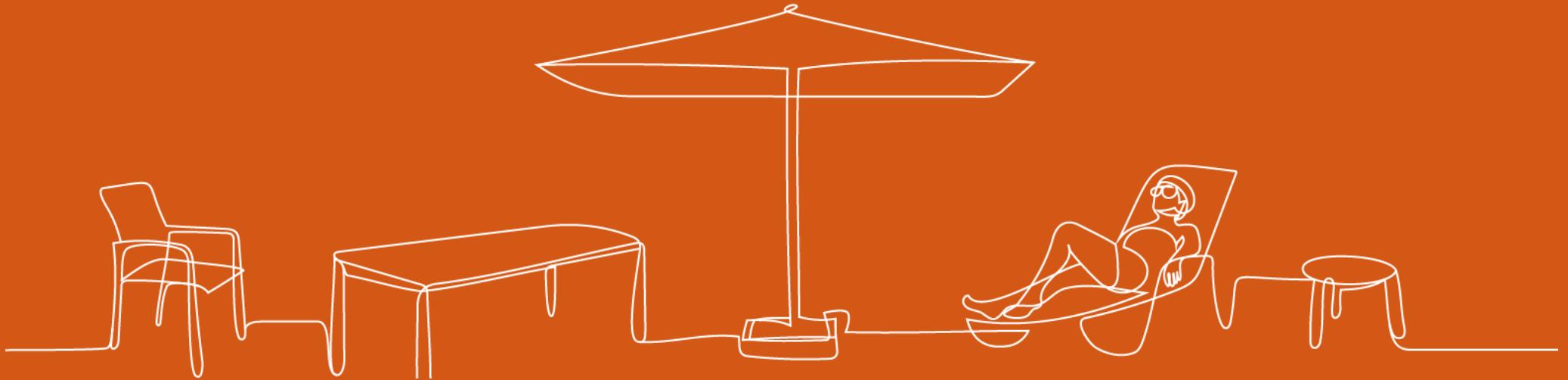

#### REPARATUREN, SERVICELEISTUNGEN, EINLAGERUNG

Wir reparieren nicht nur, weil wir es können, sondern wir tun dies aus Überzeugung. Auch bei den besten Produkten kann es vorkommen, dass die Zeit am Zahn nagt oder ein Teil kaputt geht. Mit unserem Servicecenter und unserer Sonnenschirm Klinik (siehe Seite 999) sind wir in der Lage Ihnen ein rundum Sorglospaket anbieten zu können. Ersatzteile wie z.B. Fusskappen für Stühle finden Sie in unserem Ersatzteil Shop unter:

[www.mazuvo.ch/ersatzteile-outlet-shop/](http://www.mazuvo.ch/ersatzteile-outlet-shop/)

#### GARANTIE

Unser wichtigstes Ziel ist es, Produkte in so hoher Qualität anzubieten, dass Sie so lange wie möglich Freude daran haben. Die Garantiefrist beträgt generell 2 Jahre ab dem Zeitpunkt der Lieferung bzw. Abholung durch den Kunden oder Kundin. Auf alle Produkte die unter unserer Eigenmarke MAZUVO laufen, erhalten Sie 3 Jahre Garantie.

#### MATERIAL HINWEISE UND PFLEGEANLEITUNGEN

Wer die Langlebigkeit seiner Möbel sicherstellen möchte, sollte das jeweilige Material reinigen und pflegen. Doch welche Materialien brauchen welche Pflege? Wie häufig muss man die Gegenstände reinigen? Und welches Pflegeprodukt ist das Richtige? Unter [www.mazuvo.ch/pflegenanleitungen](http://www.mazuvo.ch/pflegenanleitungen) finden Sie auf all diese Fragen antworten mit cleveren Tipps und Tricks zur effektiven Materialpflege.

#### NACHHALTIGKEIT

Langlebigkeit ist für uns ein wichtiger Bestandteil und bedeutsamer Beitrag zur Nachhaltigkeit. Dieses Verantwortungsbewusstsein ist für MAZUVO ein fester Bestandteil der Vision und Unternehmenskultur.

#### PREISE 2023

Es kann vorkommen, dass unsere Lieferanten die Verkaufspreise während dem laufenden Jahr anpassen. Damit Sie immer auf dem aktuellen Stand sind, finden Sie auf [www.mazuvo.ch/2023](http://www.mazuvo.ch/2023) einen Überblick der gültigen Versionen von Preislisten und Katalogen. Die Preise sind inkl. MWST. Preis- und Modelländerungen vorbehalten.

#### ALLGEMEINE GESCHÄFTSBEDINGUNGEN

Unsere Allgemeinen Geschäftsbedingungen finden Sie unter [www.mazuvo.ch/agb/](http://www.mazuvo.ch/agb/).

#### LAGERWARE

In unserem Katalog ist hinterlegt, welche Artikel wir immer an Lager Schweiz führen und welche wir ab Lager Lieferant aus Europa beziehen:



# MAZUVO CONSIDÈRE LES GENS COMME DES INVITÉS. PARTOUT OÙ ILS SE TROUVENT. QU'ILS SOIENT COLLABORATEURS, VISITEURS, RÉSIDENTS, PATIENTS OU CLIENTS.

Nous sommes au quotidien les invités d'un environnement. Parfois pour une courte attente, parfois pour se retrouver après une longue période, parfois pour se détendre ensemble et parfois pour un séjour plus long. À la fin, c'est le souvenir global d'une telle visite ou d'un tel séjour qui nous reste en mémoire. L'intérieur, l'aménagement ou le mobilier de l'environnement jouent également un rôle essentiel dans le bien-être et l'expérience de chaque hôte. Nous en sommes convaincus. Nous avons une grande expérience du travail sur mesure et disposons d'une vaste collection de meubles de qualité pour l'intérieur et l'extérieur. Ce qui nous motive est tout simple : nous aimons ce que nous faisons !

En tant que spécialistes du mobilier pour les collectivités, nous avons des années d'expérience dans la conception et la réalisation de petits et grands projets. En plus d'une grande compétence professionnelle, de notre créativité et d'un réseau international de fournisseurs, nous apportons un enthousiasme et une passion palpables. Avec nous, vous avez un interlocuteur sur lequel vous pouvez compter à tout moment ! Nous vous conseillerons avec plaisir et vous offrirons tout notre soutien grâce à notre savoir-faire, que ce soit dans notre showroom de Volketswil ou à domicile.

## SHOWROOM

Notre showroom est la source d'inspiration et d'innovation. Pour vous comme pour nous ! C'est pourquoi nous avons accordé une grande importance à l'aménagement de nos showrooms, afin que vous, en tant que client, vous sentiez le plus à l'aise possible chez

nous. Naturellement, nous avons sur place tous les échantillons de matériaux et de tissus nécessaires. Nous vous offrons en outre la possibilité de mettre à votre disposition des échantillons de meubles pour des échantillonnages.

## MARQUES & FOURNISSEURS

Notre catalogue de marques et de fournisseurs est l'une de nos ressources les plus importantes. Lors de la sélection, nous tenons compte non seulement des produits, mais aussi de leurs performances en matière de sécurité, de santé, d'environnement, de normes sociales et de pratiques commerciales équitables. Nous attendons de nos partenaires que leur comportement soit toujours à la hauteur de nos exigences en matière de qualité, de fiabilité, de professionnalisme et d'action durable.

## FABRICATIONS SUR MESURE

Les situations particulières exigent des solutions particulières. Notre mission consiste à répondre à vos exigences individuelles et à réaliser vos souhaits à la perfection. Que votre besoin concerne des tables, des bancs ou des parasols, nous mettrons tout en œuvre pour créer ce qu'il y a de mieux pour vous. Car nous ne sommes pas uniquement des aménageurs, mais aussi des inventeurs.



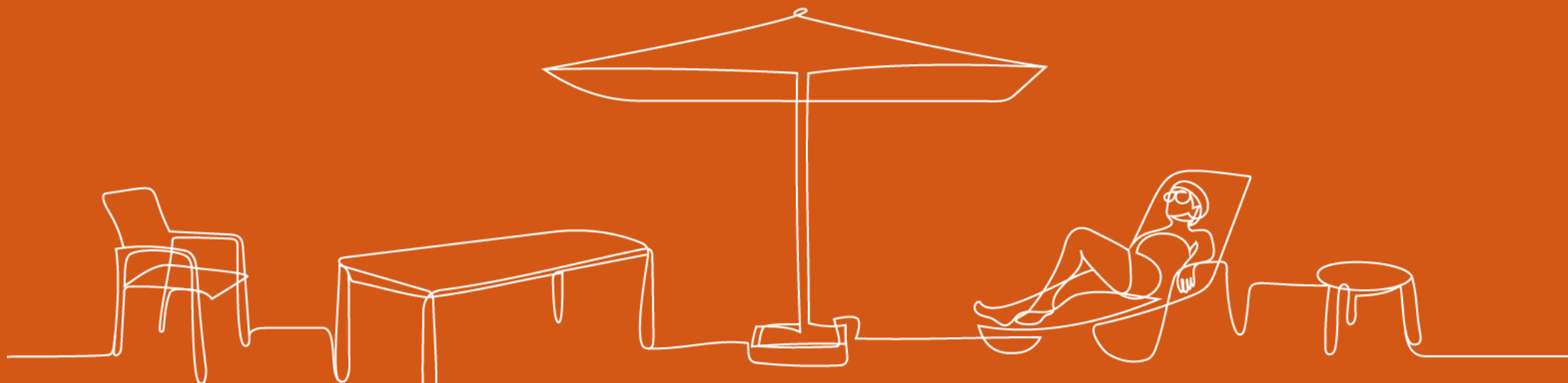

#### RÉPARATIONS & PRESTATIONS DE SERVICE

Nous ne réparons pas seulement parce que nous le pouvons, mais nous le faisons par conviction. Même avec les meilleurs produits, il peut arriver que le temps fasse son œuvre ou qu'une pièce se casse. Grâce à notre centre de service, nous sommes en mesure de remettre en état les produits défectueux. Vous trouverez des pièces de rechange sur [www.mazuvo.ch/ersatzteile-outlet-shop/](http://www.mazuvo.ch/ersatzteile-outlet-shop/)

#### GARANTIE

Notre objectif principal est de proposer des produits d'une qualité telle que vous puissiez en profiter le plus longtemps possible. La période de garantie est généralement de 2 ans à partir de la date de livraison ou de retrait par le client ou la cliente. Tous les produits vendus sous notre propre marque MAZUVO sont garantis 3 ans.

#### CONSEILS SUR LES MATÉRIAUX ET INSTRUCTIONS D'ENTRETIEN

Pour garantir la longévité de vos meubles, il convient de nettoyer et d'entretenir les différents matériaux. Mais quels matériaux nécessitent quel entretien? À quelle fréquence faut-il nettoyer les objets? Et quel produit d'entretien est le plus approprié?

Sur [www.mazuvo.ch/pflegenleitungen](http://www.mazuvo.ch/pflegenleitungen), vous trouverez les réponses à toutes ces questions, avec des conseils et astuces pour un entretien efficace de tous les matériaux.

#### DURABILITÉ

La longévité est pour nous un élément important et une contribution significative à la durabilité. Pour MAZUVO, ce sens des responsabilités fait partie intégrante de notre vision et de notre culture d'entreprise.

#### RIX 2023

Il peut arriver que nos fournisseurs adaptent leurs prix de vente en cours d'année. Pour que vous soyez toujours au courant des versions en vigueur, vous trouverez sur [www.mazuvo.ch/2023](http://www.mazuvo.ch/2023) un aperçu de nos listes de prix et des catalogues. Les prix s'entendent TVA incluse. Sous réserve de modifications de prix et de modèles.

#### CONDITIONS GÉNÉRALES DE VENTE

Vous trouverez nos conditions générales de vente sur [www.mazuvo.ch/agb/](http://www.mazuvo.ch/agb/).

#### MARCHANDISES EN STOCK

Dans notre catalogue, nous indiquons quels articles sont en stock en Suisse et quels articles sont en stock chez nos fournisseurs:



# MARKEN. MARQUES.

Aufgrund unserer 60-jährigen Erfahrung haben wir ein Lieferantennetzwerk aufgebaut, das auf den weltweit führenden Herstellern von Garten- und Objektmöbeln basiert. Diese zeichnen sich durch Qualität, Nachhaltigkeit, Top-Design, Innovation und Materialvielfalt aus. Nebst den speziell für unsere Schweizer Kundschaft designten Möbeln unserer Eigenmarke MAZUVO vertreibt MAZUVO AG weitere internationale und nationale Marken.

## GENERALVERTRETUNGEN SCHWEIZ:

Cassecroute, Todus, conmoto, Cinas, Liro, Lume

## KOOPERATIONSPARTNER SCHWEIZ:

solpuri

## EXKLUSIVPARTNER:

Glatz

Pendant nos 60 ans d'activité, nous avons établi un réseau de partenaires et fournisseurs. Tous des spécialistes dans le mobilier de jardin et de parasol. Celles-ci se caractérisent par la qualité, la durabilité, la conception de pointe, l'innovation et la diversité des matériaux. Outre les meubles de notre propre marque MAZUVO, spécialement conçus pour notre clientèle suisse, MAZUVO AG vend d'autres marques internationales et nationales.

## REPRÉSENTANTE GÉNÉRALE POUR LA SUISSE:

Cassecroute, Todus, conmoto, Cinas, Liro, Lume

## PARTENAIRE DE COOPÉRATION SUISSE:

solpuri

## PARTENARIAT EXCLUSIF:

Glatz





# INHALT. CONTENU.

## CLASSIC & MODERN Holzstühle

CLASSIC & MODERN chaises en bois

- 10 Bergamo
- 12 Ideal & PIZ
- 14 Model 14 & 18
- 16 Model 33 & 150
- 18 Ironica, Model 24 & 56
- 20 Nym & Nemea
- 22 Norma
- 24 Banana & Era
- 26 Punton & Petit
- 28 Stockholm & Prag
- 30 811 / 822
- 34 Valencia
- 36 Leaf
- 38 Moritz & Merano
- 42 Lisa
- 46 Blume, Vic & Jazz
- 50 Kicca & Split

## Konferenz und Saalbestuhlung

Chaises de conférence

- 54 Kuadra
- 58 Airolo, Trend, Inga
- 59 Alice

## Lounge

- 60 Chips
- 62 Split
- 64 Merano & Kyk

## Barhocker

Tabouret de bar

- 66 Merano & Leaf
- 68 Banana, Ironica, Ideal  
Stockholm & Punton
- 69 Valencia & Split
- 70 811 & 822, Brera
- 72 Kuadra, Kicca, Arki

## Bänke und Sofa

Banc et sofa

- 74 Nomad & Kyk
- 76 Social Plus
- 78 Buddy & Buddyhub

## Modulare Sitzgruppe

Banquette modular

- 84 Modus
- 86 Diner

## Konferenz- und Saaltische

Table de conférence

- 88 Kompakt
- 89 Timmy & Eco
- 92 Stapelkarren

## Tische

Table

- 93 Bloom
- 95 Delta & Malmö
- 96 Ironica & Lasu  
Stockholm & Ink44
- 97 P.O.V

## Tischuntergestelle

Piètement de table

- 100 Inox
- 103 Tonda & Step
- 105 Dream & Quadra
- 112 Easy & Fluxo
- 116 Bold & Zenith
- 120 Laja & Ypsilon
- 125 Elliot
- 128 Nostalgie & Nosti
- 130 Bistrot
- 131 Nosti & Gerade
- 133 Travers & Pilz
- 136 Hexagon
- 137 Easy Mix and Fix

## Tischplatten

Plateau de tables

- 138 Scab
- 140 Pedrali Chrome
- 142 Pedrali Fenix
- 144 Pedrali Laminat
- 146 Pedrali Compact
- 148 MAZUVO Holzplatten Eiche
- 150 MAZUVO Holzplatten Buche
- 152 MAZUVO Holzplatten Nussb.
- 154 MAZUVO Belegte Platten

## HEY SIGN

- 156 Filzmuster
- 158 Paravent Welle
- 160 Paravent Welle gebogen
- 162 Leuchte & Hängemodul Welle
- 163 Wandmodul & Tischmodul Welle



Lagerartikel Schweiz  
Articles en stock en suisse



Lieferfrist ab Europa-Lager:  
ca. 6-8 Wochen  
Delais de livraison depuis stock  
europeen: env. 6-8 semaines

# KATALOGE & PREISLISTEN 2023. CATALOGUES & LISTES DE PRIX 2023.

In unseren MAZUVO Katalogen können wir leider nur einen kleinen Teil unserer grossen Produktpalette zeigen. Selbstverständlich haben Sie die Möglichkeit, auf die ganzen Sortimente unserer Partner Lieferanten zuzugreifen. Mit nachstehendem Link gelangen Sie auf unsere Markenübersicht mit allen aktuellen Katalogen und Preislisten.

► [www.mazuvo.ch/objektkunden/marken/](http://www.mazuvo.ch/objektkunden/marken/)

Dans nos catalogues MAZUVO, nous ne pouvons malheureusement présenter qu'une petite partie de notre vaste gamme de produits. Vous avez bien entendu la possibilité d'accéder à l'ensemble des gammes de nos fournisseurs partenaires. Le lien ci-dessous vous permet d'accéder à notre aperçu des marques avec tous les catalogues et listes de prix actuels.

► [www.mazuvo.ch/objektkunden/marken/](http://www.mazuvo.ch/objektkunden/marken/)

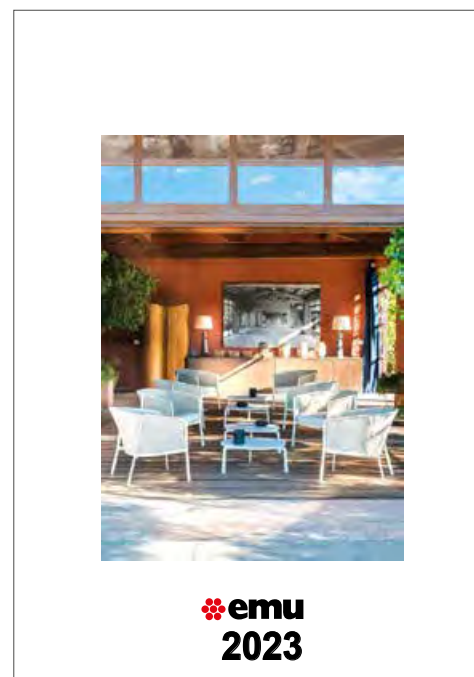



Sonnenschirme  
**Saison 2023**



**Glatz** 

**karasek**  
OUTDOOR LIVING



OBJEKT LINE 2023

**manufakt**

*Traditionen bewahren - Visionen entwickeln*

**2023**

**KATALOG**

**2023**  
In & Out  
**PEDRALI**

S-CAB



outdoor 2023

**solpuri**  
Germany  
Collection  
2023



Todus  
2023



 **TON**  
2023

  
**cat**



# REFERENZEN



ESTÉE LAUDER  
GALGENEN  
mit Trispace AG, Zürich



MICROSOFT-CAFÉ  
WEF DAVOS  
mit Kreativagentur standing ovation, Zürich



BAUARENA  
VOLKETSWIL  
Konzeption und Raumplanung:  
HAUSER UND PARTNER DÜBENDORF



OPENBIM FORUM  
LUZERN



# REFERENZEN



THE BRIDGE, MGallery Hotel  
WROCLAW, PL

Realisiert durch:  
SCAB DESIGN



ULMER OPTIK  
DIELSDORF



ZAPPA'S RESTAURANT  
HAVIŘOV, CZ

Realisiert durch:  
TON Möbel



SCHLOSS RUED



# REFERENZEN



## FUSSBALLVEREIN BORUSSIA MÖNCHENGLADBACH

Realisiert durch:  
CONMOTO



## COTIDIANO MÜNCHEN

Realisiert durch:  
TON Möbel

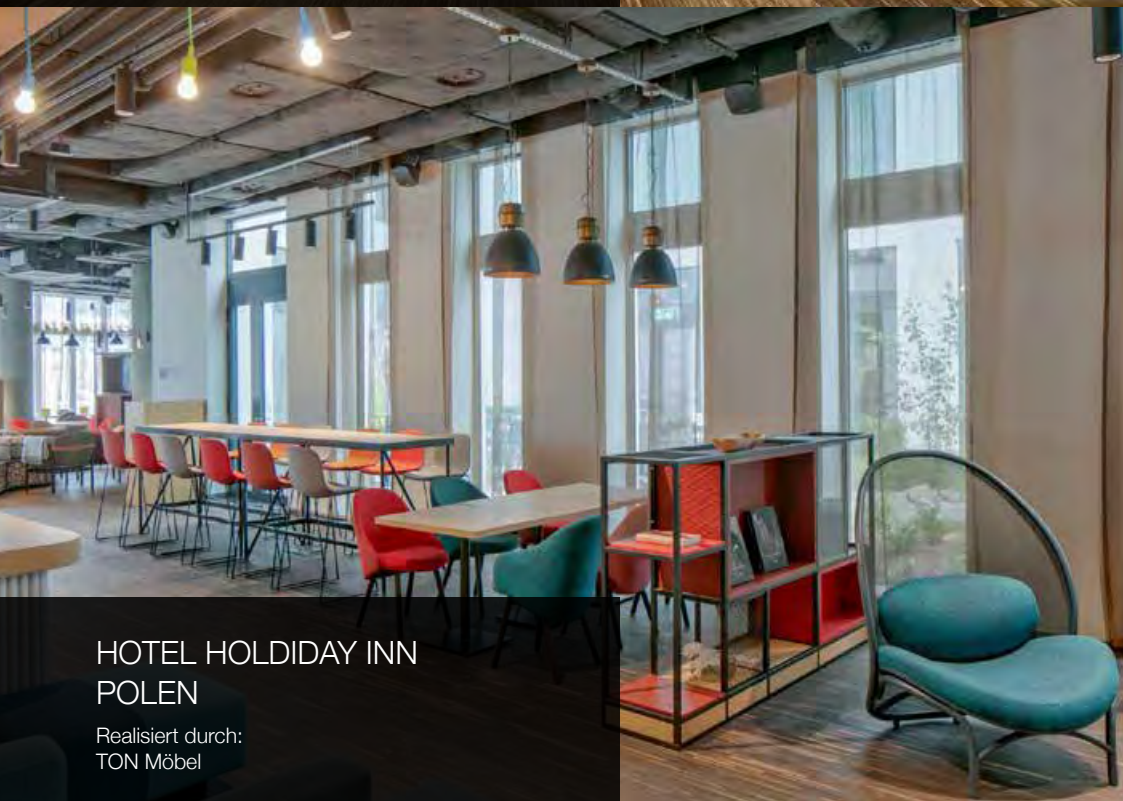

## HOTEL HOLDIDAY INN POLEN

Realisiert durch:  
TON Möbel



## THE POTTING SHED LANGLEY UNITED KINGDOM

Realisiert durch:  
TON Möbel





CHAIR TON

BIG WAP  
GO FROM 219 CZK





Abbildung / image	Artikel - Bezeichnung / description d'article	Preis Prix CHF												
	<p><b>BERGAMO</b> Stuhl ohne Armlehne Gestell Buche naturlackiert oder gebeizt nach Kollektion, stapelbar Sperrholzsitz gemäss Kollektion, Gewicht: 6.0kg Polsterung gemäss Kollektion</p> <p><b>BERGAMO</b> chaise sans accoudoirs Structure en hêtre naturel ou teinté selon collection, empilable Contreplaqué selon collection, poids: 6.0kg Rembourré selon collection</p> <table border="0"> <tr> <td>Gesamtbreite (cm)</td> <td>Gesamttiefe (cm)</td> <td>Gesamthöhe (cm)</td> </tr> <tr> <td><b>48</b></td> <td><b>51</b></td> <td><b>83,7</b></td> </tr> <tr> <td>Sitzhöhe (cm)</td> <td>Sitzbreite (cm)</td> <td>Sitztiefe (cm)</td> </tr> <tr> <td><b>46</b></td> <td><b>42</b></td> <td><b>44</b></td> </tr> </table>	Gesamtbreite (cm)	Gesamttiefe (cm)	Gesamthöhe (cm)	<b>48</b>	<b>51</b>	<b>83,7</b>	Sitzhöhe (cm)	Sitzbreite (cm)	Sitztiefe (cm)	<b>46</b>	<b>42</b>	<b>44</b>	<p>ab 439.- ab 449.-</p> <p>à partir de 439.- 449.-</p>
Gesamtbreite (cm)	Gesamttiefe (cm)	Gesamthöhe (cm)												
<b>48</b>	<b>51</b>	<b>83,7</b>												
Sitzhöhe (cm)	Sitzbreite (cm)	Sitztiefe (cm)												
<b>46</b>	<b>42</b>	<b>44</b>												
	<p><b>BERGAMO</b> Sessel mit Armlehne Gestell Buche naturlackiert oder gebeizt nach Kollektion, stapelbar Sperrholzsitz gemäss Kollektion, Gewicht: 7.5kg Polsterung gemäss Kollektion</p> <p><b>BERGAMO</b> fauteil avec accoudoirs Structure en hêtre naturel ou teinté selon collection, empilable Contreplaqué selon collection, poids: 7.5kg Rembourré selon collection</p> <table border="0"> <tr> <td>Gesamtbreite (cm)</td> <td>Gesamttiefe (cm)</td> <td>Gesamthöhe (cm)</td> </tr> <tr> <td><b>57</b></td> <td><b>51,5</b></td> <td><b>82</b></td> </tr> <tr> <td>Armlehne Höhe (cm)</td> <td>Sitzhöhe (cm)</td> <td>Sitzbreite (cm)</td> </tr> <tr> <td><b>66</b></td> <td><b>47</b></td> <td><b>41,6</b></td> </tr> </table>	Gesamtbreite (cm)	Gesamttiefe (cm)	Gesamthöhe (cm)	<b>57</b>	<b>51,5</b>	<b>82</b>	Armlehne Höhe (cm)	Sitzhöhe (cm)	Sitzbreite (cm)	<b>66</b>	<b>47</b>	<b>41,6</b>	<p>ab 569.- ab 579.-</p> <p>à partir de 569.- 579.-</p>
Gesamtbreite (cm)	Gesamttiefe (cm)	Gesamthöhe (cm)												
<b>57</b>	<b>51,5</b>	<b>82</b>												
Armlehne Höhe (cm)	Sitzhöhe (cm)	Sitzbreite (cm)												
<b>66</b>	<b>47</b>	<b>41,6</b>												











Abbildung / image	Artikel - Bezeichnung / description d'article	Preis Prix CHF
 <p>Sitzhöhe (cm) 46    Sitzbreite (cm) 40    Sitztiefe (cm) 40</p> <p>Gesamtbreite (cm) 45    Gesamttiefe (cm) 48,5    Gesamthöhe (cm) 84</p>	<p><b>IDEAL</b> Stuhl ohne Armlehne Gestell Buche naturlackiert oder gebeizt nach Kollektion Sperrholzsitz nach Kollektion, Gewicht: 4.6kg Polsterung gemäss Kollektion</p> <p><b>IDEAL</b> chaise sans accoudoirs Structure en hêtre naturel ou teinté selon collection Contreplaqué, poids: 4.6kg Rembourré selon collection</p>	<p>ab 289.- ab 299.-</p> <p>à partir de 289.- 299.-</p>
 <p>Gesamtbreite (cm) 45    Gesamttiefe (cm) 48,5    Gesamthöhe (cm) 84</p> <p>Sitzhöhe (cm) 46    Sitzbreite (cm) 40    Sitztiefe (cm) 40</p>	<p><b>IDEAL mit Beinverbinder (ehemals Modell PIZ)</b> Stuhl ohne Armlehne Gestell Buche naturlackiert oder gebeizt nach Kollektion Sperrholzsitz nach Kollektion, Gewicht: 4.7kg Polsterung gemäss Kollektion</p> <p><b>IDEAL avec connecteurs de jambes (anciennement modèle PIZ)</b> Chaise sans accoudoirs Structure en hêtre naturel ou teinté selon collection Contreplaqué, poids: 4.7kg Rembourré selon collection</p>	<p>ab 289.- ab 299.-</p> <p>à partir de 289.- 299.-</p>





Abbildung / image	Artikel - Bezeichnung / description d'article	Preis Prix CHF												
	<p><b>MODEL 14</b> Stuhl ohne Armlehne Gestell Buchenholz massiv. Holzsitzschale aus Sperrholz mit Prägung, Gewicht 2,8 kg</p> <p><b>MODEL 14</b> chaise sans accoudoirs Structure en hêtre massif. Siège en bois en contreplaqué avec gaufrage, poids 2,8 kg</p> <table border="0"> <tr> <td>Gesamtbreite (cm)</td> <td>Gesamttiefe (cm)</td> <td>Gesamthöhe (cm)</td> </tr> <tr> <td><b>41</b></td> <td><b>51,5</b></td> <td><b>84</b></td> </tr> <tr> <td>Sitzhöhe (cm)</td> <td>Sitzbreite (cm)</td> <td>Sitztiefe (cm)</td> </tr> <tr> <td><b>46</b></td> <td><b>Ø 40,5</b></td> <td><b>Ø 40,5</b></td> </tr> </table>	Gesamtbreite (cm)	Gesamttiefe (cm)	Gesamthöhe (cm)	<b>41</b>	<b>51,5</b>	<b>84</b>	Sitzhöhe (cm)	Sitzbreite (cm)	Sitztiefe (cm)	<b>46</b>	<b>Ø 40,5</b>	<b>Ø 40,5</b>	<p>ab à partir de 439.-</p>
Gesamtbreite (cm)	Gesamttiefe (cm)	Gesamthöhe (cm)												
<b>41</b>	<b>51,5</b>	<b>84</b>												
Sitzhöhe (cm)	Sitzbreite (cm)	Sitztiefe (cm)												
<b>46</b>	<b>Ø 40,5</b>	<b>Ø 40,5</b>												
	<p><b>MODEL 18</b> Stuhl ohne Armlehne Gestell Buchenholz massiv. Holzsitzschale aus Sperrholz mit Prägung, Gewicht 2,9 kg</p> <p><b>MODEL 18</b> chaise sans accoudoirs Structure en hêtre massif. Siège en bois en contreplaqué avec gaufrage, poids 2,9 kg</p> <table border="0"> <tr> <td>Gesamtbreite (cm)</td> <td>Gesamttiefe (cm)</td> <td>Gesamthöhe (cm)</td> </tr> <tr> <td><b>41</b></td> <td><b>51,5</b></td> <td><b>84</b></td> </tr> <tr> <td>Sitzhöhe (cm)</td> <td>Sitzbreite (cm)</td> <td>Sitztiefe (cm)</td> </tr> <tr> <td><b>46</b></td> <td><b>Ø 40,5</b></td> <td><b>Ø 40,5</b></td> </tr> </table>	Gesamtbreite (cm)	Gesamttiefe (cm)	Gesamthöhe (cm)	<b>41</b>	<b>51,5</b>	<b>84</b>	Sitzhöhe (cm)	Sitzbreite (cm)	Sitztiefe (cm)	<b>46</b>	<b>Ø 40,5</b>	<b>Ø 40,5</b>	<p>ab à partir de 449.-</p>
Gesamtbreite (cm)	Gesamttiefe (cm)	Gesamthöhe (cm)												
<b>41</b>	<b>51,5</b>	<b>84</b>												
Sitzhöhe (cm)	Sitzbreite (cm)	Sitztiefe (cm)												
<b>46</b>	<b>Ø 40,5</b>	<b>Ø 40,5</b>												



Modell 04



Modell 763





Déjavu



Modell 20







Abbildung / image	Artikel - Bezeichnung / description d'article	Preis Prix CHF																		
	<p><b>MODEL 33</b> Sessel mit Armlehne Gestell Buchenholz massiv. Diverse Ausführungen und Polsterungen möglich</p> <p><b>MODEL 33</b> chaise avec accoudoirs Structure en hêtre massif. Différents finitions et divers tissus de rembourrage possible</p> <table border="1" data-bbox="734 427 1375 660"> <tr> <td>Gesamtbreite (cm)</td> <td>Gesamttiefe (cm)</td> <td>Gesamthöhe (cm)</td> </tr> <tr> <td><b>54.5</b></td> <td><b>57</b></td> <td><b>76</b></td> </tr> <tr> <td>Ellenbogenhöhe (cm)</td> <td>Sitzhöhe (cm)</td> <td>Sitzbreite (cm)</td> </tr> <tr> <td><b>68</b></td> <td><b>46</b></td> <td><b>Ø 48</b></td> </tr> <tr> <td>Sitztiefe (cm)</td> <td>Produktgewicht (kg)</td> <td>Stoffverbrauch (m)</td> </tr> <tr> <td><b>Ø 48</b></td> <td><b>4.9</b></td> <td><b>0,844</b></td> </tr> </table>	Gesamtbreite (cm)	Gesamttiefe (cm)	Gesamthöhe (cm)	<b>54.5</b>	<b>57</b>	<b>76</b>	Ellenbogenhöhe (cm)	Sitzhöhe (cm)	Sitzbreite (cm)	<b>68</b>	<b>46</b>	<b>Ø 48</b>	Sitztiefe (cm)	Produktgewicht (kg)	Stoffverbrauch (m)	<b>Ø 48</b>	<b>4.9</b>	<b>0,844</b>	<p>ab à partir de 569.-</p>
Gesamtbreite (cm)	Gesamttiefe (cm)	Gesamthöhe (cm)																		
<b>54.5</b>	<b>57</b>	<b>76</b>																		
Ellenbogenhöhe (cm)	Sitzhöhe (cm)	Sitzbreite (cm)																		
<b>68</b>	<b>46</b>	<b>Ø 48</b>																		
Sitztiefe (cm)	Produktgewicht (kg)	Stoffverbrauch (m)																		
<b>Ø 48</b>	<b>4.9</b>	<b>0,844</b>																		
	<p><b>MODEL 150</b> Stuhl ohne Armlehne Gestell Buchenholz massiv. Holzsitzschale aus Sperrholz, Gewicht: 3.7kg</p> <p><b>MODEL 150</b> chaise sans accoudoirs Structure en hêtre massif. Siège en bois en contreplaqué avec gaufrage, poids: 3.7kg</p> <table border="1" data-bbox="734 954 1323 1171"> <tr> <td>Gesamtbreite (cm)</td> <td>Gesamttiefe (cm)</td> <td>Gesamthöhe (cm)</td> </tr> <tr> <td><b>45</b></td> <td><b>51</b></td> <td><b>86,5</b></td> </tr> <tr> <td>Sitzhöhe (cm)</td> <td>Sitzbreite (cm)</td> <td>Sitztiefe (cm)</td> </tr> <tr> <td><b>46</b></td> <td><b>39,5</b></td> <td><b>40,5</b></td> </tr> <tr> <td>Produktgewicht (kg)</td> <td>Volumen (m3)</td> <td>Kartonmaße (cm)</td> </tr> <tr> <td><b>3,6</b></td> <td><b>0,183</b></td> <td><b>62 x 48 x 107</b></td> </tr> </table>	Gesamtbreite (cm)	Gesamttiefe (cm)	Gesamthöhe (cm)	<b>45</b>	<b>51</b>	<b>86,5</b>	Sitzhöhe (cm)	Sitzbreite (cm)	Sitztiefe (cm)	<b>46</b>	<b>39,5</b>	<b>40,5</b>	Produktgewicht (kg)	Volumen (m3)	Kartonmaße (cm)	<b>3,6</b>	<b>0,183</b>	<b>62 x 48 x 107</b>	<p>ab à partir de 469.-</p>
Gesamtbreite (cm)	Gesamttiefe (cm)	Gesamthöhe (cm)																		
<b>45</b>	<b>51</b>	<b>86,5</b>																		
Sitzhöhe (cm)	Sitzbreite (cm)	Sitztiefe (cm)																		
<b>46</b>	<b>39,5</b>	<b>40,5</b>																		
Produktgewicht (kg)	Volumen (m3)	Kartonmaße (cm)																		
<b>3,6</b>	<b>0,183</b>	<b>62 x 48 x 107</b>																		



 TON





















Abbildung / image	Artikel - Bezeichnung / description d'article	Preis Prix CHF																								
	<p><b>IRONICA</b> Stuhl ohne Armlehne Buche oder Eiche, ohne Sitzpolster / mit Sitzpolster</p> <p><b>IRONICA</b> chaise sans accoudoirs Hêtre ou chêne, sans rembourrage d'assise / avec rembourrage d'assise</p> <table border="0"> <tr> <td>Gesamtbreite (cm)</td> <td>Gesamttiefe (cm)</td> <td>Gesamthöhe (cm)</td> </tr> <tr> <td><b>44</b></td> <td><b>47,5</b></td> <td><b>84,5</b></td> </tr> <tr> <td>Sitzhöhe (cm)</td> <td>Sitzbreite (cm)</td> <td>Sitztiefe (cm)</td> </tr> <tr> <td><b>45</b></td> <td><b>41</b></td> <td><b>40</b></td> </tr> </table>	Gesamtbreite (cm)	Gesamttiefe (cm)	Gesamthöhe (cm)	<b>44</b>	<b>47,5</b>	<b>84,5</b>	Sitzhöhe (cm)	Sitzbreite (cm)	Sitztiefe (cm)	<b>45</b>	<b>41</b>	<b>40</b>	<p>ab 239.- / 309.-</p> <p>à partir de 239.- / 309.-</p>												
Gesamtbreite (cm)	Gesamttiefe (cm)	Gesamthöhe (cm)																								
<b>44</b>	<b>47,5</b>	<b>84,5</b>																								
Sitzhöhe (cm)	Sitzbreite (cm)	Sitztiefe (cm)																								
<b>45</b>	<b>41</b>	<b>40</b>																								
 <p style="text-align: center;">Model 24                      Model 56</p>	<p><b>MODEL 24</b> Stuhl mit Armlehne <b>MODEL 24</b> chaise avec accoudoirs Buche / Hêtre - Gewicht/poids: 5.3kg ohne Sitzpolster / mit Sitzpolster - sans rembourrage d'assise / avec rembourrage d'assise</p> <table border="0"> <tr> <td>Gesamtbreite (cm)</td> <td>Gesamttiefe (cm)</td> <td>Gesamthöhe (cm)</td> </tr> <tr> <td><b>57</b></td> <td><b>55</b></td> <td><b>78</b></td> </tr> <tr> <td>Armlehne Höhe (cm)</td> <td>Sitzhöhe (cm)</td> <td>Sitzbreite (cm)</td> </tr> <tr> <td><b>69,5</b></td> <td><b>46</b></td> <td><b>42,5</b></td> </tr> </table> <p><b>MODEL 56</b> Stuhl ohne Armlehne <b>MODEL 56</b> chaise sans accoudoirs Buche / Hêtre - Gewicht/poids: 4.0kg ohne Sitzpolster / mit Sitzpolster - sans rembourrage d'assise / avec rembourrage d'assise</p> <table border="0"> <tr> <td>Gesamtbreite (cm)</td> <td>Gesamttiefe (cm)</td> <td>Gesamthöhe (cm)</td> </tr> <tr> <td><b>44,5</b></td> <td><b>48</b></td> <td><b>80</b></td> </tr> <tr> <td>Sitzhöhe (cm)</td> <td>Sitzbreite (cm)</td> <td>Sitztiefe (cm)</td> </tr> <tr> <td><b>46</b></td> <td><b>39,5</b></td> <td><b>40,5</b></td> </tr> </table>	Gesamtbreite (cm)	Gesamttiefe (cm)	Gesamthöhe (cm)	<b>57</b>	<b>55</b>	<b>78</b>	Armlehne Höhe (cm)	Sitzhöhe (cm)	Sitzbreite (cm)	<b>69,5</b>	<b>46</b>	<b>42,5</b>	Gesamtbreite (cm)	Gesamttiefe (cm)	Gesamthöhe (cm)	<b>44,5</b>	<b>48</b>	<b>80</b>	Sitzhöhe (cm)	Sitzbreite (cm)	Sitztiefe (cm)	<b>46</b>	<b>39,5</b>	<b>40,5</b>	<p>ab à partir de 539.- / 559.-</p> <p>ab à partir de 399.- / 429.-</p>
Gesamtbreite (cm)	Gesamttiefe (cm)	Gesamthöhe (cm)																								
<b>57</b>	<b>55</b>	<b>78</b>																								
Armlehne Höhe (cm)	Sitzhöhe (cm)	Sitzbreite (cm)																								
<b>69,5</b>	<b>46</b>	<b>42,5</b>																								
Gesamtbreite (cm)	Gesamttiefe (cm)	Gesamthöhe (cm)																								
<b>44,5</b>	<b>48</b>	<b>80</b>																								
Sitzhöhe (cm)	Sitzbreite (cm)	Sitztiefe (cm)																								
<b>46</b>	<b>39,5</b>	<b>40,5</b>																								



**PEDRALI**®



Abbildung / image	Artikel - Bezeichnung / description d'article	Preis Prix CHF
	<p><b>NYM 2830</b> Stuhl ohne Armlehne, chaise sans accoudoirs Eschenholz mit Aluminiumverstärkung Bois de frêne avec renforcement en aluminium</p> <p><b>NYM 2835</b> Sessel mit Armlehne, fauteuil avec accoudoirs Eschenholz mit Aluminiumverstärkung Bois de frêne avec renforcement en aluminium</p> <div style="display: flex; justify-content: space-around; align-items: center;"> <div style="display: flex; gap: 10px;"> <div style="text-align: center;"> FR</div> <div style="text-align: center;"> N1</div> <div style="text-align: center;"> GC</div> <div style="text-align: center;"> BI</div> <div style="text-align: center;"> AN</div> </div> <div style="text-align: right;">    </div> </div> <p>Mindestbestellmenge: 2 Stk. / quantité minimale : 2 pcs.</p>	<p>ab à partir de 549.-</p> <p>ab à partir de 599.-</p>
	<p><b>NEMEA 2820</b> Stuhl ohne Armlehne, chaise sans accoudoirs Eschenholz mit Aluminiumverstärkung Bois de frêne avec renforcement en aluminium</p> <p><b>NEMEA 2825</b> Sessel mit Armlehne, fauteuil avec accoudoirs Eschenholz mit Aluminiumverstärkung Bois de frêne avec renforcement en aluminium</p> <p><b>Farben / couleurs:</b></p> <div style="display: flex; justify-content: space-around; align-items: center;"> <div style="text-align: center;"> FR</div> <div style="text-align: center;"> N1</div> <div style="text-align: center;"> GC</div> <div style="text-align: center;"> BI</div> <div style="text-align: center;"> AN</div> </div> <div style="text-align: right;">     </div> <p>Mindestbestellmenge: 2 Stk. / quantité minimale: 2 pcs.</p>	<p>ab à partir de 399.-</p> <p>ab à partir de 419.-</p>





 TON

SINCE 2016

**BISTRONE**

~ RESTAURANT & COFFEE ~



Abbildung / image	Artikel - Bezeichnung / description d'article	Preis Prix CHF
 <p>Masse: Höhe: 88cm, Breite: 55cm, Tiefe: 54cm Dimension: hauteur: 88cm, largeur: 55cm, profondeur: 54cm</p>	<p><b>NORMA (Alternative by TON)</b> Stuhl ohne Armlehne Diverse Holz Ausführungen und Polsterungen möglich</p> <p><b>NORMA (Alternative by TON)</b> chaise sans accoudoirs Différents finitions du bois et divers tissus de rembourrage possible</p> <p><b>Version:</b> ungepolstert, nicht stapelbar / non rembourré, non empilable <b>Version:</b> ungepolstert, stapelbar / non rembourré, empilable</p> <p>Mindestbestellmenge: 8 Stk. Quantité minimum: 8 pcs.</p> <p>Gewicht: 4.6kg Poids: 4.6kg</p>  <p><b>Zubehör:</b> Reihenverbindung / accessoire: raccordement de siège</p>	<p>ab à partir de</p> <p>349.- 369.-</p>



311 917



313 917



314 917









Abbildung / image	Artikel - Bezeichnung / description d'article	Preis Prix CHF												
 <p data-bbox="239 716 792 807">Gewicht/Poids: 3.7 kg Mindestbestellmenge und Verpackungseinheit: 2 Stk. Quantité minimum de commande et unité à: 2 pcs.</p>	<p data-bbox="896 268 1413 405"><b>BANANA</b> Stuhl ohne Armlehne Erhältlich in Buche, gebeizt nach Kollektion ohne Sitzpolster mit Sitzpolster, Stoffbezug gemäss Kollektion</p> <p data-bbox="896 488 1480 625"><b>BANANA</b> chaise sans accoudoirs Disponible en hêtre, teinté selon collection sans rembourrage d'assise avec rembourrage d'assise, tissu selon la collection</p> <table data-bbox="896 647 1615 785"> <tr> <td>Gesamtbreite (cm)</td> <td>Gesamttiefe (cm)</td> <td>Gesamthöhe (cm)</td> </tr> <tr> <td><b>46</b></td> <td><b>48,5</b></td> <td><b>82</b></td> </tr> <tr> <td>Sitzhöhe (cm)</td> <td>Sitzbreite (cm)</td> <td>Sitztiefe (cm)</td> </tr> <tr> <td><b>46</b></td> <td><b>39,5</b></td> <td><b>40,5</b></td> </tr> </table>	Gesamtbreite (cm)	Gesamttiefe (cm)	Gesamthöhe (cm)	<b>46</b>	<b>48,5</b>	<b>82</b>	Sitzhöhe (cm)	Sitzbreite (cm)	Sitztiefe (cm)	<b>46</b>	<b>39,5</b>	<b>40,5</b>	<p data-bbox="1991 341 2092 405">ab 349.- ab 379.-</p> <p data-bbox="1944 564 2136 628">à partir de 349.- à partir de 379.-</p>
Gesamtbreite (cm)	Gesamttiefe (cm)	Gesamthöhe (cm)												
<b>46</b>	<b>48,5</b>	<b>82</b>												
Sitzhöhe (cm)	Sitzbreite (cm)	Sitztiefe (cm)												
<b>46</b>	<b>39,5</b>	<b>40,5</b>												
 <p data-bbox="239 1299 792 1390">Gewicht/Poids: 4.0 kg Mindestbestellmenge und Verpackungseinheit: 2 Stk. Quantité minimum de commande et unité à: 2 pcs.</p>	<p data-bbox="896 884 1509 1021"><b>ERA</b> Stuhl ohne Armlehne Erhältlich in Eiche und Buche, gebeizt nach Kollektion ohne Sitzpolster mit Sitzpolster, Stoffbezug gemäss Kollektion</p> <p data-bbox="896 1069 1518 1206"><b>ERA</b> chaise sans accoudoirs Disponible en chêne et en hêtre, teinté selon collection sans rembourrage d'assise avec rembourrage d'assise, tissu selon la collection</p> <table data-bbox="896 1228 1585 1366"> <tr> <td>Gesamtbreite (cm)</td> <td>Gesamttiefe (cm)</td> <td>Gesamthöhe (cm)</td> </tr> <tr> <td><b>43</b></td> <td><b>50</b></td> <td><b>88</b></td> </tr> <tr> <td>Sitzhöhe (cm)</td> <td>Sitzbreite (cm)</td> <td>Sitztiefe (cm)</td> </tr> <tr> <td><b>46</b></td> <td><b>40</b></td> <td><b>40</b></td> </tr> </table>	Gesamtbreite (cm)	Gesamttiefe (cm)	Gesamthöhe (cm)	<b>43</b>	<b>50</b>	<b>88</b>	Sitzhöhe (cm)	Sitzbreite (cm)	Sitztiefe (cm)	<b>46</b>	<b>40</b>	<b>40</b>	<p data-bbox="1973 967 2074 1031">ab 569.- ab 759.-</p> <p data-bbox="1935 1142 2128 1206">à partir de 569.- à partir de 759.-</p>
Gesamtbreite (cm)	Gesamttiefe (cm)	Gesamthöhe (cm)												
<b>43</b>	<b>50</b>	<b>88</b>												
Sitzhöhe (cm)	Sitzbreite (cm)	Sitztiefe (cm)												
<b>46</b>	<b>40</b>	<b>40</b>												



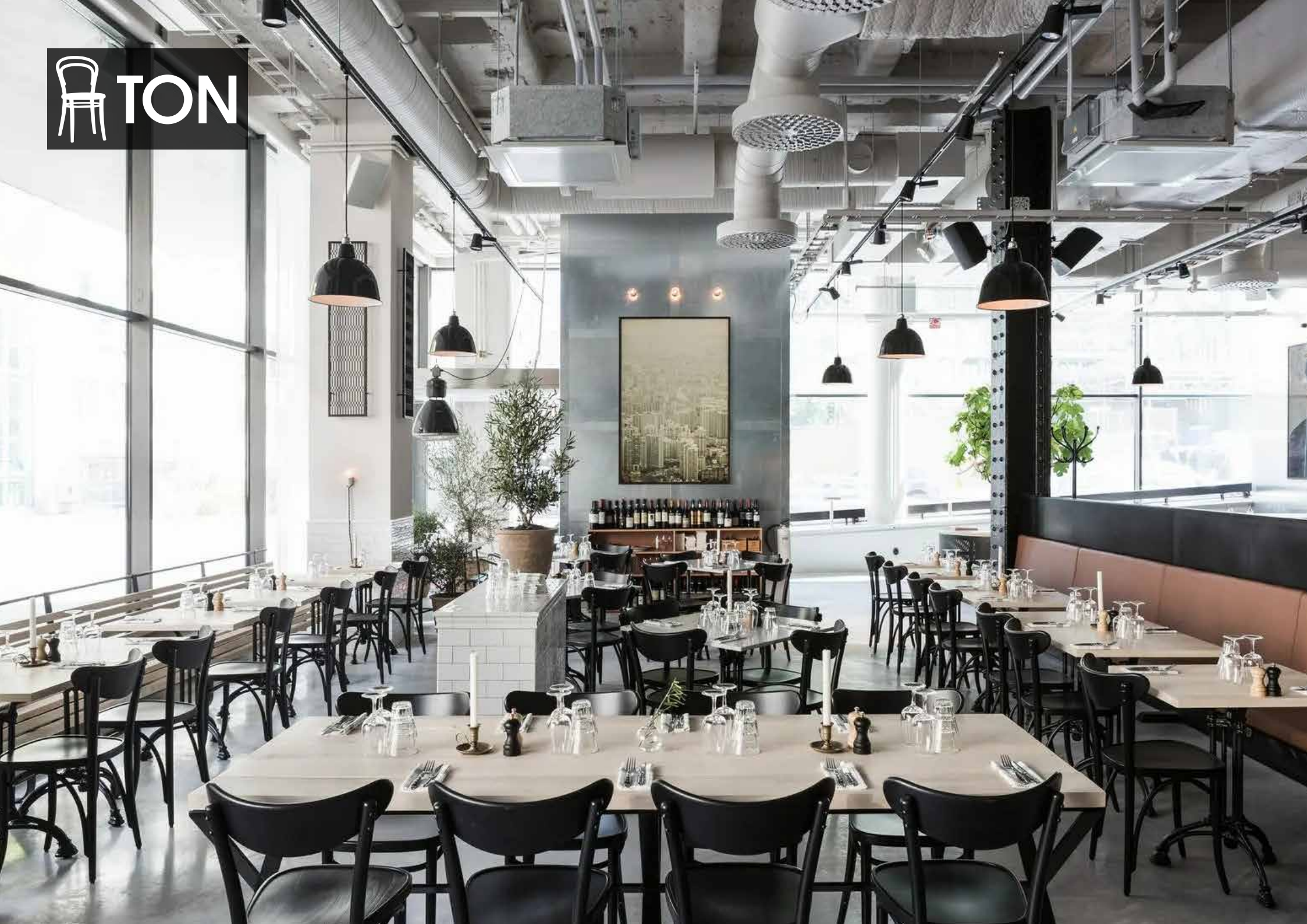



Abbildung / image	Artikel - Bezeichnung / description d'article	Preis Prix CHF												
 <p data-bbox="241 659 786 746">Gewicht/Poids: 4.7 kg Mindestbestellmenge und Verpackungseinheit: 2 Stk. Quantité minimum de commande et unité à: 2 pcs.</p>	<p data-bbox="898 245 1509 368"><b>PUNTON</b> Stuhl ohne Armlehne Erhältlich in Eiche und Buche, gebeizt nach Kollektion ohne Sitzpolster mit Sitzpolster, Stoffbezug gemäss Kollektion</p> <p data-bbox="898 413 1509 552"><b>PUNTON</b> chaise sans accoudoirs Disponible en chêne et en hêtre, teinté selon collection sans rembourrage d'assise avec rembourrage d'assise, tissu selon la collection</p> <table data-bbox="898 600 1615 738"> <tr> <td>Gesamtbreite (cm)</td> <td>Gesamttiefe (cm)</td> <td>Gesamthöhe (cm)</td> </tr> <tr> <td><b>52</b></td> <td><b>49</b></td> <td><b>75,5</b></td> </tr> <tr> <td>Sitzhöhe (cm)</td> <td>Sitzbreite (cm)</td> <td>Sitztiefe (cm)</td> </tr> <tr> <td><b>46</b></td> <td><b>Ø 40</b></td> <td><b>Ø 40</b></td> </tr> </table>	Gesamtbreite (cm)	Gesamttiefe (cm)	Gesamthöhe (cm)	<b>52</b>	<b>49</b>	<b>75,5</b>	Sitzhöhe (cm)	Sitzbreite (cm)	Sitztiefe (cm)	<b>46</b>	<b>Ø 40</b>	<b>Ø 40</b>	<p data-bbox="1984 308 2085 368">ab 359.- ab 419.-</p> <p data-bbox="1939 485 2130 545">à partir de 359.- à partir de 419.-</p>
Gesamtbreite (cm)	Gesamttiefe (cm)	Gesamthöhe (cm)												
<b>52</b>	<b>49</b>	<b>75,5</b>												
Sitzhöhe (cm)	Sitzbreite (cm)	Sitztiefe (cm)												
<b>46</b>	<b>Ø 40</b>	<b>Ø 40</b>												
 <p data-bbox="241 1289 427 1366">Petit 014 Mindestmenge 2 Quantité min. 2 pcs</p> <p data-bbox="580 1289 766 1366">Petit 114 Mindestmenge 1 Quantité min. 2 pcs</p>	<p data-bbox="898 847 1384 940"><b>PETIT 014</b> Kinderstuhl ohne Armlehne Erhältlich in Buche, gebeizt nach Kollektion 32 x 40.5 x 63 cm (BxTxH)</p> <p data-bbox="898 975 1447 1067"><b>PETIT 014</b> chaise pour enfants sans accoudoirs Disponible en hêtre, teinté selon collection 32 x 40.5 x 63 cm (LxPxH)</p> <p data-bbox="898 1134 1384 1227"><b>PETIT 114</b> Kinder/Hochstuhl mit Armlehne Erhältlich in Buche, gebeizt nach Kollektion 50 x 58.5 x 93 cm (BxTxH)</p> <p data-bbox="898 1262 1518 1355"><b>PETIT 114</b> chaise haute pour enfants avec accoudoirs Disponible en hêtre, teinté selon collection 50 x 58.5 x 93 cm (LxPxH)</p>	<p data-bbox="1973 890 2096 983">ab à partir de 359.-</p> <p data-bbox="1973 1174 2096 1267">ab à partir de 1'239.-</p>												







Abbildung / image	Artikel - Bezeichnung / description d'article	Preis Prix CHF																								
 <p data-bbox="241 651 792 740">Gewicht/Poids: 5.2 kg / 6.1 kg Mindestbestellmenge und Verpackungseinheit: 1 Stk. Quantité minimum de commande et unité à: 1 pcs.</p>	<p data-bbox="896 247 1680 316"><b>STOCKHOLM</b> Stuhl / Sessel ohne und mit Armlehne Erhältlich in Buche, gebeizt nach Kollektion, mit und ohne Polsterung</p> <table data-bbox="896 327 1601 486"> <tr> <td>Gesamtbreite (cm)</td> <td>Gesamttiefe (cm)</td> <td>Gesamthöhe (cm)</td> </tr> <tr> <td><b>49,5</b></td> <td><b>52,5</b></td> <td><b>83</b></td> </tr> <tr> <td>Sitzhöhe (cm)</td> <td>Sitzbreite (cm)</td> <td>Sitztiefe (cm)</td> </tr> <tr> <td><b>47</b></td> <td><b>40,5</b></td> <td><b>38</b></td> </tr> </table> <p data-bbox="896 523 1691 592"><b>STOCKHOLM</b> chaise / fauteuil sans et avec accoudoirs Disponible en hêtre, teinté selon collection, avec et sans rembourrage</p> <table data-bbox="896 603 1601 750"> <tr> <td>Gesamtbreite (cm)</td> <td>Gesamttiefe (cm)</td> <td>Gesamthöhe (cm)</td> </tr> <tr> <td><b>62</b></td> <td><b>52,5</b></td> <td><b>83</b></td> </tr> <tr> <td>Armlehne Höhe (cm)</td> <td>Sitzhöhe (cm)</td> <td>Sitzbreite (cm)</td> </tr> <tr> <td><b>70</b></td> <td><b>47</b></td> <td><b>40,5</b></td> </tr> </table>	Gesamtbreite (cm)	Gesamttiefe (cm)	Gesamthöhe (cm)	<b>49,5</b>	<b>52,5</b>	<b>83</b>	Sitzhöhe (cm)	Sitzbreite (cm)	Sitztiefe (cm)	<b>47</b>	<b>40,5</b>	<b>38</b>	Gesamtbreite (cm)	Gesamttiefe (cm)	Gesamthöhe (cm)	<b>62</b>	<b>52,5</b>	<b>83</b>	Armlehne Höhe (cm)	Sitzhöhe (cm)	Sitzbreite (cm)	<b>70</b>	<b>47</b>	<b>40,5</b>	<p data-bbox="1989 247 2112 347">ab à partir de 439.-</p>
Gesamtbreite (cm)	Gesamttiefe (cm)	Gesamthöhe (cm)																								
<b>49,5</b>	<b>52,5</b>	<b>83</b>																								
Sitzhöhe (cm)	Sitzbreite (cm)	Sitztiefe (cm)																								
<b>47</b>	<b>40,5</b>	<b>38</b>																								
Gesamtbreite (cm)	Gesamttiefe (cm)	Gesamthöhe (cm)																								
<b>62</b>	<b>52,5</b>	<b>83</b>																								
Armlehne Höhe (cm)	Sitzhöhe (cm)	Sitzbreite (cm)																								
<b>70</b>	<b>47</b>	<b>40,5</b>																								
 <p data-bbox="241 1300 792 1396">Gewicht/Poids: 4.0 kg Mindestbestellmenge und Verpackungseinheit: 2 Stk. Quantité minimum de commande et unité à: 2 pcs.</p>	<p data-bbox="896 826 1388 895"><b>PRAG</b> Stuhl ohne Armlehne Erhältlich in Buche, gebeizt nach Kollektion</p> <p data-bbox="896 938 1377 1007"><b>PRAG</b> chaise sans accoudoirs Disponible en hêtre, teinté selon collection</p> <table data-bbox="896 1050 1601 1204"> <tr> <td>Gesamtbreite (cm)</td> <td>Gesamttiefe (cm)</td> <td>Gesamthöhe (cm)</td> </tr> <tr> <td><b>44,2</b></td> <td><b>51</b></td> <td><b>79,5</b></td> </tr> <tr> <td>Sitzhöhe (cm)</td> <td>Sitzbreite (cm)</td> <td>Sitztiefe (cm)</td> </tr> <tr> <td><b>44,9</b></td> <td><b>40</b></td> <td><b>40</b></td> </tr> </table>	Gesamtbreite (cm)	Gesamttiefe (cm)	Gesamthöhe (cm)	<b>44,2</b>	<b>51</b>	<b>79,5</b>	Sitzhöhe (cm)	Sitzbreite (cm)	Sitztiefe (cm)	<b>44,9</b>	<b>40</b>	<b>40</b>	<p data-bbox="1989 826 2112 927">ab à partir de 459.-</p>												
Gesamtbreite (cm)	Gesamttiefe (cm)	Gesamthöhe (cm)																								
<b>44,2</b>	<b>51</b>	<b>79,5</b>																								
Sitzhöhe (cm)	Sitzbreite (cm)	Sitztiefe (cm)																								
<b>44,9</b>	<b>40</b>	<b>40</b>																								









Abbildung / image	Artikel - Bezeichnung / description d'article	Preis Prix CHF												
	<p><b>811</b> Stuhl ohne Armlehne Gestell Buche naturlackiert oder gebeizt nach Kollektion, Schilfrohrgeflecht Sperrholzsitz gemäss Kollektion, Gewicht: 4.7kg Polsterung gemäss Kollektion</p> <p><b>811</b> chaise sans accoudoirs Structure en hêtre naturel ou teinté selon collection, tresse de roseau Contreplaqué selon collection, poids: 4.7kg Rembourré selon collection</p> <table border="1" data-bbox="936 571 1637 775"> <tr> <td>Gesamtbreite (cm)</td> <td>Gesamttiefe (cm)</td> <td>Gesamthöhe (cm)</td> </tr> <tr> <td><b>45</b></td> <td><b>53,5</b></td> <td><b>80</b></td> </tr> <tr> <td>Sitzhöhe (cm)</td> <td>Sitzbreite (cm)</td> <td>Sitztiefe (cm)</td> </tr> <tr> <td><b>46</b></td> <td><b>45</b></td> <td><b>41</b></td> </tr> </table>	Gesamtbreite (cm)	Gesamttiefe (cm)	Gesamthöhe (cm)	<b>45</b>	<b>53,5</b>	<b>80</b>	Sitzhöhe (cm)	Sitzbreite (cm)	Sitztiefe (cm)	<b>46</b>	<b>45</b>	<b>41</b>	<p>ab 589.- ab 599.-</p> <p>à partir de 589.- 599.-</p>
Gesamtbreite (cm)	Gesamttiefe (cm)	Gesamthöhe (cm)												
<b>45</b>	<b>53,5</b>	<b>80</b>												
Sitzhöhe (cm)	Sitzbreite (cm)	Sitztiefe (cm)												
<b>46</b>	<b>45</b>	<b>41</b>												
	<p><b>811</b> Sessel mit Armlehne Gestell Buche naturlackiert oder gebeizt nach Kollektion, Schilfrohrgeflecht Sperrholzsitz gemäss Kollektion, Gewicht: 5.4kg Polsterung gemäss Kollektion</p> <p><b>811</b> fauteil avec accoudoirs Structure en hêtre naturel ou teinté selon collection, tresse de roseau Contreplaqué selon collection, Gewicht: 5.4kg Rembourré selon collection</p> <table border="1" data-bbox="936 1161 1688 1321"> <tr> <td>Gesamtbreite (cm)</td> <td>Gesamttiefe (cm)</td> <td>Gesamthöhe (cm)</td> </tr> <tr> <td><b>57</b></td> <td><b>51,5</b></td> <td><b>82</b></td> </tr> <tr> <td>Armlehne Höhe (cm)</td> <td>Sitzhöhe (cm)</td> <td>Sitzbreite (cm)</td> </tr> <tr> <td><b>66</b></td> <td><b>47</b></td> <td><b>41,6</b></td> </tr> </table>	Gesamtbreite (cm)	Gesamttiefe (cm)	Gesamthöhe (cm)	<b>57</b>	<b>51,5</b>	<b>82</b>	Armlehne Höhe (cm)	Sitzhöhe (cm)	Sitzbreite (cm)	<b>66</b>	<b>47</b>	<b>41,6</b>	<p>ab 759.- ab 769.-</p> <p>à partir de 759.- 769.-</p>
Gesamtbreite (cm)	Gesamttiefe (cm)	Gesamthöhe (cm)												
<b>57</b>	<b>51,5</b>	<b>82</b>												
Armlehne Höhe (cm)	Sitzhöhe (cm)	Sitzbreite (cm)												
<b>66</b>	<b>47</b>	<b>41,6</b>												







Abbildung / image	Artikel - Bezeichnung / description d'article	Preis Prix CHF												
	<p><b>822 Stuhl ohne Armlehne</b> Erhältlich in Buche, lackiert, gebeizt nach Kollektion</p> <p><b>822 chaise sans accoudoirs</b> Disponible en hêtre, lacqué, teinté selon collection</p> <table border="1" data-bbox="907 435 1435 486"> <thead> <tr> <th>Gesamtbreite (cm)</th> <th>Gesamttiefe (cm)</th> <th>Gesamthöhe (cm)</th> </tr> </thead> <tbody> <tr> <td>45</td> <td>52,4</td> <td>80,2</td> </tr> </tbody> </table> <table border="1" data-bbox="907 531 1435 582"> <thead> <tr> <th>Sitzhöhe (cm)</th> <th>Sitzbreite (cm)</th> <th>Sitztiefe (cm)</th> </tr> </thead> <tbody> <tr> <td>46</td> <td>45</td> <td>41</td> </tr> </tbody> </table> <p>Gewicht/Poids: 4.0 kg Mindestbestellmenge und Verpackungseinheit: 1 Stk. Quantité minimale de commande et unité à: 1 pcs.</p>	Gesamtbreite (cm)	Gesamttiefe (cm)	Gesamthöhe (cm)	45	52,4	80,2	Sitzhöhe (cm)	Sitzbreite (cm)	Sitztiefe (cm)	46	45	41	<p>ab 629.-</p> <p>à partir de 629.-</p>
Gesamtbreite (cm)	Gesamttiefe (cm)	Gesamthöhe (cm)												
45	52,4	80,2												
Sitzhöhe (cm)	Sitzbreite (cm)	Sitztiefe (cm)												
46	45	41												
	<p><b>822 Sessel mit Armlehne</b> Erhältlich in Buche, lackiert, gebeizt nach Kollektion</p> <p><b>822 chaise avec accoudoirs</b> Disponible en hêtre, lacqué, teinté selon collection</p> <table border="1" data-bbox="907 991 1435 1042"> <thead> <tr> <th>Gesamtbreite (cm)</th> <th>Gesamttiefe (cm)</th> <th>Gesamthöhe (cm)</th> </tr> </thead> <tbody> <tr> <td>50</td> <td>52,4</td> <td>80,2</td> </tr> </tbody> </table> <table border="1" data-bbox="907 1086 1435 1137"> <thead> <tr> <th>Armlehne Höhe (cm)</th> <th>Sitzhöhe (cm)</th> <th>Sitzbreite (cm)</th> </tr> </thead> <tbody> <tr> <td>64,7</td> <td>46</td> <td>45</td> </tr> </tbody> </table> <p>Gewicht/Poids: 4.6 kg Mindestbestellmenge und Verpackungseinheit: 1 Stk. Quantité minimale de commande et unité à: 1 pcs.</p>	Gesamtbreite (cm)	Gesamttiefe (cm)	Gesamthöhe (cm)	50	52,4	80,2	Armlehne Höhe (cm)	Sitzhöhe (cm)	Sitzbreite (cm)	64,7	46	45	<p>ab 839.-</p> <p>à partir de 839.-</p>
Gesamtbreite (cm)	Gesamttiefe (cm)	Gesamthöhe (cm)												
50	52,4	80,2												
Armlehne Höhe (cm)	Sitzhöhe (cm)	Sitzbreite (cm)												
64,7	46	45												

 TON







Abbildung / image	Artikel - Bezeichnung / description d'article	Preis Prix CHF												
	<p><b>VALENCIA</b> Stuhl ohne Armlehne Sperrholzsitz, Buche lackiert oder gebeizt nach Kollektion Sperrholzsitz, Eiche lackiert oder gebeizt nach Kollektion</p> <p><b>VALENCIA</b> chaise sans accoudoirs Siège en contreplaqué, hêtre lacqué ou teinté selon collection Siège en contreplaqué, chêne lacqué ou teinté selon collection</p> <table border="0"> <tr> <td>Gesamtbreite (cm)</td> <td>Gesamttiefe (cm)</td> <td>Gesamthöhe (cm)</td> </tr> <tr> <td><b>51</b></td> <td><b>54,5</b></td> <td><b>81</b></td> </tr> <tr> <td>Sitzhöhe (cm)</td> <td>Sitzbreite (cm)</td> <td>Sitztiefe (cm)</td> </tr> <tr> <td><b>45</b></td> <td><b>43</b></td> <td><b>47</b></td> </tr> </table> <p>Gewicht/Poids: 5.0 kg Mindestbestellmenge und Verpackungseinheit: 1 Stk. Quantité minimale de commande et unité à: 1 pcs.</p>	Gesamtbreite (cm)	Gesamttiefe (cm)	Gesamthöhe (cm)	<b>51</b>	<b>54,5</b>	<b>81</b>	Sitzhöhe (cm)	Sitzbreite (cm)	Sitztiefe (cm)	<b>45</b>	<b>43</b>	<b>47</b>	<p>ab 569.- ab 819.-</p> <p>à partir de 569.- à partir de 819.-</p>
Gesamtbreite (cm)	Gesamttiefe (cm)	Gesamthöhe (cm)												
<b>51</b>	<b>54,5</b>	<b>81</b>												
Sitzhöhe (cm)	Sitzbreite (cm)	Sitztiefe (cm)												
<b>45</b>	<b>43</b>	<b>47</b>												
	<p><b>VALENCIA</b> Stuhl ohne Armlehne gepolstert oder teilgepolstert Sperrholzsitz, Buche lackiert oder gebeizt nach Kollektion Sperrholzsitz, Eiche lackiert oder gebeizt nach Kollektion Stoff gemäss Kollektion</p> <p><b>VALENCIA</b> chaise sans accoudoirs rembourré ou partiellement rembourré Siège en contreplaqué, hêtre lacqué ou teinté selon collection Siège en contreplaqué, chêne lacqué ou teinté selon collection Tissu selon la collection</p> <table border="0"> <tr> <td>Gesamtbreite (cm)</td> <td>Gesamttiefe (cm)</td> <td>Gesamthöhe (cm)</td> </tr> <tr> <td><b>51</b></td> <td><b>54,5</b></td> <td><b>81</b></td> </tr> <tr> <td>Sitzhöhe (cm)</td> <td>Sitzbreite (cm)</td> <td>Sitztiefe (cm)</td> </tr> <tr> <td><b>45</b></td> <td><b>43</b></td> <td><b>47</b></td> </tr> </table> <p>Gewicht/Poids: 6.2 kg Mindestbestellmenge und Verpackungseinheit: 1 Stk. Quantité minimum de commande et unité à: 1 pcs.</p>	Gesamtbreite (cm)	Gesamttiefe (cm)	Gesamthöhe (cm)	<b>51</b>	<b>54,5</b>	<b>81</b>	Sitzhöhe (cm)	Sitzbreite (cm)	Sitztiefe (cm)	<b>45</b>	<b>43</b>	<b>47</b>	<p>ab 749.- ab 889.-</p> <p>à partir de 749.- à partir de 889.-</p>
Gesamtbreite (cm)	Gesamttiefe (cm)	Gesamthöhe (cm)												
<b>51</b>	<b>54,5</b>	<b>81</b>												
Sitzhöhe (cm)	Sitzbreite (cm)	Sitztiefe (cm)												
<b>45</b>	<b>43</b>	<b>47</b>												

 TON



1 BPM 01 + 02 + 16





Abbildung / image	Artikel - Bezeichnung / description d'article	Preis Prix CHF												
 <p data-bbox="241 683 792 775">Gewicht/Poids: 4.0 kg Mindestbestellmenge und Verpackungseinheit: 1 Stk. Quantité minimum de commande et unité à: 1 pcs.</p>	<p data-bbox="896 236 1509 360"><b>LEAF</b> Stuhl ohne Armlehne Erhältlich in Eiche und Buche, gebeizt nach Kollektion ohne Sitzpolster mit Sitzpolster, Stoffbezug gemäss Kollektion</p> <p data-bbox="896 395 1518 520"><b>LEAF</b> chaise sans accoudoirs Disponible en chêne et en hêtre, teinté selon collection sans rembourrage d'assise avec rembourrage d'assise, tissu selon la collection</p> <table data-bbox="896 555 1603 695"> <thead> <tr> <th>Gesamtbreite (cm)</th> <th>Gesamttiefe (cm)</th> <th>Gesamthöhe (cm)</th> </tr> </thead> <tbody> <tr> <td><b>50,5</b></td> <td><b>52</b></td> <td><b>80</b></td> </tr> <tr> <th>Sitzhöhe (cm)</th> <th>Sitzbreite (cm)</th> <th>Sitztiefe (cm)</th> </tr> <tr> <td><b>45,7</b></td> <td><b>43,5</b></td> <td><b>40</b></td> </tr> </tbody> </table>	Gesamtbreite (cm)	Gesamttiefe (cm)	Gesamthöhe (cm)	<b>50,5</b>	<b>52</b>	<b>80</b>	Sitzhöhe (cm)	Sitzbreite (cm)	Sitztiefe (cm)	<b>45,7</b>	<b>43,5</b>	<b>40</b>	<p data-bbox="1962 290 2065 354">ab 569.- ab 969.-</p> <p data-bbox="1917 466 2110 529">à partir de 569.- à partir de 969.-</p>
Gesamtbreite (cm)	Gesamttiefe (cm)	Gesamthöhe (cm)												
<b>50,5</b>	<b>52</b>	<b>80</b>												
Sitzhöhe (cm)	Sitzbreite (cm)	Sitztiefe (cm)												
<b>45,7</b>	<b>43,5</b>	<b>40</b>												
 <p data-bbox="241 1315 792 1407">Gewicht/Poids: 4.4 kg Mindestbestellmenge und Verpackungseinheit: 1 Stk. Quantité minimum de commande et unité à: 1 pcs.</p>	<p data-bbox="896 852 1509 976"><b>LEAF</b> Sessel mit Armlehne Erhältlich in Eiche und Buche, gebeizt nach Kollektion ohne Sitzpolster mit Sitzpolster, Stoffbezug gemäss Kollektion</p> <p data-bbox="896 1034 1518 1158"><b>LEAF</b> fauteuil avec accoudoirs Disponible en chêne et en hêtre, teinté selon collection sans rembourrage d'assise avec rembourrage d'assise, tissu selon la collection</p> <table data-bbox="896 1219 1603 1359"> <thead> <tr> <th>Gesamtbreite (cm)</th> <th>Gesamttiefe (cm)</th> <th>Gesamthöhe (cm)</th> </tr> </thead> <tbody> <tr> <td><b>59,5</b></td> <td><b>52</b></td> <td><b>80</b></td> </tr> <tr> <th>Armlehne Höhe (cm)</th> <th>Sitzhöhe (cm)</th> <th>Sitzbreite (cm)</th> </tr> <tr> <td><b>70</b></td> <td><b>45,7</b></td> <td><b>43,5</b></td> </tr> </tbody> </table>	Gesamtbreite (cm)	Gesamttiefe (cm)	Gesamthöhe (cm)	<b>59,5</b>	<b>52</b>	<b>80</b>	Armlehne Höhe (cm)	Sitzhöhe (cm)	Sitzbreite (cm)	<b>70</b>	<b>45,7</b>	<b>43,5</b>	<p data-bbox="1962 928 2065 992">ab 739.- ab 1'069.-</p> <p data-bbox="1917 1104 2110 1168">à partir de 739.- à partir de 1'069.-</p>
Gesamtbreite (cm)	Gesamttiefe (cm)	Gesamthöhe (cm)												
<b>59,5</b>	<b>52</b>	<b>80</b>												
Armlehne Höhe (cm)	Sitzhöhe (cm)	Sitzbreite (cm)												
<b>70</b>	<b>45,7</b>	<b>43,5</b>												

 TON





Abbildung / image	Artikel - Bezeichnung / description d'article	Preis Prix CHF												
 <p>Gewicht/Poids: 8.5 kg Mindestbestellmenge und Verpackungseinheit: 1 Stk. Quantité minimum de commande et unité à: 1 pcs.</p>	<p><b>MORITZ</b> Stuhl ohne Armlehne Erhältlich in Eiche und Buche, gebeizt nach Kollektion mit Polsterung, Sitzpolster mit Taschenfederung, Stoffbezug gemäss Kollektion</p> <p><b>MORITZ</b> chaise sans accoudoirs Disponible en chêne et en hêtre, teinté selon collection avec rembourrage, siège avec ressorts ensachés, tissu selon collection</p> <table border="1"> <tr> <td>Gesamtbreite (cm)</td> <td>Gesamttiefe (cm)</td> <td>Gesamthöhe (cm)</td> </tr> <tr> <td><b>46</b></td> <td><b>60</b></td> <td><b>82,5</b></td> </tr> <tr> <td>Sitzhöhe (cm)</td> <td>Sitzbreite (cm)</td> <td>Sitztiefe (cm)</td> </tr> <tr> <td><b>45,5</b></td> <td><b>46</b></td> <td><b>42</b></td> </tr> </table>	Gesamtbreite (cm)	Gesamttiefe (cm)	Gesamthöhe (cm)	<b>46</b>	<b>60</b>	<b>82,5</b>	Sitzhöhe (cm)	Sitzbreite (cm)	Sitztiefe (cm)	<b>45,5</b>	<b>46</b>	<b>42</b>	<p>ab à partir de 1'099.-</p>
Gesamtbreite (cm)	Gesamttiefe (cm)	Gesamthöhe (cm)												
<b>46</b>	<b>60</b>	<b>82,5</b>												
Sitzhöhe (cm)	Sitzbreite (cm)	Sitztiefe (cm)												
<b>45,5</b>	<b>46</b>	<b>42</b>												
 <p>Gewicht/Poids: 9.0 kg Mindestbestellmenge und Verpackungseinheit: 1 Stk. Quantité minimum de commande et unité à: 1 pcs.</p>	<p><b>MORITZ</b> Sessel mit Armlehne Erhältlich in Eiche und Buche, gebeizt nach Kollektion mit Polsterung, Sitzpolster mit Taschenfederung, Stoffbezug gemäss Kollektion</p> <p><b>MORITZ</b> fauteil avec accoudoirs Disponible en chêne et en hêtre, teinté selon collection avec rembourrage, siège avec ressorts ensachés, tissu selon la collection</p> <table border="1"> <tr> <td>Gesamtbreite (cm)</td> <td>Gesamttiefe (cm)</td> <td>Gesamthöhe (cm)</td> </tr> <tr> <td><b>57</b></td> <td><b>60</b></td> <td><b>82,5</b></td> </tr> <tr> <td>Armlehne Höhe (cm)</td> <td>Sitzhöhe (cm)</td> <td>Sitzbreite (cm)</td> </tr> <tr> <td><b>68</b></td> <td><b>45,5</b></td> <td><b>46</b></td> </tr> </table>	Gesamtbreite (cm)	Gesamttiefe (cm)	Gesamthöhe (cm)	<b>57</b>	<b>60</b>	<b>82,5</b>	Armlehne Höhe (cm)	Sitzhöhe (cm)	Sitzbreite (cm)	<b>68</b>	<b>45,5</b>	<b>46</b>	<p>ab à partir de 1'359.-</p>
Gesamtbreite (cm)	Gesamttiefe (cm)	Gesamthöhe (cm)												
<b>57</b>	<b>60</b>	<b>82,5</b>												
Armlehne Höhe (cm)	Sitzhöhe (cm)	Sitzbreite (cm)												
<b>68</b>	<b>45,5</b>	<b>46</b>												



Weitere Produkte aus der Moritz-Kollektion / aussi de la collection Moritz:





Informationen:  
MAZUVO Referenz: Bauarena Volketswil  
Konzeption und Planung:  
HAUSER UND PARTNER DÜBENDORF























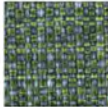

Abbildung / image	Artikel - Bezeichnung / description d'article	Preis Prix CHF												
 <p>Mindestbestellmenge und Verpackungseinheit: 1 Stk. Quantité minimum de commande et unité à: 1 pcs. Gewicht/Poids: 4.6 kg</p>	<p><b>MERANO</b> Stuhl ohne Armlehne, stapelbar / chaise sans accoudoirs, empilable</p> <p>Sperrholzsitz, Buche / Siège en contreplaqué, hêtre Buche gebeizt, gepolstert nach Kollektion / Hêtre teinté, rembourré selon collection</p> <p>Sperrholzsitz, Eiche natur lackiert od. geölt Siège en contreplaqué, chêne laqué/huilé</p> <p>Eiche gebeizt, gepolstert nach Kollektion / Chêne teinté, rembourré selon collection</p> <table border="0"> <tr> <td>Gesamtbreite (cm)</td> <td>Gesamttiefe (cm)</td> <td>Gesamthöhe (cm)</td> </tr> <tr> <td><b>49</b></td> <td><b>52,5</b></td> <td><b>79</b></td> </tr> <tr> <td>Sitzhöhe (cm)</td> <td>Sitzbreite (cm)</td> <td>Sitztiefe (cm)</td> </tr> <tr> <td><b>45</b></td> <td><b>43,6</b></td> <td><b>42</b></td> </tr> </table>	Gesamtbreite (cm)	Gesamttiefe (cm)	Gesamthöhe (cm)	<b>49</b>	<b>52,5</b>	<b>79</b>	Sitzhöhe (cm)	Sitzbreite (cm)	Sitztiefe (cm)	<b>45</b>	<b>43,6</b>	<b>42</b>	<p>ab à partir de 539.- 619.- 769.-</p> <p>ab à partir de 829.-</p>
Gesamtbreite (cm)	Gesamttiefe (cm)	Gesamthöhe (cm)												
<b>49</b>	<b>52,5</b>	<b>79</b>												
Sitzhöhe (cm)	Sitzbreite (cm)	Sitztiefe (cm)												
<b>45</b>	<b>43,6</b>	<b>42</b>												
 <p>Mindestbestellmenge und Verpackungseinheit: 1 Stk. Quantité minimum de commande et unité à: 1 pcs. Gewicht/Poids: 6.5 kg</p>	<p><b>MERANO</b> Sessel mit Armlehne, fauteuil avec accoudoirs</p> <p>Sperrholzsitz, Buche natur lackiert / Siège en contreplaqué, hêtre lacqué Buche gebeizt, gepolstert nach Kollektion / Hêtre teinté, rembourré selon collection</p> <p>Sperrholzsitz, Eiche natur lackiert od. geölt Siège en contreplaqué, chêne laqué/huilé</p> <p>Eiche gebeizt, gepolstert nach Kollektion / Chêne teinté, rembourré selon coll.</p> <table border="0"> <tr> <td>Gesamtbreite (cm)</td> <td>Gesamttiefe (cm)</td> <td>Gesamthöhe (cm)</td> </tr> <tr> <td><b>54</b></td> <td><b>58</b></td> <td><b>78</b></td> </tr> <tr> <td>Armlehne Höhe (cm)</td> <td>Sitzhöhe (cm)</td> <td>Sitzbreite (cm)</td> </tr> <tr> <td><b>66</b></td> <td><b>45</b></td> <td><b>47,5</b></td> </tr> </table>	Gesamtbreite (cm)	Gesamttiefe (cm)	Gesamthöhe (cm)	<b>54</b>	<b>58</b>	<b>78</b>	Armlehne Höhe (cm)	Sitzhöhe (cm)	Sitzbreite (cm)	<b>66</b>	<b>45</b>	<b>47,5</b>	<p>669.-</p> <p>ab / à partir de 779.-</p> <p>1'059.-</p> <p>ab / à partir de 1'169.-</p>
Gesamtbreite (cm)	Gesamttiefe (cm)	Gesamthöhe (cm)												
<b>54</b>	<b>58</b>	<b>78</b>												
Armlehne Höhe (cm)	Sitzhöhe (cm)	Sitzbreite (cm)												
<b>66</b>	<b>45</b>	<b>47,5</b>												



**SCAB**  **DESIGN**  
since 1957

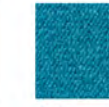





















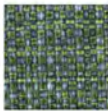





Abbildung / image	Artikel - Bezeichnung / description d'article	Preis Prix CHF
	<p><b>LISA 2850</b>                  Sessel mit Armlehne / fauteuil avec accoudoirs                  Sitz- und Rückenlehne mit geschwungenem Sperrholzkern                  Gestell aus Stahlrohr Ø 16mm, Gewicht: 8.0kg</p> <p>Assise et dossier avec cœur en contreplaqué courbé                  Structure en tube d'acier Ø 16mm, poids: 8.0kg</p> <div style="display: flex; justify-content: space-around; align-items: flex-start;"> <div style="text-align: center;">   <b>FS</b>                      faggio                      sbiancato                      bleached                      beech wood                 </div> <div style="text-align: center;">   <b>NC</b>                      noce                      canaletto                      american                      walnut wood                 </div> <div style="text-align: center;">   <b>RN</b>                      rovere                      naturale                      natural oak                      wood                 </div> <div style="text-align: center;">   <b>NR</b>                      rovere nero                      black oak                      wood                 </div> </div> <div style="margin-top: 20px;"> <p>Gestellvarianten:</p> <div style="display: flex; justify-content: space-around;"> <div style="text-align: center;">   <b>CR</b>                      cromato                      chromed                 </div> <div style="text-align: center;">   <b>VA</b>                      verniciato                      antracite                      anthracite                      grey coated                 </div> </div> <div style="display: flex; justify-content: space-around; margin-top: 10px;"> <div style="text-align: center;">   <b>OS</b>                      effetto ottone                      satinato                      satin brass                      effect                 </div> <div style="text-align: center;">   <b>NL</b>                      nichel nero                      lucido                      glossy black                      nikel                 </div> </div> </div>	<p>ab à partir de 359.-</p>
	<p><b>LISA 2851</b>                  Sessel mit Armlehne / fauteuil avec accoudoirs                  Polsterung: Stoffe, Kunstleder und Samt. Gestell aus Stahlrohr Ø 16mm                  Rembourrage: Tissus, similicuir et velours. Structure: en tube d'acier Ø 16mm                  Gewicht/poids: 8.4kg</p> <p><b>Beispiele erhältlichliche Stoffe / Exemples de tissu disponibles:</b></p> <div style="display: flex; justify-content: space-around; align-items: flex-start;"> <div style="text-align: center;">   <b>T5 26</b> </div> <div style="text-align: center;">   <b>T5 27</b> </div> <div style="text-align: center;">   <b>M2 09</b>                      idrorepellente                      water repellent                 </div> <div style="text-align: center;">   <b>T3 25</b>                      ignifugo                      fire retardant                 </div> </div> <div style="display: flex; justify-content: space-around; margin-top: 10px;"> <div style="text-align: center;">   <b>V4 38</b> </div> <div style="text-align: center;">   <b>V4 39</b> </div> <div style="text-align: center;">   <b>V4 40</b> </div> <div style="text-align: center;">   <b>V4 44</b> </div> <div style="text-align: center;">   <b>V4 47</b> </div> <div style="text-align: center;">   <b>V4 50</b> </div> </div> <div style="margin-top: 20px;"> <p>Gestellvarianten:</p> <div style="display: flex; justify-content: space-around;"> <div style="text-align: center;">   <b>CR</b>                      cromato                      chromed                 </div> <div style="text-align: center;">   <b>VA</b>                      verniciato                      antracite                      anthracite                      grey coated                 </div> </div> <div style="display: flex; justify-content: space-around; margin-top: 10px;"> <div style="text-align: center;">   <b>OS</b>                      effetto ottone                      satinato                      satin brass                      effect                 </div> <div style="text-align: center;">   <b>NL</b>                      nichel nero                      lucido                      glossy black                      nikel                 </div> </div> </div>	<p>ab à partir de 429.-</p>

SCAB  DESIGN  
since 1957













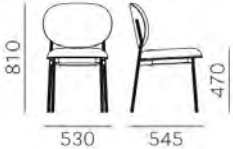

Abbildung / image	Artikel - Bezeichnung / description d'article	Preis Prix CHF
	<p><b>LISA 2852</b>                  Stuhl ohne Armlehne / chaise sans accoudoirs                  Sitz und Rückenlehne aus gebogenem Sperrholz                  Gestell aus Stahlrohr Ø 16mm, Gewicht: 8.1kg                  Assise et dossier avec coeur en contreplaqué courbé                  Structure en tube d'acier Ø 16mm, poids: 8.1kg</p> <div style="display: flex; justify-content: space-around; align-items: flex-start;"> <div style="text-align: center;">   <b>FS</b>                      faggio                      sbiancato                      bleached                      beech wood                 </div> <div style="text-align: center;">   <b>NC</b>                      noce                      canaletto                      american                      walnut wood                 </div> <div style="text-align: center;">   <b>RN</b>                      rovere                      naturale                      natural oak                      wood                 </div> <div style="text-align: center;">   <b>NR</b>                      rovere nero                      black oak                      wood                 </div> </div> <div style="margin-top: 20px;"> <p>Gestellfarben:</p> <div style="display: flex; justify-content: space-around;"> <div style="text-align: center;">   <b>CR</b>                      cromato                      chromed                 </div> <div style="text-align: center;">   <b>VA</b>                      verniciato                      antracite                      anthracite                      grey coated                 </div> </div> <div style="display: flex; justify-content: space-around; margin-top: 10px;"> <div style="text-align: center;">   <b>OS</b>                      effetto ottone                      satinato                      satin brass                      effect                 </div> <div style="text-align: center;">   <b>NL</b>                      nichel nero                      lucido                      glossy black                      nikel                 </div> </div> </div>	<p>ab à partir de 329.-</p>
	<p><b>LISA 2853</b>                  Stuhl ohne Armlehne / chaise sans accoudoirs                  Polsterung: Stoffe, Kunstleder und Samt. Gestell aus Stahlrohr Ø 16mm                  Rembourrage: Tissus, similicuir et velours. Structure en tube d'acier Ø 16mm                  Gewicht/poids: 8.3kg</p> <p><b>Beispiele erhältliche Stoffe / Exemples de tissu disponibles:</b></p> <div style="display: flex; justify-content: space-around; align-items: flex-start;"> <div style="text-align: center;">   <b>T5 26</b> </div> <div style="text-align: center;">   <b>T5 27</b> </div> <div style="text-align: center;">   <b>M2 09</b>                      idrorepellente                      water repellent                 </div> <div style="text-align: center;">   <b>T3 25</b>                      ignifugo                      fire retardant                 </div> </div> <div style="display: flex; justify-content: space-around; margin-top: 10px;"> <div style="text-align: center;">   <b>V4 38</b> </div> <div style="text-align: center;">   <b>V4 39</b> </div> <div style="text-align: center;">   <b>V4 40</b> </div> <div style="text-align: center;">   <b>V4 44</b> </div> <div style="text-align: center;">   <b>V4 47</b> </div> <div style="text-align: center;">   <b>V4 50</b> </div> </div> <div style="margin-top: 20px;"> <p>Gestellfarben:</p> <div style="display: flex; justify-content: space-around;"> <div style="text-align: center;">   <b>CR</b>                      cromato                      chromed                 </div> <div style="text-align: center;">   <b>VA</b>                      verniciato                      antracite                      anthracite                      grey coated                 </div> </div> <div style="display: flex; justify-content: space-around; margin-top: 10px;"> <div style="text-align: center;">   <b>OS</b>                      effetto ottone                      satinato                      satin brass                      effect                 </div> <div style="text-align: center;">   <b>NL</b>                      nichel nero                      lucido                      glossy black                      nikel                 </div> </div> </div>	<p>ab à partir de 389.-</p>

**PEDRALI**®



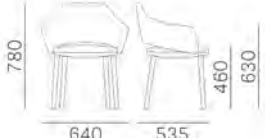



Abbildung / image	Artikel - Bezeichnung / description d'article	Preis Prix CHF
	<p><b>BLUME 2950</b> Stuhl ohne Armlehne, chaise sans accoudoirs                      Gestell: Aluminium                      Structure: aluminium</p>  <p>BS OA GG NE</p>   <p>Mindestbestellmenge: 1 Stk. / quantité minimale: 1 pcs.</p>	<p>ab à partir de 829.-</p>
 <p>auch als Variante mit Edelstahl Stuhlbeinen (pulverbeschichtet) erhältlich                      aussi disponible en variante avec des pieds de chaise en inox (thermolaqué)</p>	<p><b>VIC 655</b> Stuhl ohne Armlehne, chaise sans accoudoirs                      Eschenholz mit Aluminiumverstärkung                      Bois de frêne avec renforcement en aluminium</p> <p><b>VIC 645</b> Sessel mit Armlehne, fauteuil avec accoudoirs                      Eschenholz mit Aluminiumverstärkung                      Bois de frêne avec renforcement en aluminium</p> <p><b>Farben / couleurs:</b>                      WOODEN FINISHES / Finiture legno</p>  <p>FR N1 GC AN</p>     <p>Mindestbestellmenge: 1 Stk. / quantité minimale: 1 pcs.</p>	<p>ab à partir de 949.-</p> <p>ab à partir de 999.-</p>

**PEDRALI**®



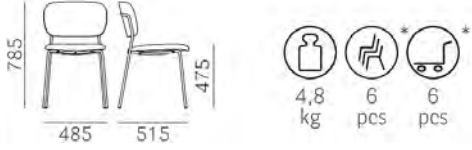

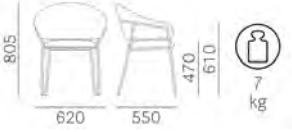
Abbildung / image	Artikel - Bezeichnung / description d'article	Preis Prix CHF
	<p><b>JAZZ 3719</b> Stuhl ohne Armlehne, chaise sans accoudoirs            Polsterung: Stoffe, Kunstleder und Samt.            Gestell aus Stahlrohr Ø 16mm            Rembourrage: Tissus, similicuir et velours.            Structure: en tube d'acier Ø 16mm</p>  <p>Mindestbestellmenge: 1 Stk. / quantité minimale: 1 pcs.</p>	<p>ab à partir de 379.-</p>
	<p><b>JAZZ 3716</b> Sessel mit Armlehne, fauteuil avec accoudoirs            Polsterung: Stoffe, Kunstleder und Samt.            Gestell aus Stahlrohr Ø 16mm            Rembourrage: Tissus, similicuir et velours.            Structure: en tube d'acier Ø 16mm</p>  <p>Mindestbestellmenge: 1 Stk. / quantité minimale: 1 pcs.</p>	<p>ab à partir de 639.-</p>



et al.

**Informationen:**

Barhocker KICCA siehe Seite 73

Tabouret de bar KICCA voir page 73



Abbildung / image	Artikel - Bezeichnung / description d'article	Preis Prix CHF
	<p><b>KICCA 571</b> Armlehnstuhl, Sitzfläche und Rückenlehne gepolstert Gestell mit 4 Holzbeinen (Buche)</p> <p><b>KICCA 571</b> Fauteuil, assise et dossier rembourrés Piètement 4 pieds en hêtre massif</p> <p><b>Diverse Polsterungen möglich / divers rembourrages possible</b></p> <p>Mindestbestellmenge: 4 Stk. / quantité minimale: 1 pcs Gewicht / poids: 9.9 kg Verpackungseinheit / unité à: 1</p>	<p>ab à partir de 689.-</p>
	<p><b>KICCA 020</b> Armlehnstuhl, Sitzfläche und Rückenlehne gepolstert Gestell mit 4-beinigem Stahlgestell</p> <p><b>KICCA 020</b> Fauteuil, assise et dossier rembourrés Cadre à 4 pieds en acier</p> <p><b>Diverse Polsterungen möglich / divers rembourrages possible</b></p> <p>Mindestbestellmenge: 1 Stk. / quantité minimale: 1 pcs Gewicht / poids: 9.7 kg Verpackungseinheit / unité à: 1</p>	<p>ab à partir de 529.-</p>



Ein minimalistisch gestalteter Sessel, passend zum Esstisch, in Wohnräume oder als Raumsolitär. Der Sitz mit dem Detail des freigelegten Massivholzes wird von einer höheren Vollpolsterlehne umfasst. Auf deren Fläche sind die Abschlüsse des gespalteten, in die gegenläufigen Richtungen gebogenen Holzes zu sehen.

Un fauteuil de conception minimaliste approprié à une table pour prendre les repas, dans les pièces de séjour ou comme solitaire. L'assise présentant un détail découvert en bois massif, est enlacée par un dossier entièrement tapissé. Sa surface souligne bien les extrémités en bois fissuré, courbé en sens inverse.



Abbildung / image	Artikel - Bezeichnung / description d'article	Preis Prix CHF												
	<p><b>SPLIT</b> Sessel mit Armlehne Sperrholzsitz, Buche lackiert oder gebeizt nach Kollektion Sperrholzsitz, Esche lackiert oder gebeizt nach Kollektion Stoff Auswahl nach Kollektion</p> <p><b>SPLIT</b> fauteuil avec accoudoirs Siège en contreplaqué, hêtre lacqué ou teinté selon collection Siège en contreplaqué, frêne laqué ou teinté selon collection Sélection de tissus par collection</p> <table border="0"> <tr> <td>Gesamtbreite (cm)</td> <td>Gesamttiefe (cm)</td> <td>Gesamthöhe (cm)</td> </tr> <tr> <td><b>62</b></td> <td><b>63</b></td> <td><b>78</b></td> </tr> <tr> <td>Armlehne Höhe (cm)</td> <td>Sitzhöhe (cm)</td> <td>Sitzbreite (cm)</td> </tr> <tr> <td><b>67,5</b></td> <td><b>48</b></td> <td><b>47</b></td> </tr> </table> <p>Mindestbestellmenge und Verpackungseinheit: 1 Stk. Quantité minimum de commande et unité à: 1 pcs. Gewicht / poids: 12.5 kg</p>	Gesamtbreite (cm)	Gesamttiefe (cm)	Gesamthöhe (cm)	<b>62</b>	<b>63</b>	<b>78</b>	Armlehne Höhe (cm)	Sitzhöhe (cm)	Sitzbreite (cm)	<b>67,5</b>	<b>48</b>	<b>47</b>	<p>ab 2'079.- ab 2'189.-</p> <p>à partir de 2'079.- à partir de 2'189.-</p>
Gesamtbreite (cm)	Gesamttiefe (cm)	Gesamthöhe (cm)												
<b>62</b>	<b>63</b>	<b>78</b>												
Armlehne Höhe (cm)	Sitzhöhe (cm)	Sitzbreite (cm)												
<b>67,5</b>	<b>48</b>	<b>47</b>												



**PEDRALI**®









Abbildung / image	Artikel - Bezeichnung / description d'article	Preis Prix CHF
	<p><b>KUADRA 1321</b> Stuhl ohne Armlehne, chaise sans accoudoirs                  Stapelbar, Schale aus Sperrholz Eiche. Gestell aus viereckigem Stahlrohr                  20x20mm. Satiniert, verchromt oder pulverbeschichtet.                  Chaise empilable avec coque en conterplaqué chêne blanchi.                  Pièds 20x20mm disponible satinée, chromée ou époxy.</p> <p><b>Farben Sitzschale / couleurs siège:</b></p>  <p>Eiche geb.      wenge      schwarz                  chêne blan.    wengé      noir</p> <p><b>Zubehör: Reihenverbindung / accessoire: raccordement de siège</b></p> <p>Mindestbestellmenge: 4 Stk. / quantité minimale: 4 pcs.</p>	<p>ab à partir de 229.-</p> <p>3.-</p>
	<p><b>KUADRA 1331</b> Stuhl ohne Armlehne, chaise sans accoudoirs                  Stapelbar, Schale aus Zebrano Furnier erster Qualität.                  Rundrohrgestell Durchmesser 16mm verchromt.                  Chaise empilable plaquée en zebrano, essence prisée et résistante avec striures                  particulières. Pièds diamètre 16mm chromée</p> <p><b>Farben Sitzschale / couleurs siège:</b></p>  <p>Eiche geb.      wenge      schwarz                  chêne blan.    wengé      noir</p> <p><b>Zubehör: Reihenverbindung / accessoire: raccordement de siège</b></p> <p>Mindestbestellmenge: 4 Stk. / quantité minimale: 4 pcs.</p>	<p>ab à partir de 199.-</p> <p>3.-</p>



Abbildung / image	Artikel - Bezeichnung / description d'article	Preis Prix CHF
	<p><b>KUADRA 1051</b>                      Stuhl ohne Armlehnen, chaise sans accoudoirs                      Stapelbarer Stuhl mit gepolsterter Sitzschale bezogen mit Stoff oder Kunstleder und Struktur aus Stahlrohr Ø 16mm. Chaise empilable avec coque rembourrée recouverte de tissu ou de simili cuir et structure en tube d'acier Ø 16mm.</p> <p><b>Zubehör: Reihenverbindung / accessoire: raccordement de siège</b>                      Mindestbestellmenge: 2 Stk. / quantité minimale: 2 pcs.</p>	<p>ab à partir de 269.-</p> <p>3.-</p>
	<p><b>KUADRA 1055</b>                      Sessel mit Armlehne, chaise avec accoudoirs                      Stapelbarer Stuhl mit gepolsterter Sitzschale bezogen mit Stoff oder Kunstleder und Struktur aus Stahlrohr Ø 16mm. Chaise empilable avec coque rembourrée recouverte de tissu ou de simili cuir et structure en tube d'acier Ø 16mm.</p> <p><b>Zubehör: Reihenverbindung / accessoire: raccordement de siège</b>                      Mindestbestellmenge: 2 Stk. / quantité minimale: 2 pcs.</p>	<p>ab à partir de 309.-</p> <p>3.-</p>











Abbildung / image	Artikel - Bezeichnung / description d'article	Preis Prix CHF
 <p>Mindestbestellmenge: 10 Stk. / quantité minimale: 10 pcs.</p>	<p><b>KUADRA 2419 XL</b>                  Stuhl stapelbar mit Schale 12mm, aus mehrschichtigem Holz                  Kufengestell aus Stahlrohr verchromt 10mm                  Chaise empilable avec coque de 12mm en conterplaqué                  Piéds en tube d'acier chromé Ø 10mm</p> <p>Stapelmenge / quantité d'empilement: 8                  Gewicht / poids: 5.8 kg                  Verpackungseinheit / unité à: 2</p> <p><b>Farben Sitzschale / couleurs siège:</b></p> <div style="display: flex; justify-content: space-around; align-items: center;"> <div style="text-align: center;">                       Eiche geb. chêne blan.                 </div> <div style="text-align: center;">                       wenge wengé                 </div> <div style="text-align: center;">                       schwarz noir                 </div> </div>	<p>ab à partir de 209.-</p>
 <p>Mindestbestellmenge: 10 Stk. / quantité minimale: 10 pcs.</p>	<p><b>KUADRA 2413 XL</b>                  Stuhl XL mit Schale aus Furnierholz. Verschiedenen Rücklehnen Varianten gemäss                  Kollektion. Mit verchromtem Rundrohrgestell Ø 16mm aus Edelstahl. Stapelbar</p> <p>Chaise XL avec coque en conterplaqué. Trous géométriques sur le dossier selon                  collection. Piéds en tube d'acier Ø 16mm chromée. Empilable.</p> <p>Stapelmenge / quantité d'empilement: 8                  Gewicht / poids: 5.3 kg                  Verpackungseinheit / unité à: 2</p> <p><b>Farben Sitzschale / couleurs siège:</b></p> <div style="display: flex; justify-content: space-around; align-items: center;"> <div style="text-align: center;">                       Eiche geb. chêne blan.                 </div> <div style="text-align: center;">                       wenge wengé                 </div> <div style="text-align: center;">                       schwarz noir                 </div> </div>	<p>ab à partir de 199.-</p>

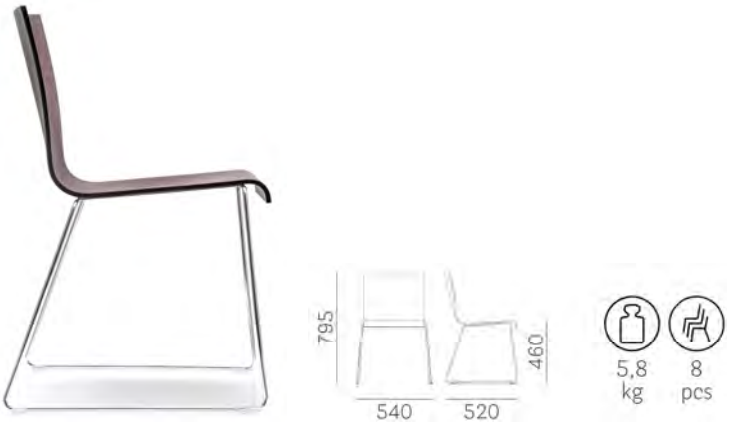



Abbildung / image	Artikel - Bezeichnung / description d'article	Preis Prix CHF
 <p data-bbox="246 550 380 582">Airolo Typ A</p> <p data-bbox="705 550 840 582">Airolo Typ C</p>	<p data-bbox="952 215 1668 279"><b>AIROLO TYP A</b> Stuhl ohne Armlehne / chaise sans accoudoirs <b>AIROLO TYP C</b> Stuhl ohne Armlehne / chaise sans accoudoirs</p> <p data-bbox="952 311 1803 375">Gestell: Stahlrohr 20mm verchromt, structure: tube d'acier 20mm chromé Sitzschale aus Sperrholz / siège conterplaqué</p> <p data-bbox="952 406 1411 438">Reihenverbindung / raccordement siège</p> <p data-bbox="952 470 1198 502">Gewicht / poids: 5.9 kg</p> <p data-bbox="963 542 1164 590"><b>MAZUVO</b></p>	<p data-bbox="2004 223 2072 255">169.-</p> <p data-bbox="2004 414 2049 446">3.-</p>
	<p data-bbox="952 614 1635 710"><b>TREND 444</b> Stuhl ohne Armlehne / chaise sans accoudoirs Stapelbar, Rundrohrgestell Durchmesser 16mm, verchromt Chaise empilable, pieds diamètre 16mm, chromés</p> <p data-bbox="952 726 1366 758"><b>Farben Sitzschale / couleurs siège:</b></p> <div data-bbox="963 774 1310 877">  </div> <p data-bbox="963 885 1299 941">Eiche gebel. wenge schwarz chêne blan. wengé noir</p> <p data-bbox="952 965 1523 997">Mindestbestellmenge: 2 Stk. / quantité minimale: 2pcs.</p>	<p data-bbox="1971 646 2094 750">ab à partir de 189.-</p>
	<p data-bbox="952 1037 1635 1133"><b>INGA 5613</b> Stuhl ohne Armlehne / chaise sans accoudoirs Stapelbar, Rundrohrgestell Durchmesser 16mm, verchromt Chaise empilable, pieds diamètre 16mm, chromés</p> <p data-bbox="952 1157 1366 1189"><b>Farben Sitzschale / couleurs siège:</b></p> <div data-bbox="963 1197 1310 1300">  </div> <p data-bbox="963 1308 1299 1364">Eiche gebel. wenge schwarz chêne blan. wengé noir</p> <p data-bbox="952 1380 1523 1412">Mindestbestellmenge: 2 Stk. / quantité minimale: 2 pcs.</p>	<p data-bbox="1971 1069 2094 1173">ab à partir de 219.-</p>







Abbildung / image	Artikel - Bezeichnung / description d'article	Preis Prix CHF												
 <p>(Feuer Resistent / resistant au feu)</p> 	<p><b>ALICE 2675</b> Stuhl ohne Armlehne, Schale technopolymer  <b>ALICE 2675</b> chaise sans accoudoirs, coque en technopolymere</p> <p><b>Stuhlbeine / piètement:</b>                  Stahlrohr 16 mm verchromt, tube d'acier chromé                  Option: verzinkt und pulverbeschichtet / galvanisé, thermolaqué</p> <p><b>Farben Sitzschale / couleur siège:</b></p> <table border="0"> <tr> <td></td> <td></td> <td></td> <td></td> <td></td> <td></td> </tr> <tr> <td>leinen lin</td> <td>taupe taupe</td> <td>rot rouge</td> <td>anthrazit anthracite</td> <td>grau gris</td> <td>braun brun</td> </tr> </table> <p>Stapelmenge / quantité d'empilement: 8                  Gewicht / poids: 5.3 kg                  Verpackungseinheit / unité à: 4</p> <p><b>Variante Feuerresistent / variante resistant au feu</b>                  Mindestbestellmenge: 4 Stk. / quantité minimale: 4 pcs</p>							leinen lin	taupe taupe	rot rouge	anthrazit anthracite	grau gris	braun brun	<p>109.-</p> <p>159.-</p>
leinen lin	taupe taupe	rot rouge	anthrazit anthracite	grau gris	braun brun									
 <p>Mindestbestellmenge: 20 Stk. / quantité minimale: 20 pcs.</p>	<p><b>ALICE 2677</b> Kufen Stuhl ohne Armlehne, Schale technopolymer  <b>ALICE 2677</b> chaise pied luge sans accoudoirs, coque en technopolymere</p> <p><b>Stuhlbeine / piètement:</b>                  Stahlrohr 11 mm verchromt, tube d'acier chromé                  Option: verzinkt und pulverbeschichtet / galvanisé, thermolaqué</p> <p><b>Farben Sitzschale / couleur siège:</b></p> <table border="0"> <tr> <td></td> <td></td> <td></td> <td></td> <td></td> <td></td> </tr> <tr> <td>leinen lin</td> <td>taupe taupe</td> <td>rot rouge</td> <td>anthrazit anthracite</td> <td>grau gris</td> <td>braun brun</td> </tr> </table> <p>Stapelmenge / quantité d'empilement: 4                  Gewicht / poids: 7.0 kg                  Verpackungseinheit / unité à: 2</p>							leinen lin	taupe taupe	rot rouge	anthrazit anthracite	grau gris	braun brun	<p>139.-</p>
leinen lin	taupe taupe	rot rouge	anthrazit anthracite	grau gris	braun brun									





Abbildung / image	Artikel - Bezeichnung / description d'article	Preis Prix CHF												
	<p><b>CHIPS</b> Lounge Sessel Gestell: aus Buche oder Eschenholz Diverse Polsterungen möglich</p> <p><b>CHIPS</b> Lounge fauteuil bas Structure: disponible en bois de hêtre ou de frêne Différents rembourrages possibles</p> <table border="0" data-bbox="882 549 1823 683"> <tr> <td>Gesamtbreite (cm)</td> <td>Gesamttiefe (cm)</td> <td>Gesamthöhe (cm)</td> </tr> <tr> <td><b>94,6</b></td> <td><b>89,5</b></td> <td><b>120,5</b></td> </tr> <tr> <td>Sitzhöhe (cm)</td> <td>Sitzbreite (cm)</td> <td>Sitztiefe (cm)</td> </tr> <tr> <td><b>35,5</b></td> <td><b>94,6</b></td> <td><b>72,5</b></td> </tr> </table> <p>Gewicht/poids: 20 kg Mindestbestellmenge und Verpackungseinheit: 1 Stk. Quantité minimum de commande et unité à: 1 pcs</p>	Gesamtbreite (cm)	Gesamttiefe (cm)	Gesamthöhe (cm)	<b>94,6</b>	<b>89,5</b>	<b>120,5</b>	Sitzhöhe (cm)	Sitzbreite (cm)	Sitztiefe (cm)	<b>35,5</b>	<b>94,6</b>	<b>72,5</b>	<p>ab à partir de 4'179.-</p>
Gesamtbreite (cm)	Gesamttiefe (cm)	Gesamthöhe (cm)												
<b>94,6</b>	<b>89,5</b>	<b>120,5</b>												
Sitzhöhe (cm)	Sitzbreite (cm)	Sitztiefe (cm)												
<b>35,5</b>	<b>94,6</b>	<b>72,5</b>												
	<p><b>CHIPS</b> Lounge Hocker Gestell: aus Buche oder Eschenholz Diverse Polsterungen möglich</p> <p><b>CHIPS</b> Lounge tabouret Structure: disponible en bois de hêtre ou de frêne Différents rembourrages possibles</p> <table border="0" data-bbox="882 1171 1823 1235"> <tr> <td>Gesamtbreite (cm)</td> <td>Gesamttiefe (cm)</td> <td>Gesamthöhe (cm)</td> </tr> <tr> <td><b>94</b></td> <td><b>60</b></td> <td><b>47</b></td> </tr> </table> <p>Gewicht/poids: 12 kg Mindestbestellmenge und Verpackungseinheit: 1 Stk. Quantité minimum de commande et unité à: 1 pcs</p>	Gesamtbreite (cm)	Gesamttiefe (cm)	Gesamthöhe (cm)	<b>94</b>	<b>60</b>	<b>47</b>	<p>ab à partir de 1'219.-</p>						
Gesamtbreite (cm)	Gesamttiefe (cm)	Gesamthöhe (cm)												
<b>94</b>	<b>60</b>	<b>47</b>												



Informationen:  
MAZUVO Referenz: Schloss Rued  
Photo de référence: Château de Rued



Abbildung / image	Artikel - Bezeichnung / description d'article	Preis Prix CHF																		
	<p><b>SPLIT Lounge Sessel mit Armlehne</b> Sperrholzsitz, Buche lackiert oder gebeizt nach Kollektion Sperrholzsitz, Esche lackiert oder gebeizt nach Kollektion</p> <p><b>SPLIT lounge fauteuil avec accoudoirs</b> Siège en contreplaqué, hêtre lacqué ou teinté selon collection Siège en contreplaqué, frêne laqué ou teinté selon collection</p> <table border="0"> <tr> <td data-bbox="801 523 992 550">Gesamtbreite (cm)</td> <td data-bbox="1189 523 1379 550">Gesamttiefe (cm)</td> <td data-bbox="1576 523 1767 550">Sitzbreite (cm)</td> </tr> <tr> <td data-bbox="801 555 925 582"><b>45,4 / 45,4</b></td> <td data-bbox="1189 555 1312 582"><b>50,4 / 46,3</b></td> <td data-bbox="1576 555 1700 582"><b>42,1 / 42,1</b></td> </tr> <tr> <td data-bbox="801 603 943 630">Sitztiefe (cm)</td> <td data-bbox="1189 603 1330 630">Gesamthöhe</td> <td data-bbox="1576 603 1718 630">Gesamthöhe</td> </tr> <tr> <td data-bbox="801 635 925 662"><b>39,2 / 39,2</b></td> <td data-bbox="1189 635 1339 662"><i>höherer Barhocker</i></td> <td data-bbox="1576 635 1762 662"><i>niedrigerer Barhocker</i></td> </tr> <tr> <td></td> <td data-bbox="1189 667 1240 694">(cm)</td> <td data-bbox="1576 667 1628 694">(cm)</td> </tr> <tr> <td></td> <td data-bbox="1189 699 1227 726"><b>98</b></td> <td data-bbox="1576 699 1608 726"><b>81</b></td> </tr> </table> <p>Gewicht / poids: 13.8 kg</p>	Gesamtbreite (cm)	Gesamttiefe (cm)	Sitzbreite (cm)	<b>45,4 / 45,4</b>	<b>50,4 / 46,3</b>	<b>42,1 / 42,1</b>	Sitztiefe (cm)	Gesamthöhe	Gesamthöhe	<b>39,2 / 39,2</b>	<i>höherer Barhocker</i>	<i>niedrigerer Barhocker</i>		(cm)	(cm)		<b>98</b>	<b>81</b>	<p>ab 2'079.- ab 2'189.-</p> <p>à partir de 2'079.- à partir de 2'189.-</p>
Gesamtbreite (cm)	Gesamttiefe (cm)	Sitzbreite (cm)																		
<b>45,4 / 45,4</b>	<b>50,4 / 46,3</b>	<b>42,1 / 42,1</b>																		
Sitztiefe (cm)	Gesamthöhe	Gesamthöhe																		
<b>39,2 / 39,2</b>	<i>höherer Barhocker</i>	<i>niedrigerer Barhocker</i>																		
	(cm)	(cm)																		
	<b>98</b>	<b>81</b>																		











Abbildung / image	Artikel - Bezeichnung / description d'article	Preis Prix CHF						
	<p><b>MERANO</b> Lounge Sessel mit Armlehne                      Buche lackiert oder gebeizt nach Kollektion                      Eiche lackiert, geölt oder gebeizt nach Kollektion                      Amerikanischer Nussbaum</p> <p><b>MERANO</b> lounge fauteuil avec accoudoirs                      Hêtre lacqué ou teinté selon collection                      Chêne laqué, huilée ou teinté selon collection                      Noyer américain</p> <table border="0"> <tr> <td>Gesamtbreite (cm) <b>49 / 49</b></td> <td>Gesamttiefe (cm) <b>47,9 / 47,9</b></td> <td>Sitzbreite (cm) <b>44 / 44</b></td> </tr> <tr> <td>Sitztiefe (cm) <b>36 / 36</b></td> <td>Gesamthöhe <i>höherer Barhocker</i> (cm) <b>99,4</b></td> <td>Gesamthöhe <i>niedrigerer Barhocker</i> (cm) <b>82,4</b></td> </tr> </table> <p>Gewicht / poids: 9.3 kg</p>	Gesamtbreite (cm) <b>49 / 49</b>	Gesamttiefe (cm) <b>47,9 / 47,9</b>	Sitzbreite (cm) <b>44 / 44</b>	Sitztiefe (cm) <b>36 / 36</b>	Gesamthöhe <i>höherer Barhocker</i> (cm) <b>99,4</b>	Gesamthöhe <i>niedrigerer Barhocker</i> (cm) <b>82,4</b>	<p>ab 1'159.-                      ab 1'539.-                      ab 2'199.-</p> <p>à partir de                      1'159.-                      1'539.-                      2'199.-</p>
Gesamtbreite (cm) <b>49 / 49</b>	Gesamttiefe (cm) <b>47,9 / 47,9</b>	Sitzbreite (cm) <b>44 / 44</b>						
Sitztiefe (cm) <b>36 / 36</b>	Gesamthöhe <i>höherer Barhocker</i> (cm) <b>99,4</b>	Gesamthöhe <i>niedrigerer Barhocker</i> (cm) <b>82,4</b>						



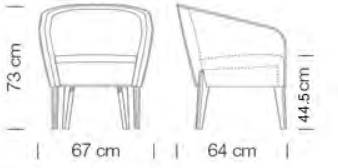

Abbildung / image	Artikel - Bezeichnung / description d'article	Preis Prix CHF
	<p><b>KYK Lounge Sessel mit Armlehne</b> Diverse Holz Ausführungen und Polsterungen möglich</p> <p><b>KYK Lounge fauteuil bas avec accoudoirs</b> Différents finitions du bois et tissus de rembourrage possibles</p> <div style="display: flex; align-items: center;"> <div style="margin-right: 20px;">  </div> <div> <ul style="list-style-type: none"> <li> Buche Ahorn gefärbt</li> <li> Buche Natur</li> <li> Buche wengé gefärbt</li> <li> Buche Schwarz gefärbt</li> <li> Buche Nussbaum Canaletto gefärbt</li> <li> Buche Eiche gefärbt</li> </ul> </div> </div> <p>Gewicht <b>13 kg</b></p>	<p>ab à partir de 1'399.-</p>



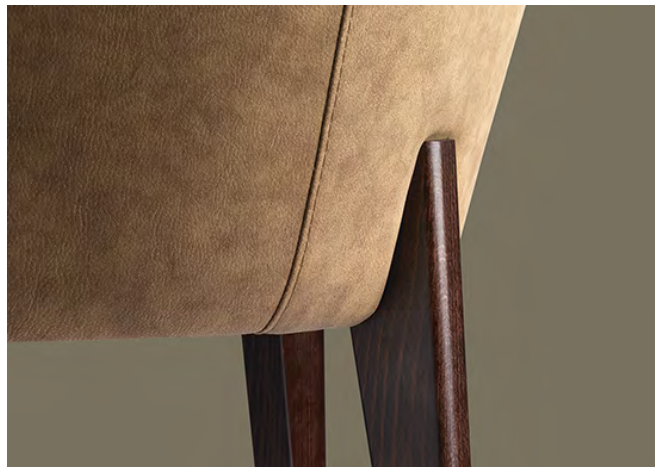



TON

Informationen:

Foto: Bauarena Volketswil

Konzeption und Planung: Hauser und Partner, Dübendorf

Mobiliar: TON/MAZUVO





Abbildung / image	Artikel - Bezeichnung / description d'article	Preis Prix CHF																		
	<p><b>MERANO</b> Barhocker Diverse Holzausführungen und Polsterungen möglich</p> <p><b>MERANO</b> Tabouret de bar Différents finitions du bois et divers tissus de rembourrage possible</p> <table border="0"> <tr> <td>Gesamtbreite (cm)</td> <td>Gesamttiefe (cm)</td> <td>Sitzbreite (cm)</td> </tr> <tr> <td><b>49 / 49</b></td> <td><b>47,9 / 47,9</b></td> <td><b>44 / 44</b></td> </tr> <tr> <td>Sitztiefe (cm)</td> <td>Gesamthöhe <i>höhere Barhocker</i></td> <td>Gesamthöhe <i>niedrigerer Barhocker</i></td> </tr> <tr> <td><b>36 / 36</b></td> <td>(cm) <b>99,4</b></td> <td>(cm) <b>82,4</b></td> </tr> </table>	Gesamtbreite (cm)	Gesamttiefe (cm)	Sitzbreite (cm)	<b>49 / 49</b>	<b>47,9 / 47,9</b>	<b>44 / 44</b>	Sitztiefe (cm)	Gesamthöhe <i>höhere Barhocker</i>	Gesamthöhe <i>niedrigerer Barhocker</i>	<b>36 / 36</b>	(cm) <b>99,4</b>	(cm) <b>82,4</b>	<p>ab à partir de 639.-</p>						
Gesamtbreite (cm)	Gesamttiefe (cm)	Sitzbreite (cm)																		
<b>49 / 49</b>	<b>47,9 / 47,9</b>	<b>44 / 44</b>																		
Sitztiefe (cm)	Gesamthöhe <i>höhere Barhocker</i>	Gesamthöhe <i>niedrigerer Barhocker</i>																		
<b>36 / 36</b>	(cm) <b>99,4</b>	(cm) <b>82,4</b>																		
	<p><b>LEAF</b> Barhocker Diverse Holzausführungen und Polsterungen möglich</p> <p><b>LEAF</b> Tabouret de bar Différents finitions du bois et divers tissus de rembourrage possible</p> <table border="0"> <tr> <td>Sitztiefe (cm)</td> <td>Gesamthöhe <i>höhere Barhocker</i></td> <td>Gesamthöhe <i>niedrigerer Barhocker</i></td> </tr> <tr> <td><b>39</b></td> <td>(cm) <b>103,5</b></td> <td>(cm) <b>88</b></td> </tr> <tr> <td>Gewicht des Produktes (kg)</td> <td>Volumen (m<sup>3</sup>)</td> <td>Carton dimensions (cm)</td> </tr> <tr> <td><b>5,6 / 5,3</b></td> <td><b>0,377 / 0,306</b></td> <td><b>56 x 54 x 108 / 54 x 53 x 93</b></td> </tr> <tr> <td>Sitzhöhe <i>höhere Barhocker</i></td> <td>Sitzhöhe <i>niedrigerer Barhocker</i></td> <td></td> </tr> <tr> <td>(cm) <b>76</b></td> <td>(cm) <b>61</b></td> <td></td> </tr> </table>	Sitztiefe (cm)	Gesamthöhe <i>höhere Barhocker</i>	Gesamthöhe <i>niedrigerer Barhocker</i>	<b>39</b>	(cm) <b>103,5</b>	(cm) <b>88</b>	Gewicht des Produktes (kg)	Volumen (m <sup>3</sup> )	Carton dimensions (cm)	<b>5,6 / 5,3</b>	<b>0,377 / 0,306</b>	<b>56 x 54 x 108 / 54 x 53 x 93</b>	Sitzhöhe <i>höhere Barhocker</i>	Sitzhöhe <i>niedrigerer Barhocker</i>		(cm) <b>76</b>	(cm) <b>61</b>		<p>ab à partir de 679.-</p>
Sitztiefe (cm)	Gesamthöhe <i>höhere Barhocker</i>	Gesamthöhe <i>niedrigerer Barhocker</i>																		
<b>39</b>	(cm) <b>103,5</b>	(cm) <b>88</b>																		
Gewicht des Produktes (kg)	Volumen (m <sup>3</sup> )	Carton dimensions (cm)																		
<b>5,6 / 5,3</b>	<b>0,377 / 0,306</b>	<b>56 x 54 x 108 / 54 x 53 x 93</b>																		
Sitzhöhe <i>höhere Barhocker</i>	Sitzhöhe <i>niedrigerer Barhocker</i>																			
(cm) <b>76</b>	(cm) <b>61</b>																			



Abbildung / image	Artikel - Bezeichnung / description d'article	Preis Prix CHF
 <p style="text-align: center;">Banana                      Ironica</p>	<p><b>BANANA</b> Barhocker / Tabouret de bar Buche, diverse Polsterungen möglich Structure en hêtre, divers tissus de rembourrage possible</p> <p><b>IRONICA</b> Barhocker / Tabouret de bar Buche, diverse Polsterungen möglich Structure en hêtre, divers tissus de rembourrage possiblee</p>	<p>ab à partir de 469.-</p> <p>ab à partir de 379.-</p>
 <p style="text-align: center;">Ideal                      Stockholm                      Punton</p>	<p><b>IDEAL</b> Barhocker / Tabouret de bar Buche, diverse Polsterungen möglich Structure en hêtre, divers tissus de rembourrage possible (Ausführung: nicht sichtbare Schrauben aus produktionstechnischen Gründen nicht möglich) (Version: vis non visibles impossible pour des raisons techniques de production)</p> <p><b>STOCKHOLM</b> Barhocker / Tabouret de bar Diverse Holz Ausführungen und Polsterungen möglich Différents finitions du bois et divers tissus de rembourrage possible</p> <p><b>PUNTON</b> Barhocker / Tabouret de bar Diverse Holz Ausführungen und Polsterungen möglich Différents finitions du bois et divers tissus de rembourrage possible</p>	<p>ab à partir de 379.-</p> <p>ab à partir de 449.-</p> <p>ab à partir de 499.-</p>





Abbildung / image	Artikel - Bezeichnung / description d'article	Preis Prix CHF												
	<p><b>VALENCIA</b> Barhocker Diverse Holzausführungen und Polsterungen möglich</p> <p><b>VALENCIA</b> Tabouret de bar Différents finitions du bois et divers tissus de rembourrage possible</p> <table border="0"> <tr> <td>Gesamtbreite (cm)</td> <td>Gesamttiefe (cm)</td> <td>Sitzbreite (cm)</td> </tr> <tr> <td><b>51</b></td> <td><b>52 / 52</b></td> <td><b>43</b></td> </tr> <tr> <td>Sitztiefe (cm)</td> <td>Gesamthöhe <i>höherer Barhocker</i></td> <td>Gesamthöhe <i>niedrigerer Barhocker</i></td> </tr> <tr> <td><b>45</b></td> <td>(cm) <b>116.5</b></td> <td>(cm) <b>97.5</b></td> </tr> </table>	Gesamtbreite (cm)	Gesamttiefe (cm)	Sitzbreite (cm)	<b>51</b>	<b>52 / 52</b>	<b>43</b>	Sitztiefe (cm)	Gesamthöhe <i>höherer Barhocker</i>	Gesamthöhe <i>niedrigerer Barhocker</i>	<b>45</b>	(cm) <b>116.5</b>	(cm) <b>97.5</b>	<p>ab à partir de 659.-</p>
Gesamtbreite (cm)	Gesamttiefe (cm)	Sitzbreite (cm)												
<b>51</b>	<b>52 / 52</b>	<b>43</b>												
Sitztiefe (cm)	Gesamthöhe <i>höherer Barhocker</i>	Gesamthöhe <i>niedrigerer Barhocker</i>												
<b>45</b>	(cm) <b>116.5</b>	(cm) <b>97.5</b>												
	<p><b>SPLIT</b> Barhocker Diverse Holzausführungen und Polsterungen möglich</p> <p><b>SPLIT</b> Tabouret de bar Différents finitions du bois et divers tissus de rembourrage possible</p> <table border="0"> <tr> <td>Gesamtbreite (cm)</td> <td>Gesamttiefe (cm)</td> <td>Sitzbreite (cm)</td> </tr> <tr> <td><b>45,4 / 45,4</b></td> <td><b>50,4 / 46,3</b></td> <td><b>42,1 / 42,1</b></td> </tr> <tr> <td>Sitztiefe (cm)</td> <td>Gesamthöhe <i>höherer Barhocker</i></td> <td>Gesamthöhe <i>niedrigerer Barhocker</i></td> </tr> <tr> <td><b>39,2 / 39,2</b></td> <td>(cm) <b>98</b></td> <td>(cm) <b>81</b></td> </tr> </table>	Gesamtbreite (cm)	Gesamttiefe (cm)	Sitzbreite (cm)	<b>45,4 / 45,4</b>	<b>50,4 / 46,3</b>	<b>42,1 / 42,1</b>	Sitztiefe (cm)	Gesamthöhe <i>höherer Barhocker</i>	Gesamthöhe <i>niedrigerer Barhocker</i>	<b>39,2 / 39,2</b>	(cm) <b>98</b>	(cm) <b>81</b>	<p>ab à partir de 1'299.-</p>
Gesamtbreite (cm)	Gesamttiefe (cm)	Sitzbreite (cm)												
<b>45,4 / 45,4</b>	<b>50,4 / 46,3</b>	<b>42,1 / 42,1</b>												
Sitztiefe (cm)	Gesamthöhe <i>höherer Barhocker</i>	Gesamthöhe <i>niedrigerer Barhocker</i>												
<b>39,2 / 39,2</b>	(cm) <b>98</b>	(cm) <b>81</b>												



Abbildung / image	Artikel – Bezeichnung / description d'article	Preis Prix CHF																								
	<p><b>811 Barhocker / Tabouret de bar</b>            Gestell Buche naturlackiert oder gebeizt nach Kollektion, Schilfrohrgeflecht            Sperrholzsitz gemäss Kollektion / Polsterung gemäss Kollektion</p> <p>Structure en hêtre naturel ou teinté selon collection, tresse de roseau            Contreplaqué selon collection            Rembourré selon collection</p> <table border="0"> <tr> <td>Gesamtbreite (cm)</td> <td>Gesamttiefe (cm)</td> <td>Sitzbreite (cm)</td> </tr> <tr> <td><b>48 / 46</b></td> <td><b>53 / 53</b></td> <td><b>45 / 45</b></td> </tr> <tr> <td>Sitztiefe (cm)</td> <td>Gesamthöhe <i>höhere Barhocker</i> (cm)</td> <td>Gesamthöhe <i>niedrigerer Barhocker</i> (cm)</td> </tr> <tr> <td><b>41 / 41</b></td> <td><b>109</b></td> <td><b>92</b></td> </tr> </table>	Gesamtbreite (cm)	Gesamttiefe (cm)	Sitzbreite (cm)	<b>48 / 46</b>	<b>53 / 53</b>	<b>45 / 45</b>	Sitztiefe (cm)	Gesamthöhe <i>höhere Barhocker</i> (cm)	Gesamthöhe <i>niedrigerer Barhocker</i> (cm)	<b>41 / 41</b>	<b>109</b>	<b>92</b>	<p>ab a partir de 699.-</p>												
Gesamtbreite (cm)	Gesamttiefe (cm)	Sitzbreite (cm)																								
<b>48 / 46</b>	<b>53 / 53</b>	<b>45 / 45</b>																								
Sitztiefe (cm)	Gesamthöhe <i>höhere Barhocker</i> (cm)	Gesamthöhe <i>niedrigerer Barhocker</i> (cm)																								
<b>41 / 41</b>	<b>109</b>	<b>92</b>																								
	<p><b>822 Barhocker / Tabouret de bar</b>            Erhältlich in Buche, lackiert, gebeizt nach Kollektion            Disponible en hêtre, lacqué, teinté selon collection</p> <p><b>Höhe/hauteur: 46cm</b></p> <table border="0"> <tr> <td>Gesamtbreite (cm)</td> <td>Gesamttiefe (cm)</td> <td>Gesamthöhe (cm)</td> </tr> <tr> <td><b>38.8</b></td> <td><b>38.8</b></td> <td><b>46</b></td> </tr> <tr> <td>Sitzhöhe (cm)</td> <td>Sitzbreite (cm)</td> <td>Sitztiefe (cm)</td> </tr> <tr> <td><b>46</b></td> <td><b>Durchmesser 37</b></td> <td><b>Durchmesser 37</b></td> </tr> </table> <p><b>Höhe/hauteur: 78cm</b></p> <table border="0"> <tr> <td>Gesamtbreite (cm)</td> <td>Gesamttiefe (cm)</td> <td>Sitzbreite (cm)</td> </tr> <tr> <td><b>46/42,6</b></td> <td><b>46/42,6</b></td> <td><b>ø 37</b></td> </tr> <tr> <td>Sitztiefe (cm)</td> <td>Gesamthöhe <i>höhere Barhocker</i> (cm)</td> <td>Gesamthöhe <i>niedrigerer Barhocker</i> (cm)</td> </tr> <tr> <td><b>ø 37</b></td> <td><b>78</b></td> <td><b>61</b></td> </tr> </table>	Gesamtbreite (cm)	Gesamttiefe (cm)	Gesamthöhe (cm)	<b>38.8</b>	<b>38.8</b>	<b>46</b>	Sitzhöhe (cm)	Sitzbreite (cm)	Sitztiefe (cm)	<b>46</b>	<b>Durchmesser 37</b>	<b>Durchmesser 37</b>	Gesamtbreite (cm)	Gesamttiefe (cm)	Sitzbreite (cm)	<b>46/42,6</b>	<b>46/42,6</b>	<b>ø 37</b>	Sitztiefe (cm)	Gesamthöhe <i>höhere Barhocker</i> (cm)	Gesamthöhe <i>niedrigerer Barhocker</i> (cm)	<b>ø 37</b>	<b>78</b>	<b>61</b>	<p>319.-</p> <p>429.-</p>
Gesamtbreite (cm)	Gesamttiefe (cm)	Gesamthöhe (cm)																								
<b>38.8</b>	<b>38.8</b>	<b>46</b>																								
Sitzhöhe (cm)	Sitzbreite (cm)	Sitztiefe (cm)																								
<b>46</b>	<b>Durchmesser 37</b>	<b>Durchmesser 37</b>																								
Gesamtbreite (cm)	Gesamttiefe (cm)	Sitzbreite (cm)																								
<b>46/42,6</b>	<b>46/42,6</b>	<b>ø 37</b>																								
Sitztiefe (cm)	Gesamthöhe <i>höhere Barhocker</i> (cm)	Gesamthöhe <i>niedrigerer Barhocker</i> (cm)																								
<b>ø 37</b>	<b>78</b>	<b>61</b>																								



Abbildung / image	Artikel – Bezeichnung / description d'article	Preis Prix CHF
	<p><b>BRERA 387</b>                      Barhocker aus Eiche / Tabouret de bar en chene                      Diverse Farben möglich / Diverse couleurs possible</p>  <p>Gewicht / poids: 4.0 kg                      Verpackungseinheit / unité à: 1                      Mindestbestellmenge: 1 Stk. / quantité minimale: 1 pcs.</p>	<p>ab                      a partir de                      369.-</p>
	<p><b>BRERA 382</b>                      Barhocker aus Eiche / Tabouret de bar en chene                      Diverse Farben möglich / Diverse couleurs possible</p>  <p>Gewicht / poids: 5.2 kg                      Verpackungseinheit / unité à: 1                      Mindestbestellmenge: 1 Stk. / quantité minimale: 1 pcs.</p>	<p>ab                      à partir de                      449.-</p>





Abbildung / image	Artikel – Bezeichnung / description d'article	Preis Prix CHF
 <p>Stapelmenge / quantité d'empilement: 4 Gewicht / poids: 6.2 kg Verpackungseinheit / unité à: 2</p>	<p><b>KUADRA 1326</b> Barhocker, Schale aus Sperrholz Eiche gebleicht, Gestell aus viereckigem Stahlrohr 20x20mm verchromt oder satiniert Tabouret bar avec coque en multiplis plaqué en chêne blanchi, teinté. Piètement en tube 20x20mm en acier satiné ou chromé</p> <p>Auch in 65cm Sitzhöhe erhältlich, disponible aussi en hauteur siege de 65cm</p> <p><b>Farben Sitzschale / couleurs siège:</b></p>  <p>Eiche gebl.    Wenige    schwarz chêne blan.    Wengé    noir</p> <p>Mindestbestellmenge : 2 Stk. / quantité minimale : 2 pcs.</p>	<p>Ab à partir de 299.-</p>
 <p>Stapelmenge / quantité d'empilement: 4 Gewicht / poids: 6.5 kg Verpackungseinheit / unité à: 2</p>	<p><b>KUADRA 1336</b> Barhocker, Sitzschale aus Sperrholz, gebleichte Eiche. Rundrohrgestell aus Edelstahl verchromt oder matt verchromt Durchmesser 16mm. Stapelbar Tabouret avec coque en multiplis plaqué en chêne blanchi. Piètement en tube d'acier chromé diamètre 16mm. Empilable.</p> <p>Auch in 65cm Sitzhöhe erhältlich, disponible aussi en hauteur siege de 65cm</p> <p><b>Farben Sitzschale / couleurs siège:</b></p>  <p>Eiche gebl.    Wenige    schwarz chêne blan.    Wengé    noir</p> <p>Mindestbestellmenge: 2 Stk. / quantité minimale: 2 pcs.</p>	<p>Ab à partir de 249.-</p>















Abbildung / image	Artikel – Bezeichnung / description d'article	Preis Prix CHF
	<p><b>KICCA 336</b> Barhocker mit 4-beinigem Stahlgestell Sitzfläche und Rückenlehne gepolstert mit Stoff</p> <p><b>Tabouret de bar</b> Structure à 4 pieds en tube d'acier Assise et dossier rembourrés</p> <p>Gewicht / poids: 12.1 kg Verpackungseinheit / unité à: 1 Mindestbestellmenge: 1 Stk. / quantité minimale: 1 pcs.</p>	<p>ab à partir de 699.-</p>
	<p><b>ARKI ARKW6</b> Barhocker, tabouret de bar Gestell: Holz, drehbar, höhenverstellbar Structure: bois, pivotant, réglable en hauteur</p> <p><b>Höhe/Hauteur: 65 – 75cm</b></p> <p><b>FINISHES / Finiture</b></p> <p>  RS AN</p> <p> MC 0,145 </p> <p></p> <p></p> <p>Mindestbestellmenge: 1 Stk. / quantité minimale: 1 pcs.</p>	<p>429.-</p>

Abbildung / image	Artikel – Bezeichnung / description d'article	Preis Prix CHF
	<p><b>NOMAD 822</b> Bank mit Armlehne Diverse Holz Ausführungen und Polsterungen möglich</p> <p><b>NOMAD 822</b> divan avec accoudoirs Différents finitions du bois et tissus divers de rembourrage possible</p>	<p>ab à partir de 1'699.-</p>
	<p><b>NOMAD 824</b> Bank mit Armlehne Diverse Holz Ausführungen und Polsterungen möglich</p> <p><b>NOMAD 824</b> divan avec accoudoirs Différents finitions du bois et tissus divers de rembourrage possible</p>	<p>ab à partir de 1'999.-</p>

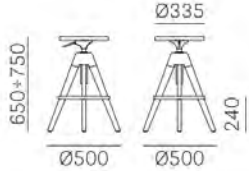
Gestellfarben:





Abbildung / image	Artikel – Bezeichnung / description d'article	Preis Prix CHF
	<p><b>KYK Bank mit Armlehne</b> Diverse Holz Ausführungen und Polsterungen möglich</p> <p><b>KYK divan avec accoudoirs</b> Différents finitions du bois et tissus divers de rembourrage possible</p> 	<p>ab à partir de 1'599.-</p>



# PEDRALI®





Abbildung / image	Artikel – Bezeichnung / description d'article	Preis / Prix CHF
	<p><b>SOCIAL PLUS 2er Element</b> (Modulares System)          Polsterung nach Kollektion          Polyurethanschaum mit elastischen Gurten in der Rückenlehne, Stahlrahmen und Beinen aus Aluminiumdruckguss</p> <p><b>SOCIAL PLUS 2er Element</b> (système modulaire)          Contreplaqué selon collection          Intérieur : en mousse de polyuréthane avec sangles élastiques dans le dossier, d'une structure en acier et de pieds en aluminium moulé sous pression aux extrémités</p>	<p>ab          à partir de          2'099.-</p>
	<p><b>SOCIAL PLUS 2er Element mit Seitenlehne</b> (Modulares System)          Polsterung nach Kollektion          Polyurethanschaum mit elastischen Gurten in der Rückenlehne, Stahlrahmen und Beinen aus Aluminiumdruckguss</p> <p><b>SOCIAL PLUS 2er Element avec appui latéral</b> (système modulaire)          Contreplaqué selon collection          Intérieur : en mousse de polyuréthane avec sangles élastiques dans le dossier, d'une structure en acier et de pieds en aluminium moulé sous pression aux extrémités</p>	<p>ab          à partir de          2'299.-</p>
	<p><b>SOCIAL PLUS 3er Sofa</b> (Modulares System)          Polsterung nach Kollektion          Polyurethanschaum mit elastischen Gurten in der Rückenlehne, Stahlrahmen und Beinen aus Aluminiumdruckguss</p> <p><b>SOCIAL PLUS 3er Sofa</b> (système modulaire)          Contreplaqué selon collection          Intérieur : en mousse de polyuréthane avec sangles élastiques dans le dossier, d'une structure en acier et de pieds en aluminium moulé sous pression aux extrémités</p>	<p>ab          à partir de          2'999.-</p>

# PEDRALI®







Abbildung / image	Artikel – Bezeichnung / description d'article	Preis / Prix CHF
	<p><b>BUDDY</b> Pouf 210/211/212/213/214/215          Polsterung nach Kollektion          Innenleben: aus gepolstertem Polyurethanschaum, Gestell (Beine) aus Aluminium          Diverse Grössen erhältlich</p> <p><b>BUDDY</b> Pouf 210/211/212/213/214/215          Contreplaqué selon collection          Assise rembourrée en mousse de polyuréthane et pieds en aluminium          Différentes tailles disponibles</p>	<p>ab  à partir de  579.-</p>
	<p><b>BUDDY</b> Sessel 210S/211S/212S/213S/ 214S/215S          Polsterung nach Kollektion          Innenleben: aus gepolstertem Polyurethanschaum, Gestell (Beine) aus Aluminium          Diverse Grössen erhältlich</p> <p><b>BUDDY</b> fauteuil 210S/211S/212S/213S/ 214S/215S          Contreplaqué selon collection          Assise rembourrée en mousse de polyuréthane et pieds en aluminium          Différentes tailles disponibles</p>	<p>ab  à partir de  1'059.-</p>

**PEDRALI**®



Informationen:  
photo by Ottavio Tomasini

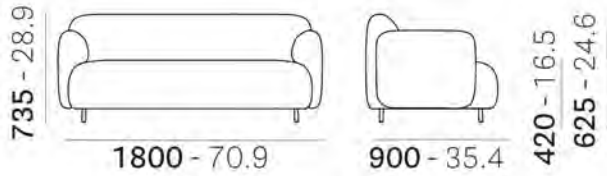

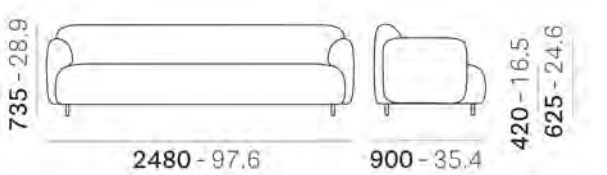
Abbildung / image	Artikel – Bezeichnung / description d'article	Preis / Prix CHF
	<p><b>BUDDY 2er Sofa 218</b>                      Polsterung nach Kollektion                      Innenleben: aus gepolstertem Polyurethanschaum, Gestell (Beine) aus Aluminium</p> <p><b>BUDDY 2er Sofa 218</b>                      Contreplaqué selon collection                      Assise rembourrée en mousse de polyuréthane et pieds en aluminium</p> 	<p>ab                      à partir de                      3'899.-</p>
	<p><b>BUDDY 3er Sofa 219</b>                      Polsterung nach Kollektion                      Innenleben: aus gepolstertem Polyurethanschaum, Gestell (Beine) aus Aluminium</p> <p><b>BUDDY 3er Sofa 219</b>                      Contreplaqué selon collection                      Assise rembourrée en mousse de polyuréthane et pieds en aluminium</p> 	<p>ab                      à partir de                      4'489.-</p>

**PEDRALI**®







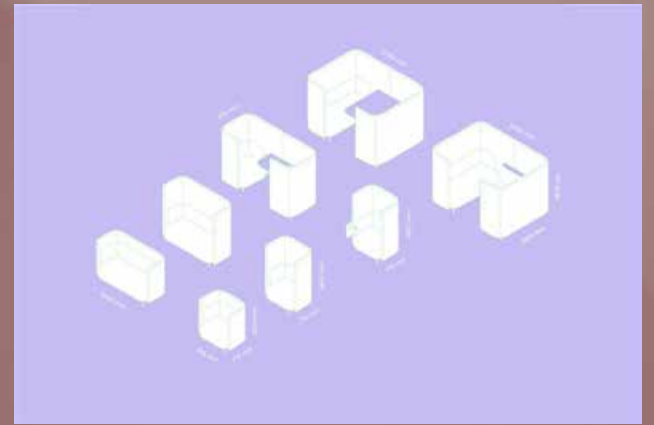

Abbildung / image	Artikel – Bezeichnung / description d'article	Preis / Prix CHF
 <p data-bbox="271 549 398 571">BDH001/100</p> <p data-bbox="544 549 672 571">BDH001/140</p>	<p data-bbox="804 204 1075 226"><b>BUDDYHUB 1<sup>er</sup> Modul</b></p> <p data-bbox="804 240 1727 341">Polsterung nach Kollektion Innenleben: aus gepolstertem Polyurethanschaum, Gestell (Beine) aus Aluminium Umlaufendes Schallschutzpaneel in zwei Höhen</p> <p data-bbox="804 416 1075 438"><b>BUDDYHUB 1<sup>er</sup> Modul</b></p> <p data-bbox="804 453 1626 553">Contreplaqué selon collection Assise rembourrée en mousse de polyuréthane et pieds en aluminium Caractérisé par un panneau insonorisant périphérique en deux hauteurs</p>	<p data-bbox="1962 209 2085 304">ab à partir de 4'499.-</p>
 <p data-bbox="277 900 405 922">BDH001/100</p> <p data-bbox="535 900 663 922">BDH001/140</p>	<p data-bbox="804 644 1075 667"><b>BUDDYHUB 2<sup>er</sup> Modul</b></p> <p data-bbox="804 681 1727 782">Polsterung nach Kollektion Innenleben: aus gepolstertem Polyurethanschaum, Gestell (Beine) aus Aluminium Umlaufendes Schallschutzpaneel in zwei Höhen</p> <p data-bbox="804 857 1075 879"><b>BUDDYHUB 2<sup>er</sup> Modul</b></p> <p data-bbox="804 893 1626 994">Contreplaqué selon collection Assise rembourrée en mousse de polyuréthane et pieds en aluminium Caractérisé par un panneau insonorisant périphérique en deux hauteurs</p>	<p data-bbox="1962 647 2085 743">ab à partir de 5'799.-</p>
 <p data-bbox="405 1319 539 1342">BDH002/140</p>	<p data-bbox="804 1064 1075 1086"><b>BUDDYHUB PRIVACY</b></p> <p data-bbox="804 1101 1727 1201">Polsterung nach Kollektion Innenleben: aus gepolstertem Polyurethanschaum, Gestell (Beine) aus Aluminium Umlaufendes Schallschutzpaneel</p> <p data-bbox="804 1238 1075 1260"><b>BUDDYHUB PRIVACY</b></p> <p data-bbox="804 1275 1603 1375">Contreplaqué selon collection Assise rembourrée en mousse de polyuréthane et pieds en aluminium Caractérisé par un panneau insonorisant périphérique</p>	<p data-bbox="1962 1067 2085 1163">ab à partir de 9'989.-</p>

**PEDRALI**®







ab / à partir de: CHF 8'549.-



ab / à partir de: CHF 7'089.-



ab / à partir de: CHF 3'549.-



ab / à partir de: CHF 2'869.-



ab / à partir de: CHF 2'169.-



TON



**Informationen:**

Foto: Bauarena Volketswil

Konzeption und Planung: Hauser und Partner, Dübendorf

Mobiliar: TON/MAZUVO

Modern, gemütlich, flexibel. Das modulare System der Bänke, das mit seinem puren Design sowohl in Haushalte als auch in öffentliche Räume passt. Die Holzkonstruktion bildet minimalistische Konturen und die Polsterung schafft Komfort. Diner gibt es in drei verschiedenen Höhen und zwei Eckvarianten. Beratung und Preise auf Anfrage !

Moderne, confortable, flexible. Le système modulaire de bancs qui, grâce à sa conception pure, s'intègre aussi bien dans les foyers que dans les espaces publics. La construction en bois forme des contours minimalistes et le rembourrage crée du confort. Les dîners sont disponibles en trois hauteurs différentes et en deux versions d'angle. Conseils et prix sur demande !



Beispiel / ab: CHF 4'789.-  
Set prix à partir de: CHF 4'789.-





Abbildung / image	Artikel – Bezeichnung / description d'article	Preis Prix CHF
	<p><b>Tischplatte</b>  <b>Grösse nach Wunsch</b>                  Kern Leichtbau Pappel 25mm aus Kollektion Argolite                  Kanten 2mm ABS anthrazit, oben und unten Radius 2mm</p> <p><b>Plateau de table</b>  <b>Dimension en choix</b>                  Surface panneau léger en peuplier de la collection Argolite                  Bords 2mm ABS anthracite, rayon supérieur et inférieur 2mm</p> <p><b>Untergestell</b> (Art. 110 – 1 Paar)                  Material: Rundrohr Gestell aus Stahl                  Verstellgleiter oder feste Winkelgleiter</p> <p><b>Piètement</b> (Art. 110 – 1 paire)                  Material : cadre en tube rond en acier                  Patins réglables ou patins fixe</p> <p><b>Weitere Modelle auf Anfrage / autres modèles sur demande :</b></p> 	<p>auf Anfrage</p> <p>sur demande</p> <p>ab 349.-</p> <p>à partir de 349.-</p>









Abbildung / image	Artikel – Bezeichnung / description d'article	Preis Prix CHF
	<p><b>Timmy LIBRO, Konferenz Tisch, Table de conférence</b>                      Diverse Grössen. Weitere Informationen über Gestell, Platten und Zubehör auf Seite 91                      Différentes tailles. Pour plus d'informations sur le piètement, les plateaux et les accessoires, voir page 91</p> 	auf Anfrage sur demande
	<p><b>TIMMY R, 215R, Konferenz Tisch, Table de conférence</b>                      Diverse Grössen. Weitere Informationen über Gestell, Platten und Zubehör auf Seite 91                      Différentes tailles. Pour plus d'informations sur le piètement, les plateaux et les accessoires, voir page 91</p> 	auf Anfrage sur demande
	<p><b>TIMMY P, 215P, Konferenz Tisch, Table de conférence</b>                      Diverse Grössen. Weitere Informationen über Gestell, Platten und Zubehör auf Seite 91                      Différentes tailles. Pour plus d'informations sur le piètement, les plateaux et les accessoires, voir page 91</p> 	auf Anfrage sur demande

Abbildung / image	Artikel – Bezeichnung / description d'article	Preis Prix CHF
	<p><b>TIMMY F, 215F, Konferenz Tisch, Table de conférence</b>                      Diverse Grössen. Weitere Informationen über Gestell, Platten und Zubehör auf Seite 91                      Différentes tailles. Pour plus d'informations sur le piètement, les plateaux et les accessoires, voir page 91</p> 	<p>auf Anfrage sur demande</p>
	<p><b>ECO 216 R, Konferenz Tisch, Table de conférence</b>                      Diverse Grössen. Weitere Informationen über Gestell, Platten und Zubehör auf Seite 91                      Différentes tailles. Pour plus d'informations sur le piètement, les plateaux et les accessoires, voir page 91</p> 	<p>auf Anfrage sur demande</p>

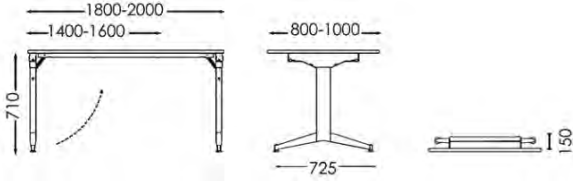

**FRAME / STRUTTURA**

**Powder coated steel, Chromed**  
 Acciaio verniciato, Cromato



**100 smooth**  
 liscio  
 RAL 9006



**132 smooth**  
 liscio



**116 smooth semi-glossy**  
 liscio semilucido  
 RAL 9005



**chromed**  
 cromato



**296 textured**  
 raggrinzato  
 RAL 9010



**235 textured**  
 raggrinzato  
 RAL 7035



**131 textured**  
 raggrinzato  
 RAL 9006



**148 textured**  
 raggrinzato  
 RAL 7016



**120 textured**  
 raggrinzato  
 RAL 9005



Kabeldurchführung



Kabelmanagement mit Steckdosen



Multifunktionssteckdose



Multifunktionssteckdose



Elektrifizierkit



Sichtblende



Kit für die Verbindung der Platten



Kit für die Verbindung der Platten aus Metall

**TOP / PIANO**

**Standard laminate and melamine top**  
 Piani standard laminato e nobilitato

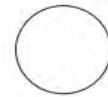

**white**  
 bianco



**magnolia**



**light grey**  
 grigio  
 chiaro



**anthracite**  
 antracite



**black**  
 nero



**whitened oak**  
 rovere  
 sbiancato



**natural oak**  
 rovere  
 naturale



**grey olm**  
 olmo  
 grigio



**painted olm**  
 olmo tinto



**wengé**



Abbildung / image	Artikel – Bezeichnung / description d'article	Preis Prix CHF
 <p style="text-align: center;">T1                      T2</p>	<p><b>Stapelkarren / chariot: Modell T1</b> Robuste, kompakte Stahlkonstruktion verzinkt Construction robuste et compact en acier galvanisé</p> <p><b>Stapelkarren / chariot: Modell T2</b> Robuste, kompakte Stahlkonstruktion verzinkt Construction robuste et compact en acier galvanisé</p>	<p style="text-align: center;">239.-</p> <p style="text-align: center;">489.-</p>
	<p><b>Transportwagen TT6</b> Plattform nach Grösse der Tischplatte 1 Längs- und Stossbügel fest verschweisst Zweiter Längsbügel steckbar Einlegeplatte mit Teppich belegt Tragkraft 1000 KG Pulverbeschichtet RAL 9007 ME 521</p> <p><b>Chariot TT6</b> Plate-forme selon la dimension du plateau de table 1 barre longitudinale et antichoc soudée Deuxième levier unique peut être branché Insérer une plaque recouverte de tapis Capacité 1000 KG thermolaqué RAL 9007 ME 521</p>	<p style="text-align: center;">ab à partir de 1'099.-</p>









Abbildung / image	Artikel – Bezeichnung / description d'article	Preis Prix CHF
	<p><b>BLOOM 271 Tisch</b>            Verschiedene Farben von Tischplatten (28mm) und Bodenplatten möglich.            Différents couleurs de plateaux de table (28mm) et de plateaux de base possibles.</p> <p>Grösse / dimension: 70x70cm, 80x80cm            Höhe / hauteur: 75cm</p>	<p>ab            à partir de            1'599.-</p>
	<p><b>BLOOM 272 Tisch</b>            Verschiedene Farben von Tischplatten (28mm) und Bodenplatten möglich.            Différents couleurs de plateaux de table (28mm) et de plateaux de base possibles.</p> <p>Grösse / dimension: Ø 80 cm, Ø 90cm            Höhe / hauteur: 75cm</p>	<p>ab            à partir de            1'489.-</p>
	<p><b>BLOOM 277 Tisch</b>            Verschiedene Farben von Tischplatten (28mm) und Bodenplatten möglich.            Différents couleurs de plateaux de table (28mm) et de plateaux de base possibles.</p> <p>Grösse / dimension: Ø 80cm, Ø 90cm            Höhe / hauteur: 30cm</p>	<p>ab            à partir de            1'499.-</p>
	<p><b>BLOOM 278 Tisch</b>            Verschiedene Farben von Tischplatten (28mm) und Bodenplatten möglich.            Différents couleurs de plateaux de table (28mm) et de plateaux de base possibles.</p> <p>Grösse / dimension: 60x60cm, 70x70cm            Höhe / hauteur: 105cm</p>	<p>ab            à partir de            1'439.-</p>





Abbildung / image	Artikel - Bezeichnung / description d'article	Preis Prix CHF
	<p><b>DELTA 724 Tisch / Table</b>            Buche oder Eiche Massiv            Hêtre ou chêne massif</p> <p>Grösse / Dimension: 80cm            Höhe / Hauteur: 35cm</p>	<p>ab            à partir de            949.-</p>
	<p><b>DELTA 723 Tisch / Table</b>            Buche oder Eiche Massiv            Hêtre ou chêne massif            Grösse / Dimension: 60cm - Höhe / Hauteur: 45cm</p> <p><b>DELTA 722 Tisch / Table</b>            Buche oder Eiche Massiv            Hêtre ou chêne massif            Grösse / Dimension: 40cm - Höhe / Hauteur: 60cm</p>	<p>ab            à partir de            799.-</p> <p>ab            à partir de            629.-</p>
	<p><b>MALMÖ Tisch / Table</b>            Buche oder Eiche Massiv            Hêtre ou chêne massif            Grösse / Dimension: Ø 120cm            Höhe / Hauteur: 76cm</p>	<p>ab            à partir de            1'999.-</p>
	<p><b>MALMÖ Tisch / Table</b>            Buche oder Eiche Massiv            Hêtre ou chêne massif            Grösse / Dimension: 90 x 90 / 140 x 90 / 170 x 90 / 200 x 90cm            Höhe / Hauteur: 76cm</p>	<p>ab            à partir de            1'499.-</p>





Abbildung / image	Artikel - Bezeichnung / description d'article	Preis Prix CHF
	<p><b>IRONICA Tisch / Table</b>                      Buche / Hêtre, Multitplex Platte oder MDF Platte                      Höhe / Hauteur: 76cm</p> <p><b>Masse / Dimension:</b>                      80x80cm (Modell 134)                      120x80cm (Modell 135)</p>	<p>ab à partir de</p> <p>879.- 1'149.-</p>
	<p><b>Lasu Tisch / Table</b>                      Buche oder Eiche Massiv, Furnierplatte                      Hêtre ou chêne massif, furnier                      Höhe / Hauteur: 76cm</p> <p><b>Masse / Dimension:</b>                      90 x 90 / 139 x 90 / 160 x 90cm</p>	<p>ab à partir de</p> <p>1'589.-</p>
	<p><b>Stockholm Tisch / Table</b>                      Buche oder Eiche Massiv, Furnier oder Massivplatte                      Hêtre ou chêne massif, furnier                      Höhe / Hauteur: 76cm</p> <p><b>Masse / Dimension:</b>                      90 x 90 / 120 x 80 / 160 x 90 / 200 x 90cm</p>	<p>ab à partir de</p> <p>1'349.-</p>
	<p><b>INK 44 Tisch / Table</b>                      Buche oder Eiche Massiv, Massivplatte                      Hêtre ou chêne massif                      Höhe / Hauteur: 76cm</p> <p><b>Masse / Dimension:</b>                      160 x 90 / 200 x 100cm</p>	<p>ab à partir de</p> <p>3'289.-</p>







Abbildung / image	Artikel - Bezeichnung / description d'article	Preis Prix CHF
	<p><b>P.O.V 460 / 461 / 462 Tische / Table</b>            Buche, Eiche oder Nussbaum / hêtre, chêne ou noyer            Höhe / Hauteur: 75cm</p> <p><b>Masse / Dimension:</b>            60x60, 70x70, 80x80, 90x90, 100x100, 110x100, 120x120, 130x130, 140x140, 150x150cm            60, 70, 80, 90, 120, 130, 140, 150cm rund</p>	<p>ab à partir de</p> <p>1'499.-</p>
	<p><b>P.O.V 463 Hochtische / Table haute</b>            Buche, Eiche oder Nussbaum / hêtre, chêne ou noyer            Höhe / Hauteur: 104cm</p> <p><b>Masse / Dimension:</b>            70x70, 80x80, 90x90, 100x100cm            70, 80, 90, 100cm rund</p>	<p>ab à partir de</p> <p>1'779.-</p>
	<p><b>P.O.V 464 /Tisch / Table</b>            Buche, Eiche oder Nussbaum / hêtre, chêne ou noyer, Höhe / Hauteur: 75cm</p> <p><b>Masse / Dimension:</b>            120x240cm</p> <p><b>P.O.V 470 Tische / Table</b>            Buche, Eiche oder Nussbaum / hêtre, chêne ou noyer, Höhe / Hauteur: 75cm</p> <p><b>Masse / Dimension:</b>            80x180, 90x180, 90x200, 100x200, 100x220</p>	<p>ab à partir de</p> <p>4'499.-</p>

Abbildung / image	Artikel - Bezeichnung / description d'article	Preis Prix CHF
	<p><b>P.O.V 465 / 466 / 467 Tische / Table</b>            Buche, Eiche oder Nussbaum / hêtre, chêne ou noyer            Höhe / Hauteur: 75cm</p> <p><b>Masse / Dimension:</b>            110x220, 120x240, 130x260, 140x280, 150x300cm</p>	<p>ab            à partir de            4'449.-</p>
	<p><b>P.O.V 463 Hochtische / Table haute</b>            Buche, Eiche oder Nussbaum / hêtre, chêne ou noyer            Höhe / Hauteur: 107cm</p> <p><b>Masse / Dimension:</b>            80x200, 90x220, 100x240cm</p>	<p>ab            à partir de            4'279.-</p>



# PEDRALI®



Tischuntergestelle  
Pièment de table









Abbildung / image	Artikel - Bezeichnung / description d'article	Preis Prix CHF
 <p data-bbox="405 675 772 703">Version Antik (Messing oder Kupfer)</p> <p data-bbox="405 727 743 756">Version antique (laiton ou cuivre)</p>	<p data-bbox="913 247 1111 276"><b>INOX 4402 REG</b></p> <p data-bbox="913 284 1491 349"><b>Tischgestell</b>, Sockel und Säule aus Edelstahl matt mit Verstellgleitern.</p> <p data-bbox="913 394 1375 459"><b>Pied</b>, en acier inox brossé avec colonne avec vérins réglables.</p> <p data-bbox="913 502 1283 531"><b>Version Antik / Version antique</b></p> <p data-bbox="947 564 1151 593"><b>PACKING / Imballo</b></p> <div data-bbox="947 628 1361 754">  <p data-bbox="947 703 1055 732">0,035 MC</p> <p data-bbox="1106 703 1189 732">40 pcs</p> <p data-bbox="1234 703 1279 754">16* kg</p> <p data-bbox="1308 703 1352 754">17,5 kg</p> </div> <p data-bbox="1496 564 1912 593"><b>TECHNICAL DETAILS / Dettagli tecnici</b></p> <div data-bbox="1496 600 1928 754">  <p data-bbox="1832 600 1928 628">TOP MAX</p> <p data-bbox="1503 727 1592 754">400x400</p> <p data-bbox="1608 660 1637 711">730</p> <p data-bbox="1704 660 1771 689">50x50</p> <p data-bbox="1832 727 1928 754">900x900</p> </div>	<p data-bbox="2018 276 2136 376">ab à partir de 229.-</p> <p data-bbox="2018 485 2136 585">ab à partir de 339.-</p>
	<p data-bbox="913 863 1160 892"><b>INOX 4402_RV REG</b></p> <p data-bbox="913 900 1951 1000"><b>Tischgestell</b> mit Eichensäule furniert, Eiche gebleicht oder wenge gebeizt. Edelstahlsockel. Verfügbar auch mit rechteckigem Sockel 750x400 mm (Artikel 4462/RV) und Variante mit runder Eichensäule Ø76 mm und Sockel Ø450 mm (Artikel 4411/RV). Mit Verstellgleitern.</p> <p data-bbox="913 1045 1845 1074"><b>Pied</b>, avec colonne plaqué en chêne blanchi ou teinté wengé. Base en acier inox.</p> <p data-bbox="913 1082 1966 1147">Disponibile aussi avec base rectangulaire 750x400 mm (4462/RV) et la version avec colonne ronde Ø76 mm et base Ø450 mm (4411/RV). Avec vérins réglables</p> <p data-bbox="947 1181 1151 1209"><b>PACKING / Imballo</b></p> <div data-bbox="947 1244 1361 1370">  <p data-bbox="947 1319 1055 1348">0,035 MC</p> <p data-bbox="1106 1319 1189 1348">40 pcs</p> <p data-bbox="1234 1319 1279 1370">16* kg</p> <p data-bbox="1308 1319 1352 1370">17,5 kg</p> </div> <p data-bbox="1496 1181 1912 1209"><b>TECHNICAL DETAILS / Dettagli tecnici</b></p> <div data-bbox="1496 1216 1928 1370">  <p data-bbox="1832 1216 1928 1244">TOP MAX</p> <p data-bbox="1503 1342 1592 1369">400x400</p> <p data-bbox="1608 1275 1637 1326">730</p> <p data-bbox="1704 1278 1771 1307">50x50</p> <p data-bbox="1832 1342 1928 1369">900x900</p> </div>	<p data-bbox="2018 927 2136 1027">ab à partir de 289.-</p>





Abbildung / image	Artikel - Bezeichnung / description d'article	Preis Prix CHF
	<p><b>INOX 4421</b>  <b>Tischgestell</b>, Sockel aus Edelstahl matt oder glanz mit Edelstahladapter, auch in Outdoor-tauglichen Qualität erhältlich! Mit Verstellgleitern.</p> <p><b>Pied</b>, avec base et bague en acier inox brossé. Disponible aussi en qualité extérieur. Avec vérins réglables.</p> <p><b>PACKING / Imballo</b></p>  <p>0,043 MC    32 pcs    16* kg    17,5 kg</p> <p><b>TECHNICAL DETAILS / Dettagli tecnici</b></p>  <p>400x400    730    Ø76    TOP MAX    900x900</p>	<p>ab à partir de 239.-</p>
	<p><b>INOX 4406</b>  <b>Stehstischgestell</b>, Barhöhe mit Säule und Sockel aus Stahlrohr pulverbeschichtet.</p> <p><b>Pied haut</b>, colonne en tube d'acier thermolaqué en différents couleurs.</p> <p><b>PACKING / Imballo</b></p>  <p>0,031 MC    36 pcs    16,5* kg    18,5 kg</p> <p><b>TECHNICAL DETAILS / Dettagli tecnici</b></p>  <p>400x400    1100    50x50    TOP MAX    700x700</p>	<p>ab à partir de 229.-</p>



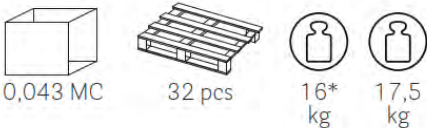

Abbildung / image	Artikel - Bezeichnung / description d'article	Preis Prix CHF
	<p><b>INOX 4461 REG</b>  <b>Tischgestell</b>, Sockel und Doppelsäule RUND aus Edelstahl matt mit Verstellgleitern.</p> <p><b>Pied</b>, base et double colonne en acier ROND inox mat avec vérins réglables.</p> <p><b>PACKING / Imballo</b></p>  <p>0,051 MC    24 pcs    32 kg</p> <p><b>TECHNICAL DETAILS / Dettagli tecnici</b></p>  <p>750x400    730    2x Ø76</p> <p><b>TOP MAX</b></p>  <p>1600x900</p>	<p>ab à partir de 339.-</p>
	<p><b>INOX 4467 REG</b>  <b>Tischgestell</b>, Sockel und Doppelsäule ECKIG aus Edelstahl matt mit Verstellgleitern.</p> <p><b>Pied</b>, base et double colonne en acier carré inox mat avec vérins réglables.</p> <p><b>PACKING / Imballo</b></p>  <p>0,051 MC    24 pcs    27,5* kg    30 kg</p> <p><b>TECHNICAL DETAILS / Dettagli tecnici</b></p>  <p>750x400    500    2x 50x50</p> <p><b>TOP MAX</b></p>  <p>1600x900</p>	<p>ab à partir de 359.-</p>



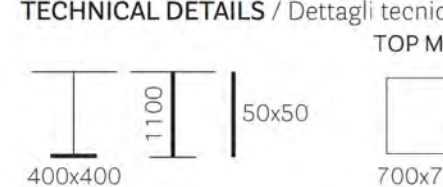



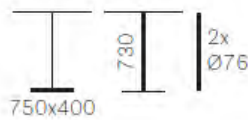
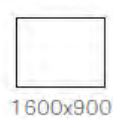

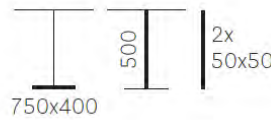
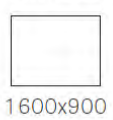
Abbildung / image	Artikel - Bezeichnung / description d'article	Preis Prix CHF
	<p><b>TONDA 4150 REG</b>  <b>Tischgestell</b>, Sockel aus sandgestrahltem Gusseisen und Edelstahlsäule, pulverbeschichtet in verschiedenen Farben.</p> <p><b>Pied</b>, base en fonte sablé et colonne, en tube d'acier thermolaqué dans différents coloris. Colonne chromée ou en acier inox brossé sur demande.</p> <p><b>PACKING / Imballo</b></p>  <p>0,035 MC    40 pcs    15,5* kg    17,5 kg</p> <p><b>TECHNICAL DETAILS / Dettagli tecnici</b>  <b>TOP MAX</b></p>  <p>Ø400    730    Ø76    600x600    Ø800</p>	<p>ab à partir de 159.-</p>
	<p><b>TONDA 4154 R</b>  <b>Tischgestell</b>, mit Fussraster. Sockel aus Edelstahl poliert, verchromte Säule oder pulverbeschichtet.</p> <p><b>Pied haute</b>, avec repose-pieds sur la colonne. Base en acier inox poli et colonne en acier chromé ou thermolaqué</p> <p><b>PACKING / Imballo</b></p>  <p>0,030 MC    36 pcs    17* kg    19 kg</p> <p><b>TECHNICAL DETAILS / Dettagli tecnici</b>  <b>TOP MAX</b></p>  <p>Ø400    1100    Ø76    Ø700</p>	<p>ab à partir de 239.-</p>







Abbildung / image	Artikel - Bezeichnung / description d'article	Preis Prix CHF
	<p><b>STEP 4610</b>  <b>Tischgestell</b>, runder Sockel aus Gusseisen sandgestrahlt oder lackiert. Säule aus Stahlrohr lackiert oder verchromt. Verfügbar auch mit rundem Sockel 550mm (Art. 4630), D 600mm (Art. 4130)</p> <p><b>Pied</b>, base ronde en fonte sablée colonne en acier thermolaqué ou chromé. Disponible aussi avec base ronde D 550mm (art.4630), D 600mm (art.4130)</p> <p><b>PACKING / Imballo</b></p>  <p>0,043 MC    32 pcs    14* kg    16 kg</p> <p><b>TECHNICAL DETAILS / Dettagli tecnici</b>  <b>TOP MAX</b></p>  <p>Ø440    730    Ø76    650x650    Ø900</p>	<p>ab à partir de 179.-</p>
	<p><b>STEP 4614</b>  <b>Steh Tischgestell</b>, runder Sockel aus Gusseisen sandgestrahlt oder lackiert. Säule aus Stahlrohr lackiert oder verchromt. verfügbar mit rundem Sockel 550mm (Art. 4634), D 600mm (Art. 4134) oder mit Doppelplatte und Sockel D. 440 mm (art.4615)</p> <p><b>Pied haut</b>, base ronde en fonte sablée o epoxy. Colonne en acier thermolaqué ou chromé Disponible avec base ronde D 550mm (art.4634), D 600mm (art.4134) ou avec double plateau et base D 440mm (art. 4615).</p> <p><b>PACKING / Imballo</b></p>  <p>0,036 MC    32 pcs    15,5* kg    17,5 kg</p> <p><b>TECHNICAL DETAILS / Dettagli tecnici</b>  <b>TOP MAX</b></p>  <p>Ø440    1100    Ø76    Ø700</p>	<p>ab à partir de 209.-</p>



Abbildung / image	Artikel - Bezeichnung / description d'article	Preis Prix CHF
	<p><b>DREAM 4803</b>  <b>Tischgestell</b>, Sockel aus Edelstahl poliert und verchromtem Rohr.</p> <p><b>Pied</b>, en acier inoxydable poli et tube chromée.</p> <p><b>PACKING / Imballo</b></p> <p>0,049 mc    28 pcs    13* Kg    15 Kg</p> <p><b>TECHNICAL DETAILS / Dettagli tecnici</b></p> <p>Ø400    730    Ø60    Ø800</p>	<p>ab à partir de 179.-</p>
	<p><b>DREAM 4811</b>  <b>Tischgestell</b>, Sockel aus Edelstahl matt und satinierte konische Säule.          Verfügbar auch mit Säule aus Edelstahl poliert und verchromter Säule.</p> <p><b>Pied</b>, base en acier inox mat et colonne conique satinée.          Aussi disponible avec colonne en acier inoxydable poli et colonne chromée.</p> <p><b>PACKING / Imballo</b></p> <p>0,145 mc    20 pcs    21 Kg</p> <p><b>TECHNICAL DETAILS / Dettagli tecnici</b></p> <p>Ø460    710    Ø280    650x650    Ø900</p>	<p>ab à partir de 429.-</p>



Abbildung / image	Artikel - Bezeichnung / description d'article	Preis Prix CHF
	<p><b>DREAM 4820</b>  <b>Tischgestell</b> mit konischer Säule in verschiedene Farben. Pulverbeschichteter Sockel 400x400mm  <b>Pied</b>, colonne conique en différentes couleurs. Base thermolaqué.</p> <p><b>PACKING / Imballo</b></p>  <p>0,049 mc    28 pcs    20 Kg</p> <p><b>TECHNICAL DETAILS / Dettagli tecnici</b></p>  <p>400x400    730    Ø180    800x800</p>	<p>ab à partir de 339.-</p>
	<p><b>DREAM 4823</b>  <b>Tischgestell</b>, sandgestrahlter Sockel aus Gusseisen und Edelstahlsäule. Pulverbeschichtet.  <b>Pied</b>, de table en fonte sablée mm et colonne en acier inoxydable thermolaqué.</p> <p><b>PACKING / Imballo</b></p>  <p>0,049 mc    28 pcs    18,5* Kg    20,5 Kg</p> <p><b>TECHNICAL DETAILS / Dettagli tecnici</b></p>  <p>400x400    730    Ø60    800x800</p>	<p>ab à partir de 210.-</p>







Abbildung / image	Artikel - Bezeichnung / description d'article	Preis Prix CHF
	<p><b>DREAM 4830</b>  <b>Tischgestell</b>, Sockel aus sandgestrahltem Gusseisen und Säule aus Edelstahl.  <b>Pied</b>, de table en fonte sablée Ø460mm et colonne en acier inoxydable.</p> <p><b>PACKING / Imballo</b></p>  <p>0,049 mc    28 pcs    14* Kg    18,5 Kg</p> <p><b>TECHNICAL DETAILS / Dettagli tecnici</b></p>  <p>Ø460    730    Ø260    650x650    Ø900</p>	<p>ab à partir de 189.-</p>
	<p><b>DREAM 4841</b>  <b>Tischgestell</b>, Sockel aus Edelstahl matt und satinierte konische Säule.          Verfügbar auch mit Sockel aus Edelstahl poliert und verchromter Säule.  <b>Pied</b>, inox mat et colonne conique satinée. Aussi disponible avec base en acier inoxydable poli et colonne chromée.</p> <p><b>PACKING / Imballo</b></p>  <p>0,145 mc    20 pcs    30 Kg</p> <p><b>TECHNICAL DETAILS / Dettagli tecnici</b></p>  <p>Ø560    715    Ø280    900x900    Ø1300</p>	<p>ab à partir de 559.-</p>







Abbildung / image	Artikel - Bezeichnung / description d'article	Preis Prix CHF
	<p><b>DREAM 4843</b>  <b>Tischgestell</b>, sandgestrahlter Sockel aus Gusseisen und Edelstahlsäule, pulverbeschichtet.  <b>Pied</b>, en fonte sablée et colonne en acier inoxydable, laqué époxy.</p> <p><b>PACKING / Imballo</b></p>  <p>0,054 mc    24 pcs    25* Kg    26,5 Kg</p> <p><b>TECHNICAL DETAILS / Dettagli tecnici</b></p>  <p>Ø560    730    Ø60    900x900    Ø1300</p>	<p>ab à partir de 209.-</p>
	<p><b>DREAM 4834</b>  <b>Tischgestell</b>, Sockel aus Edelstahl poliert, matt oder pulverbeschichtet, verchromte oder satinierte Edelstahlsäule.  <b>Pied haut</b>, de table en acier inox poli, mat ou thermolaqué, colonne en acier inox chromé ou satiné.</p> <p><b>PACKING / Imballo</b></p>  <p>0,058 mc    20 pcs    16* Kg    18 Kg</p> <p><b>TECHNICAL DETAILS / Dettagli tecnici</b></p>  <p>Ø460    1100    Ø60    Ø700</p>	<p>ab à partir de 209.-</p>





Abbildung / image	Artikel - Bezeichnung / description d'article	Preis Prix CHF
	<p><b>DREAM 4844</b>  <b>Tischgestell</b>, Sockel aus Edelstahl poliert, matt oder pulverbeschichtet, verchromte oder satinierte Edelstahlsäule.  <b>Pied haut</b>, de table en acier inox, mat ou thermolaqué, colonne en acier inox chromé ou satiné.</p> <p><b>PACKING / Imballo</b></p>  <p>0,063 mc    20 pcs    27 Kg</p> <p><b>TECHNICAL DETAILS / Dettagli tecnici</b></p>  <p>Ø560    1100    Ø60    Ø800</p>	<p>ab à partir de 299.-</p>

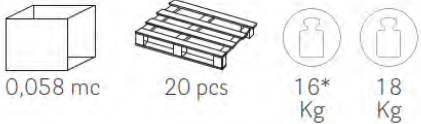







Abbildung / image	Artikel - Bezeichnung / description d'article	Preis Prix CHF
	<p><b>QUADRA 4160 REG</b>  <b>Tischgestell</b>, Sockel aus sandgestrahltem Gusseisen, Säule aus Edelstahl in verschiedenen Farben pulverbeschichtet. Edelstahl matt oder verchromt. Verfügbar auch in Höhe 1100 mm. (Artikel 4164). Mit Verstellgleitern.</p> <p><b>Pied</b>, base en fonte sablé colonne en tube thermolaqué dans différents coloris. Colonnes disponibles en acier inox brossé ou en acier chromée. Disponible en version hauteur 1100 mm (art. 4164). Avec vérins réglables.</p> <p><b>PACKING / Imballo</b></p>  <p>0,035 MC    40 pcs    20* kg    22 kg</p> <p><b>TECHNICAL DETAILS / Dettagli tecnici</b></p>  <p>400x400    730    80x80    TOP MAX    900x900</p>	<p>ab à partir de 179.-</p>
	<p><b>QUADRA 4560 REG</b>  <b>Tischgestell</b>, Sockel aus sandgestrahltem Gusseisen, Rohr aus Edelstahl in verschiedenen Farben pulverbeschichtet. Edelstahl matt, verchromter Stahl. Höhe 730 mm. Verfügbar auch Höhe 1100 mm (Artikel 4564). Mit Verstellgleitern.</p> <p><b>Pied</b>, base en fonte sablé, colonne en tube thermolaqué en différents coloris. Colonnes disponible en acier inox brossé ou en acier chromée. Disponible en version hauteur 1100 mm (art. 4564). Avec vérins réglables.</p> <p><b>PACKING / Imballo</b></p>  <p>0,051 MC    24 pcs    34 kg</p> <p><b>TECHNICAL DETAILS / Dettagli tecnici</b></p>  <p>710x400    730    2x 80x80    TOP MAX    1600x900</p>	<p>ab à partir de 359.-</p>



Abbildung / image	Artikel - Bezeichnung / description d'article	Preis Prix CHF
	<p><b>QUADRA 4570 REG</b>  <b>Tischgestell.</b> Sockel aus sandgestrahltem Gusseisen, Rohr aus Stahl pulverbeschichtet.                  Verfügbar auch in der Höhe 1100mm (Artikel 4574).</p> <p><b>Pied,</b> base en fonte sablé, colonne en tube d'acier thermolaqué dans différents coloris.                  Disponible en la version hauteur 1100 mm (art. 4574).</p> <p><b>PACKING / Imballo</b></p>  <p>0,035 MC    40 pcs    24 kg</p> <p><b>TECHNICAL DETAILS / Dettagli tecnici</b></p>  <p>600x410    730    80x80    TOP MAX                  1400x900                  1250x800 (HPL)</p>	<p>ab à partir de 259.-</p>











Abbildung / image	Artikel - Bezeichnung / description d'article	Preis Prix CHF
	<p><b>EASY 4361</b>  <b>Tischgestell</b>, Sockel aus Gusseisen, pulverbeschichtete oder furnierte Säule in verschiedenen Farben. Inkl. Verstellgleiter.</p> <p><b>Pied</b>, base en fonte, colonne thermolaquée dans différents coloris. Vérins réglables inclus.</p> <p><b>PACKING / Imballo</b></p>  <p>0,038 MC    32 pcs    19 kg</p> <p><b>TECHNICAL DETAILS / Dettagli tecnici</b>  <b>TOP MAX</b></p>  <p>750x750    730    80x80    1100x1100 Ø1500</p>	<p>ab à partir de 209.-</p>
	<p><b>EASY 4362</b>  <b>Tischgestell</b>, Sockel aus Gusseisen, pulverbeschichtete oder furnierte Säule in verschiedenen Farben. Verstellgleiter.</p> <p><b>Pied</b>, base en fonte, colonne thermolaquée dans différents coloris. Vérins réglables.</p> <p><b>PACKING / Imballo</b></p>  <p>0,038 MC    32 pcs    17,5 kg</p> <p><b>TECHNICAL DETAILS / Dettagli tecnici</b>  <b>TOP MAX</b></p>  <p>635x750    730    80x80    1200x800</p>	<p>ab à partir de 219.-</p>





Abbildung / image	Artikel - Bezeichnung / description d'article	Preis Prix CHF
	<p><b>EASY 4761</b>  <b>Tischgestell</b>, Sockel aus Gusseisen, pulverbeschichtete Säule in verschiedenen Farben. Inkl. Verstellgleiter.</p> <p><b>Pied</b>, base en fonte, colonne thermolaquée dans différents coloris. Vérins réglables inclus.</p> <p><b>PACKING / Imballo</b></p>  <p>0,031 MC    42 pcs    13* kg    15 kg</p> <p><b>TECHNICAL DETAILS / Dettagli tecnici</b>  <b>TOP MAX</b></p>  <p>635x635    730    Ø76    900x900- Ø1000</p>	<p>ab à partir de 169.-</p>
	<p><b>EASY 4381</b>  <b>Tischgestell</b>, Sockel aus Gusseisen, pulverbeschichtete oder furnierte Säule in verschiedenen Farben. Inkl. Verstellgleiter.</p> <p><b>Pied</b>, base en fonte, colonnes thermolaquées dans différents coloris. Vérins réglables inclus.</p> <p><b>PACKING / Imballo</b></p>  <p>0,031 MC    42 pcs    20 kg</p> <p><b>TECHNICAL DETAILS / Dettagli tecnici</b>  <b>TOP MAX</b></p>  <p>2x635x90    730    2x Ø76    1400x900</p>	<p>ab à partir de 229.-</p>





Abbildung / image	Artikel - Bezeichnung / description d'article	Preis Prix CHF
	<p><b>FLUXO 5465_H500</b>  <b>Tischgestell</b>, mit 4 Beinen. Basis aus druckgegossenem Aluminium und Säule aus extrudiertem Aluminium. Erhältliche Ausführungen: in poliertem oder lackiertem Aluminium.</p> <p><b>Pied</b>, de table à 4 pieds radiaux, piètement en aluminium moulé sous pression et colonne en aluminium extrudé. Versions disponibles: en aluminium poli ou laqué.</p> <p><b>PACKING / Imballo</b></p>  <p>0,087 MC    20 pcs    6 kg</p> <p><b>TECHNICAL DETAILS / Dettagli tecnici</b>  <b>TOP MAX</b></p>  <p>Ø680    500    Ø60    800x800    Ø900  490x490</p>	<p>ab à partir de 189.-</p>
	<p><b>FLUXO 5465</b>  <b>Tischgestell</b>, mit 4 Beinen. Basis aus druckgegossenem Aluminium und Säule aus extrudiertem Aluminium. Erhältliche Ausführungen: in poliertem oder lackiertem Aluminium.</p> <p><b>Pied</b>, de table à 4 pieds radiaux, piètement en aluminium moulé sous pression et colonne en aluminium extrudé. Versions disponibles: en aluminium poli ou laqué.</p> <p><b>PACKING / Imballo</b></p>  <p>0,067 MC    32 pcs    6,3* kg    8 kg</p> <p><b>TECHNICAL DETAILS / Dettagli tecnici</b>  <b>TOP MAX</b></p>  <p>Ø660    730    Ø60    800x800    Ø800  485x485</p>	<p>ab à partir de 199.-</p>

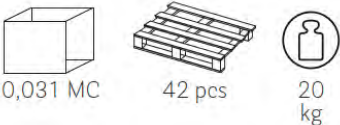
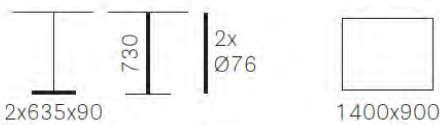

Abbildung / image	Artikel - Bezeichnung / description d'article	Preis Prix CHF
	<p><b>FLUXO 5466</b>  <b>Tischgestell</b>, mit 4 Beinen. Basis aus druckgegossenem Aluminium und Säule aus extrudiertem Aluminium. Erhältliche Ausführungen: in poliertem oder lackiertem Aluminium.</p> <p><b>Pied</b>, de table à 4 pieds radiaux, piètement en aluminium moulé sous pression et colonne en aluminium extrudé. Versions disponibles: en aluminium poli ou laqué.</p> <p><b>PACKING / Imballo</b></p>  <p>0,087 MC    20 pcs    6 kg</p> <p><b>TECHNICAL DETAILS / Dettagli tecnici</b></p> <p><b>TOP MAX</b></p>  <p>Ø680 490x490    500    Ø60    800x800    Ø900</p>	<p>ab à partir de 219.-</p>



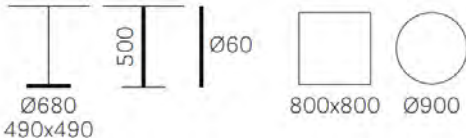

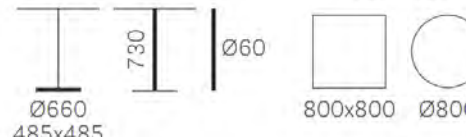
Abbildung / image	Artikel - Bezeichnung / description d'article	Preis Prix CHF
	<p><b>BOLD 4750</b> Tischgestell, Sockel aus Gusseisen 480x480, Rohr Ø50 mm. Pulverbeschichtet in diversen Farben</p> <p><b>Pied</b>, en fonte sablée 480x480, Tube Ø50 mm. Thermolaqué en divers couleurs</p> <p><b>PACKING / Imballo</b></p>  <p>0,035 MC    40 pcs    8,5* kg    10,5 kg</p> <p><b>TECHNICAL DETAILS / Dettagli tecnici</b> TOP MAX</p>  <p>Ø480 375x375    730    Ø50    700x700    Ø850</p>	<p>ab à partir de 139.-</p>
	<p><b>BOLD 4752</b> Tischgestell, Sockel aus Gusseisen 700x700, Rohr Ø50 mm. Pulverbeschichtet in diversen Farben</p> <p><b>Pied</b>, en fonte sablée 700x700, Tube Ø50 mm. Thermolaqué en divers couleurs</p> <p><b>PACKING / Imballo</b></p>  <p>0,035 MC    40 pcs    11* kg    13 kg</p> <p><b>TECHNICAL DETAILS / Dettagli tecnici</b> TOP MAX</p>  <p>Ø700 530x530    730    Ø50    900x900    Ø900</p>	<p>ab à partir de 169.-</p>

Abbildung / image	Artikel - Bezeichnung / description d'article	Preis Prix CHF
	<p><b>BOLD 4758</b> Tischgestell, Sockel aus Gusseisen 1000x530, Rohr Ø50 mm. Pulverbeschichtet in diversen Farben</p> <p><b>Pied</b>, en fonte sablée 1000x530, Tube Ø50 mm. Thermolaqué en divers couleurs</p> <p><b>PACKING / Imballo</b></p>  <p>0,035 MC    40 pcs    17* kg    21 kg</p> <p><b>TECHNICAL DETAILS / Dettagli tecnici</b> TOP MAX</p>  <p>980x530    730    2x Ø50    1600x900</p>	<p>ab à partir de 259.-</p>
	<p><b>BOLD 4756</b> Tischgestell, Sockel aus Gusseisen 700x700, Rohr Ø50 mm. Pulverbeschichtet in diversen Farben</p> <p><b>Pied</b>, en fonte sablée 700x700, Tube Ø50 mm. Thermolaqué en divers couleurs</p> <p><b>PACKING / Imballo</b></p>  <p>0,036 MC    32 pcs    11,5* kg    13,5 kg</p> <p><b>TECHNICAL DETAILS / Dettagli tecnici</b> TOP MAX</p>  <p>Ø700    1100    Ø50    700x700    Ø700 530x530</p>	<p>ab à partir de 189.-</p>

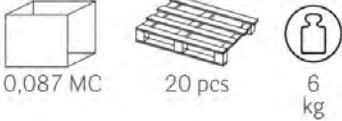
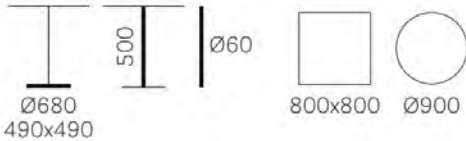



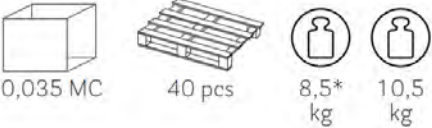
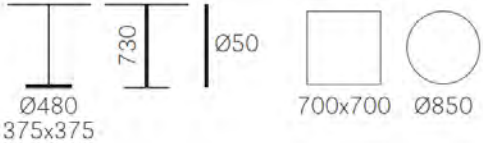

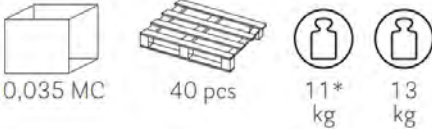
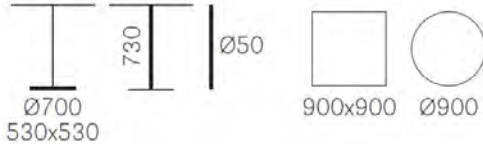

Abbildung / image	Artikel - Bezeichnung / description d'article	Preis Prix CHF
	<p><b>ZENITH 4741</b> Tischgestell, Sockel aus Edelstahl matt mit Verstellgleitern aus Gusseisen</p> <p>Pied, base en acier inox brossé. Vérins réglables en fonte satiné</p> <p><b>PACKING / Imballo</b></p>  <p>0,037 MC    32 pcs    10,6 kg</p> <p><b>TECHNICAL DETAILS / Dettagli tecnici</b></p> <p>TOP MAX</p>  <p>610x725    730    2x Ø50    1300x900</p>	<p>ab à partir de 279.-</p>
	<p><b>ZENITH 4746</b> Tischgestell, Sockel aus Edelstahl matt mit Verstellgleitern aus Gusseisen.</p> <p>Pied, base acier inox brossé. Vérins réglables en fusion d'acier satiné.</p> <p><b>PACKING / Imballo</b></p>  <p>0,040 MC    40 pcs    9,5 kg</p> <p><b>TECHNICAL DETAILS / Dettagli tecnici</b></p> <p>TOP MAX</p>  <p>Ø750    1100    Ø50    700x700    Ø800 540x540</p>	<p>ab à partir de 399.-</p>





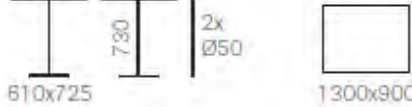



Abbildung / image	Artikel - Bezeichnung / description d'article	Preis Prix CHF
	<p><b>ZENITH 4748</b> Tischgestell, Sockel aus Edelstahl matt, mit Verstellgleitern aus Gusseisen</p> <p>Pied, base en acier inox brossé, vérins réglables en fusion d'acier satiné</p> <p><b>PACKING / Imballo</b></p> <div style="display: flex; justify-content: space-around; align-items: center;"> <div style="text-align: center;">  0,037 MC         </div> <div style="text-align: center;">  32 pcs         </div> <div style="text-align: center;">  10,6 kg         </div> </div> <p><b>TECHNICAL DETAILS / Dettagli tecnici</b></p> <div style="display: flex; justify-content: space-around; align-items: center;"> <div style="text-align: center;">  610x725         </div> <div style="text-align: center;">  730         </div> <div style="text-align: center;">  2x Ø50         </div> <div style="text-align: center;"> <p>TOP MAX</p>  1300x900         </div> </div>	<p>ab à partir de 489.-</p>









Abbildung / image	Artikel - Bezeichnung / description d'article	Preis Prix CHF
	<p><b>LAJA 5430_H500</b>  <b>Tischgestell</b>, mit 4 Beinen. Basis aus druckgegossenem Aluminium und Säule aus extrudiertem Aluminium. Erhältliche Ausführungen: in poliertem oder lackiertem Aluminium.</p> <p><b>Pied</b>, de table à 4 pieds radiaux, piètement en aluminium moulé sous pression et colonne en aluminium extrudé. Versions disponibles: en aluminium poli ou laqué.</p> <p><b>PACKING / Imballo</b></p>  <p>0,056 MC    20 pcs    6,5 kg</p> <p><b>TECHNICAL DETAILS / Dettagli tecnici</b>  <b>TOP MAX</b></p>  <p>Ø820 585x585</p> <p>400</p> <p>Ø50</p>  <p>900x900    Ø1000</p>	<p>ab à partir de 259.-</p>
	<p><b>LAJA 5430</b>  <b>Tischgestell</b>, mit 4 Beinen. Basis aus druckgegossenem Aluminium und Säule aus extrudiertem Aluminium. Erhältliche Ausführungen: in poliertem oder lackiertem Aluminium.</p> <p><b>Pied</b>, de table à 4 pieds radiaux, piètement en aluminium moulé sous pression et colonne en aluminium extrudé. Versions disponibles: en aluminium poli ou laqué.</p> <p><b>PACKING / Imballo</b></p>  <p>0,087 MC    20 pcs    6 kg</p> <p><b>TECHNICAL DETAILS / Dettagli tecnici</b>  <b>TOP MAX</b></p>  <p>Ø680 490x490</p> <p>500</p> <p>Ø60</p>  <p>800x800    Ø900</p>	<p>ab à partir de 249.-</p>



Abbildung / image	Artikel - Bezeichnung / description d'article	Preis Prix CHF
	<p><b>LAJA 5434</b>  <b>Tischgestell</b>, mit 4 Beinen. Basis aus druckgegossenem Aluminium und Säule aus extrudiertem Aluminium. Erhältliche Ausführungen: in poliertem oder lackiertem Aluminium.</p> <p><b>Pied</b>, de table à 4 pieds radiaux, piètement en aluminium moulé sous pression et colonne en aluminium extrudé. Versions disponibles: en aluminium poli ou laqué.</p> <p><b>PACKING / Imballo</b></p>  <p>0,065 MC    16 pcs    8 kg</p> <p><b>TECHNICAL DETAILS / Dettagli tecnici</b></p> <p>TOP MAX</p>  <p>Ø820    1100    Ø50    700x700    Ø800  585x585</p>	<p>ab  à partir de  279.-</p>

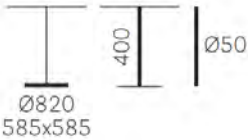
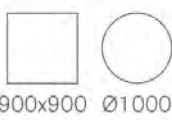

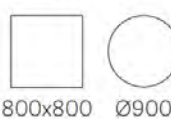

Abbildung / image	Artikel - Bezeichnung / description d'article	Preis Prix CHF
	<p><b>YPSILON 4797</b>  <b>Tischgestell</b>, mit 4 Beinen. Basis aus druckgegossenem Aluminium und Säule aus extrudiertem Aluminium. Erhältliche Ausführungen: in poliertem oder lackiertem Aluminium.</p> <p><b>Pied</b>, de table à 4 pieds radiaux, piètement en aluminium moulé sous pression et colonne en aluminium extrudé. Versions disponibles: en aluminium poli ou laqué.</p> <p><b>PACKING / Imballo</b></p>  <p>0,072 mc    32 pcs    5* Kg    7,2 Kg</p> <p><b>TECHNICAL DETAILS / Dettagli tecnici</b></p>  <p>Ø800    730    Ø60    900x900    Ø1000  585x585</p>	<p>ab à partir de 209.-</p>



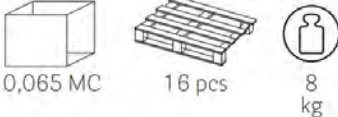
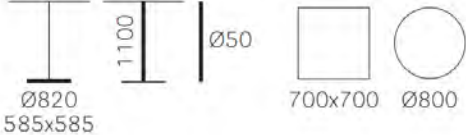







Abbildung / image	Artikel - Bezeichnung / description d'article	Preis Prix CHF
	<p><b>YPSILON 4795</b> Tischgestell, mit 4 Beinen, geeignet für runde und quadratische Tischplatten grösserer Dimensionen. Die Basis aus Aluminiumdruckguss sowie die Säule aus extrudiertem Aluminium, inkl. Verstellgleiter.</p> <p><b>Pied</b>, avec 4 pieds radiaux, pour plateaux de table ronds et carrés de grandes dimensions. La base en aluminium moulé sous pression et la colonne en aluminium extrudé. Vérins réglables inclus.</p> <div style="display: flex; justify-content: space-around;"> <div data-bbox="837 549 1128 703"> <p><b>PACKING / Imballo</b></p>  <p>0,10 MC    10 pcs    8,2 kg</p> </div> <div data-bbox="1301 549 1697 724"> <p><b>TECHNICAL DETAILS / Dettagli tecnici</b> TOP MAX</p>  <p>Ø965 730 Ø60 900x900 Ø1300 695x695 1200x900</p> </div> </div>	<p>ab à partir de 249.-</p>
	<p><b>YPSILON 4795V_H500</b> Tischgestell, mit 4 Beinen, geeignet für runde und quadratische Tischplatten grösserer Dimensionen. Aluminiumdruckguss sowie Säule aus extrudiertem Aluminium. Inkl. Verstellgleiter.</p> <p><b>Pied</b>, avec 4 pieds radiaux, pour plateaux de table ronds et carrés de grandes dimensions. Aluminium moulé sous pression et colonne en aluminium extrudé. Vérins réglables inclus.</p> <div style="display: flex; justify-content: space-around;"> <div data-bbox="860 1107 1173 1262"> <p><b>PACKING / Imballo</b></p>  <p>0,10 mc    10 pcs    7,9 Kg</p> </div> <div data-bbox="1346 1107 1765 1283"> <p><b>TECHNICAL DETAILS / Dettagli tecnici</b></p>  <p>Ø965 500 Ø60 900x900 Ø1300 695x695 1200x900</p> </div> </div>	<p>ab à partir de 249.-</p>

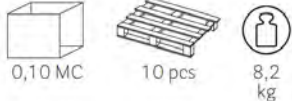
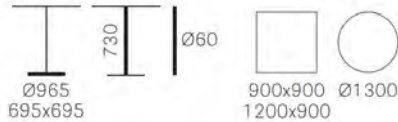

Abbildung / image	Artikel - Bezeichnung / description d'article	Preis Prix CHF
	<p><b>YPSILON 4794</b>  <b>Stehtischgestell</b>, Sockel und Säule aus extrudiertem Aluminium, mit Kompakt- oder Edelstahlplatte. Gummistopfen aus durchsichtigem PVC.</p> <p><b>Pied haut</b>, Base et colonne en aluminium extrudé, avec plaque compacte ou en acier inoxydable. Bouchon en PVC transparent.</p> <p><b>PACKING / Imballo</b></p>  <p>0,075 MC    24 pcs    5 kg</p> <p><b>TECHNICAL DETAILS / Dettagli tecnici</b>  <b>TOP MAX</b></p>  <p>Ø660    1100    Ø60    600x600    Ø600</p>	<p>ab à partir de 269.-</p>
	<p><b>YPSILON 4794T</b>  <b>Stehtischgestell</b>, Sockel und Säule aus extrudiertem Aluminium, mit Kompakt- oder Edelstahlplatte. Gummistopfen aus durchsichtigem PVC. Verfügbar fest oder klappbar.</p> <p><b>Pied haut</b>, Base et colonne en aluminium extrudé, avec plaque compacte ou en acier inoxydable. Bouchon en PVC transparent. Disponible fixe ou pliable.</p> <p><b>PACKING / Imballo</b></p>  <p>0,075 mc    24 pcs    5,3 Kg</p> <p><b>TECHNICAL DETAILS / Dettagli tecnici</b></p>  <p>Ø660    1080    Ø60    600x600    Ø600</p>	<p>ab à partir de 269.-</p>

# PEDRALI®



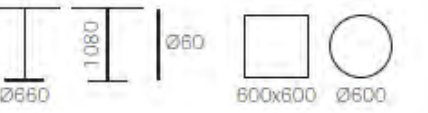

Abbildung / image	Artikel - Bezeichnung / description d'article	Preis Prix CHF
	<p><b>ELLIOT 5475_H500</b>  <b>Tischgestell</b>, mit 4 Beinen. Basis aus druckgegossenem Aluminium und Säule aus extrudiertem Aluminium. Erhältliche Ausführungen: in poliertem oder lackiertem Aluminium.</p> <p><b>Pied</b>, de table à 4 pieds radiaux, piètement en aluminium moulé sous pression et colonne en aluminium extrudé. Versions disponibles: en aluminium poli ou laqué.</p> <p><b>PACKING / Imballo</b></p>  <p>0,087 MC    20 pcs    6 kg</p> <p><b>TECHNICAL DETAILS / Dettagli tecnici</b></p> <p>TOP MAX</p>  <p>500    Ø680    490x490    800x800    Ø900</p>	<p>199.-</p>
	<p><b>ELLIOT 5475</b>  <b>Tischgestell</b>, mit 4 Beinen. Basis aus druckgegossenem Aluminium und Säule aus extrudiertem Aluminium. Erhältliche Ausführungen: in poliertem oder lackiertem Aluminium.</p> <p><b>Pied</b>, de table à 4 pieds radiaux, piètement en aluminium moulé sous pression et colonne en aluminium extrudé. Versions disponibles: en aluminium poli ou laqué.</p> <p><b>PACKING / Imballo</b></p>  <p>0,087 MC    20 pcs    6,5 kg</p> <p><b>TECHNICAL DETAILS / Dettagli tecnici</b></p> <p>TOP MAX</p>  <p>730    Ø680    490x490    800x800    Ø900</p>	<p>ab à partir de 209.-</p>







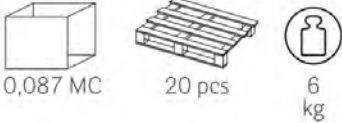
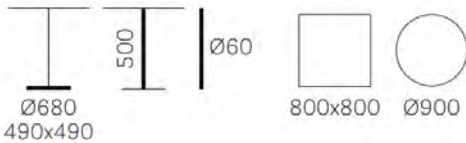

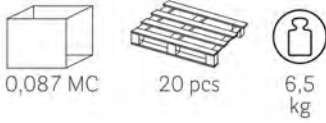
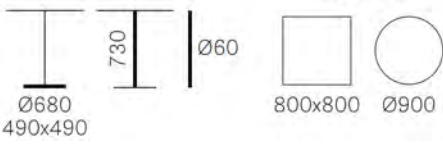
Abbildung / image	Artikel - Bezeichnung / description d'article	Preis Prix CHF
	<p><b>ELLIOT 5477</b>  <b>Tischgestell</b>, mit 4 Beinen. Basis aus druckgegossenem Aluminium und Säule aus extrudiertem Aluminium. Erhältliche Ausführungen: in poliertem oder lackiertem Aluminium.</p> <p><b>Pied</b>, de table à 4 pieds radiaux, piètement en aluminium moulé sous pression et colonne en aluminium extrudé. Versions disponibles: en aluminium poli ou laqué.</p> <p><b>PACKING / Imballo</b></p>  <p>0,114 MC    20 pcs    8,5 kg</p> <p><b>TECHNICAL DETAILS / Dettagli tecnici</b>  <b>TOP MAX</b></p>  <p>Ø850    730    Ø60          610x610</p>  <p>1000x1000    Ø1200</p>	<p>ab                  à partir de                  259.-</p>
	<p><b>ELLIOT 5476</b>  <b>Tischgestell</b>, mit 4 Beinen. Basis aus druckgegossenem Aluminium und Säule aus extrudiertem Aluminium. Erhältliche Ausführungen: in poliertem oder lackiertem Aluminium.</p> <p><b>Pied</b>, de table à 4 pieds radiaux, piètement en aluminium moulé sous pression et colonne en aluminium extrudé. Versions disponibles: en aluminium poli ou laqué.</p> <p><b>PACKING / Imballo</b></p>  <p>0,096 MC    16 pcs    7,2 kg</p> <p><b>TECHNICAL DETAILS / Dettagli tecnici</b>  <b>TOP MAX</b></p>  <p>Ø680    1080    Ø60          490x490</p>  <p>700x700    Ø800</p>	<p>ab                  à partir de                  259.-</p>



Abbildung / image	Artikel - Bezeichnung / description d'article	Preis Prix CHF
	<p><b>NOSTALGIE</b> Tischgestell, Sockel aus Gusseisen, Durchmesser Fuss 70cm Ø, lackiert Montagekreuz: 30x30cm, inkl. 3 Kunststoffgleiter, Höhe: 71cm</p> <p><b>NOSTALGIE</b> Pied, en fonte sablée, diamètre pied 70cm Ø, laqué Croix de montage: 30x30cm, 3 verins inclus, Hauteur: 71cm</p> <p>Empfohlen für runde Tischplatten bis Ø 90 cm, für quadratische Tischplatten nicht empfohlen. Recommandé pour les plateaux ronds jusqu'à Ø 90 cm, déconseillé pour plateaux carrées.</p>	379.-
	<p><b>NOSTALGIE</b> Tischgestell, Sockel aus Gusseisen, Durchmesser Fuss 70cm Ø, lackiert Montagekreuz: 30x30cm, inkl. 3 Kunststoffgleiter, Höhe: 107cm</p> <p><b>NOSTALGIE</b> Pied, en fonte sablée, diamètre pied 70cm Ø, laqué Croix de montage: 30x30cm, 3 verins inclus, Hauteur: 107cm</p> <p>Empfohlen für runde Tischplatten bis Ø 80 cm, für quadratische Tischplatten nicht empfohlen. Recommandé pour les plateau rondes jusqu'à Ø 80 cm, déconseillé pour plateaux carrées.</p>	449.-
	<p><b>NOSTALGIE</b> Tischgestell, Paar, Sockel aus Gusseisen Montagekreuz: Paar, 30x30cm, inkl. 4 Kunststoffgleiter verstellbar, Höhe: 71cm</p> <p><b>NOSTALGIE</b> Pied, paire, en fonte sablée, 60x60cm, laqué Croix de montage: 30x30cm, 4 verins réglables inclus, Hauteur: 71cm</p> <p>Empfohlen für rechteckige Tischplatten bis 100 cm Breite. Maximale Länge abhängig von Stabilität der Platte. Recommandé pour plateaux de table rectangulaires jusqu'à 100 cm de large. La longueur dépend de la stabilité du plateau.</p>	699.-

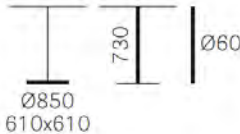
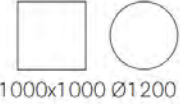

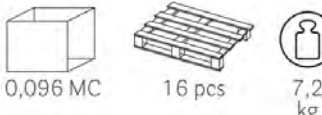

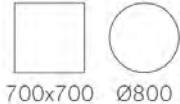





Abbildung / image	Artikel - Bezeichnung / description d'article	Preis Prix CHF
	<p><b>NOSTI</b> Tischgestell, Sockel aus Gusseisen 70x70cm, lackiert Montagekreuz: 30x30cm, inkl. 4 Kunststoffgleiter, Höhe: 71cm</p> <p><b>NOSTI</b> Pied, en fonte sablée, 70x70cm, laqué Croix de montage: 30x30cm, 4 verins inclus. Hauteur: 71cm</p> <p><b>NOSTI</b> Version Outdoor <b>NOSTI</b> Version Outdoor und KLAPPBAR</p> <p>Empfohlen für quadratische Tischplatten bis 100x100cm oder runde Tischplatten bis Ø 80cm Recommandé pour des plateaux carrés jusqu'à 100x100 cm ou des plateau ronds jusqu'à Ø 80cm</p>	 <p>Version: klappbar Outdoor</p> <p>419.-</p> <p>379.- 599.-</p>
	<p><b>NOSTI</b> Tischgestell, Sockel aus Gusseisen 70x70cm, lackiert Montagekreuz: 30x30cm, inkl. 4 Kunststoffgleiter, Höhe: 107cm</p> <p><b>NOSTI</b> Pied, en fonte sablée, 70x70, laqué Croix de montage: 30x30, 4 verins inclus, Hauteur: 107cm</p> <p>Empfohlen für quadratische Tischplatten bis 85x85cm oder runde Tischplatten bis Ø 85cm Recommandé pour des plateaux carrés jusqu'à 85x85cm ou des plateaux ronds jusqu'à Ø 85cm</p>	<p>479.-</p>
	<p><b>NOSTI</b> Tischgestell, Paar, Sockel aus Gusseisen Montagekreuz: 30x30cm, inkl. 4 Kunststoffgleiter, Höhe: 71cm</p> <p><b>NOSTI</b> Pied, paire, en fonte sablée, laqué Croix de montage: 30x30cm, 4 verins inclus, Hauteur: 71cm</p> <p>Empfohlen für rechteckige Tischplatten bis 90cm Breite. Maximale Länge ist abhängig von Stabilität der Platte. Recommandé pour les plateaux rectangulaires jusqu'à 90cm de large. La longueur dépend de la stabilité du plateau.</p>	<p>579.-</p>



Abbildung / image	Artikel - Bezeichnung / description d'article	Preis / Prix CHF
	<p><b>BISTROT 4101</b>  <b>Tischgestell</b> Gusseisen, sandgestraht, epoxy-polyester pulverbeschichtet.                  Piéd, en fonte sablée, thermolaqué.</p> <p><b>PACKING / Imballo</b></p> <p>  0,037 MC                          32 pcs                          21 kg                 </p> <p><b>TECHNICAL DETAILS / Dettagli tecnici</b></p> <p>TOP MAX</p> <p>  450x450                          800x800 Ø1000                 </p> <p>Weitere Modelle erhältlich! D'autres modèles sont disponibles!</p>	<p>ab                  à partir de                  229.-</p>



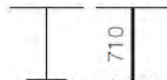



Abbildung / image	Artikel - Bezeichnung / description d'article	Preis Prix CHF
	<p><b>NOSTI 4</b> Tischgestell, Sockel aus Gusseisen 85 cm, lackiert Montageplatte: 49cm Ø, inkl. 4 Verstellgleiter, Höhe: 70cm</p> <p><b>NOSTI 4</b> Pied, en fonte sablée, 85 cm, laqué Plateau de montage: 49cm Ø, 4 verins réglables inclus, Hauteur: 70cm</p> <p>Empfohlen für quadratische Tischplatten bis 120x120 cm oder runde Tischplatten bis Ø 140cm Recommandé pour des plateaux carrés jusqu'à 120x120 cm ou des plateaux ronds jusqu'à Ø 140cm</p>	1'099.-
	<p><b>NOSTI 5</b> Tischgestell, Sockel aus Gusseisen 85 cm, lackiert Montageplatte: 49cm Ø, inkl. 5 Verstellgleiter, Höhe: 70cm</p> <p><b>NOSTI 5</b> Pied, en fonte sablée, 85 cm, laqué Plateau de montage : 49cm Ø, 5 verins réglables inclus, Hauteur: 70cm</p> <p>Empfohlen für runde Tischplatten bis Ø 140cm Recommandé pour des plateaux ronds jusqu'à Ø 140cm</p>	1'399.-
	<p><b>NOSTI 6</b> Tischgestell, Sockel aus Gusseisen 105cm, lackiert Montageplatte: 60cm Ø, inkl. 6 Verstellgleiter, Höhe: 70cm</p> <p><b>NOSTI 6</b> Pied, en fonte sablée, 105cm, laqué Plateau de montage : 60cm Ø, 6 verins réglables inclus, Hauteur: 70cm</p> <p>Empfohlen für runde Tischplatten bis Ø 220cm Recommandé pour des plateaux ronds jusqu'à Ø 220cm</p>	1'699.-



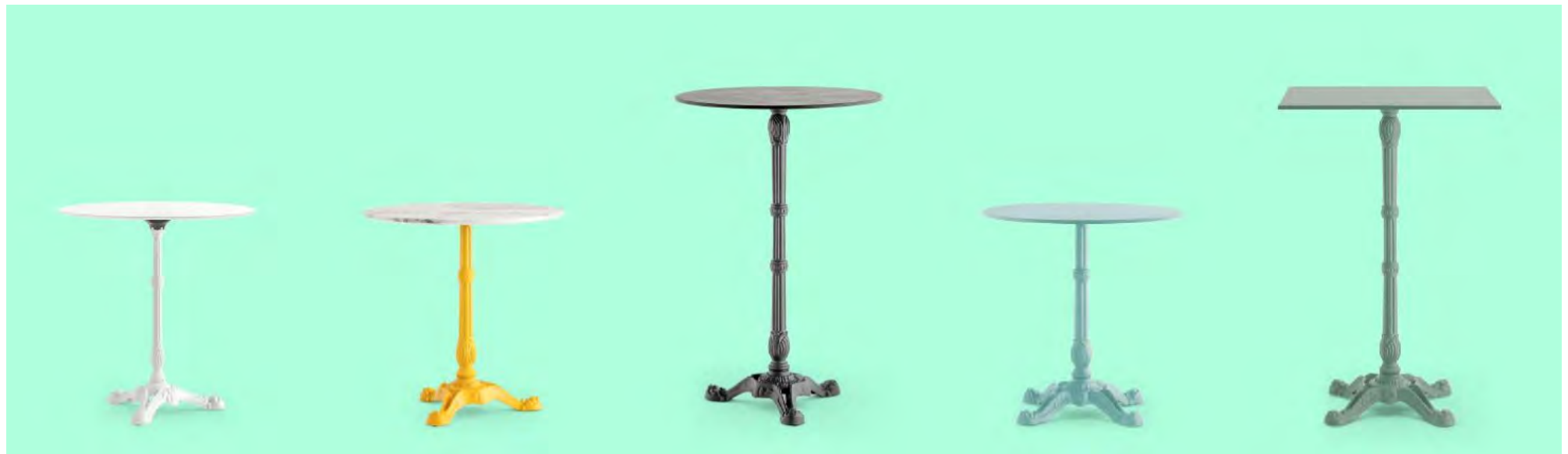

Abbildung / image	Artikel - Bezeichnung / description d'article	Preis Prix CHF
	<p><b>GERADE</b> Tischgestell, Sockel aus Gusseisen 61x61cm, lackiert Montagekreuz: 30x30cm, inkl. 4 Kunststoffgleiter, Standrohr Ø 5cm Stahl, Kreuzfuss 61x61cm, 4 Nivelliergleiter, Höhe 71cm Empfohlen für Tischplatten bis 85x85cm oder rund bis Ø 85cm</p> <p>Pied, en fonte sablée, 61x61cm, laqué Croix de montage: 30x30cm, 4 verins réglables inclus, Base en acier Ø 5cm, base en croix 61x61cm Hauteur: 71cm, Recommandé pour des plateaux jusqu'à 85x85cm ou des plateaux ronds jusqu'à Ø 85cm</p>	299.-
	<p><b>GERADE</b> Tischgestell, Sockel aus Gusseisen 70x70cm, lackiert Montagekreuz: 30x30cm, inkl. 4 Kunststoffgleiter, Standrohr Ø 6cm Stahl, Kreuzfuss 70x70cm, 4 Nivelliergleiter, Höhe 71cm, Empfohlen für Tischplatten bis 100x100cm oder rund bis Ø 100cm</p> <p>Pied, en fonte sablée, 70x70cm, laqué Croix de montage: 30x30cm, 4 verins réglables inclus, Base en acier Ø 6cm, base en croix 70x70cm Hauteur: 71cm Recommandé pour des plateaux jusqu'à 100x100cm ou des plateaux ronds jusqu'à Ø 100cm</p>	359.-
	<p><b>GERADE</b> Tischgestell, Sockel aus Gusseisen 61x61cm, lackiert Montagekreuz: 30x30cm, inkl. 4 Kunststoffgleiter, Standrohr Ø 5cm Stahl, Kreuzfuss 61x61cm, 4 Nivelliergleiter, Höhe: 107cm, Empfohlen für Tischplatten bis 70x70cm oder rund bis Ø 70cm</p> <p>Pied, en fonte sablée, 61x61cm, laqué Croix de montage: 30x30cm, 4 verins réglables inclus, Base en acier Ø 5cm, base en croix 61x61cm Hauteur: 107cm, Recommandé pour des plateaux jusqu'à 70x70cm ou des plateaux ronds jusqu'à Ø 70cm</p>	309.-
	<p><b>GERADE</b> Tischgestell, Paar, Sockel aus Gusseisen 61 cm, lackiert Montagekreuz: 30x30cm, inkl. 4 Kunststoffgleiter, Standrohr Ø 5cm Stahl, Kreuzfuss 61 cm, 4 Nivelliergleiter, Höhe: 71cm, Empfohlen für Tischplatten bis 240x90 cm.</p> <p>Pied, paire, en fonte sablée, 61x61cm, laqué Croix de montage: 30x30cm, 4 verins réglables inclus, Base en acier Ø 5cm, base en croix 61x61cm Hauteur: 71cm Recommandé pour les plateaux jusqu'à 240x90cm</p>	439.-





Abbildung / image	Artikel - Bezeichnung / description d'article	Preis Prix CHF
	<p><b>TRIVERS</b> Tischgestell, Sockel aus Gusseisen 60x60cm, Grauguss lackiert Montagekreuz: 30x30cm, inkl. 4 Nivelliergleiter Standrohr Ø 5cm Stahl, Höhe 71cm</p> <p><b>TRIVERS</b> Pied, en fonte sablée, 60x60cm, gris laqué Croix de montage: 30x30cm, 4 verins réglables inclus, Base en acier Ø 5cm, Hauteur: 71cm</p> <p>Empfohlen für quadratische Tischplatten bis 90x90cm oder runde Tischplatten bis Ø 90cm. Recommandé pour des plateaux de table jusqu'à 90x90cm ou des plateaux de table ronds jusqu'à Ø 90cm.</p>	299.-
	<p><b>TRIVERS</b> Tischgestell, Sockel aus Gusseisen 60x60cm, Grauguss lackiert Montagekreuz: 30x30cm, inkl. 4 Nivelliergleiter, Standrohr Ø 5cm Stahl, Höhe 107cm</p> <p><b>TRIVERS</b> Pied, en fonte sablée, 60x60cm, gris laqué Croix de montage: 30x30cm, 4 verins réglables inclus, Base en acier Ø 5cm, base en croix 61x61cm Hauteur: 107cm</p> <p>Empfohlen für quadratische Tischplatten bis 70x70cm oder runde Tischplatten bis Ø 70cm. Recommandé pour des plateaux de table jusqu'à 70x70cm ou des plateaux de table ronds jusqu'à Ø 70cm</p>	309.-
	<p><b>TRIVERS</b> Tischgestell, Paar, Sockel aus Gusseisen 60cm, lackiert Montagekreuz: 41x26cm, inkl. 4 Kunststoffgleiter Standrohr Ø 5cm Stahl, Fussbreite 60cm, 4 Nivelliergleiter, Höhe: 71cm</p> <p><b>TRIVERS</b> Pied, paire, en fonte sablée, 60cm, laqué Croix de montage: 41x26cm, 4 verins réglables inclus Base en acier Ø 5cm, base largeur: 60cm Hauteur: 71cm</p> <p>Empfohlen für Tischplatten bis 90cm Breite. Länge abhängig von Stabilität der Platte Recommandé pour les plateaux jusqu'à 90cm de large. La longueur dépend de la stabilité du plateau</p>	439.-



Abbildung / image	Artikel - Bezeichnung / description d'article	Preis Prix CHF
	<p><b>PILZ</b> Tischgestell, Sockel aus Gusseisen 37cm Ø, lackiert Montagekreuz: 30x30cm, inkl. 6 Kunststoffgleiter, Standrohr Ø 6cm Stahl, Höhe 71cm Empfohlen für quadratische Tischplatten bis 60x60 cm oder runde Tischplatten bis Ø 70cm</p> <p>Pied, en fonte sablée, 37cm Ø, laqué Croix de montage: 30x30cm, 6 verins réglables inclus, Base en acier Ø 6cm, Hauteur: 71cm Recommandé pour des plateaux de table carrés jusqu'à 60x60 cm ou des plateaux de table ronds jusqu'à Ø 70cm</p> <p>PILZ Ø 45cm (max. 70x70cm / Ø 90cm) PILZ Ø 52cm (max. 90x90cm / Ø 120cm) PILZ Ø 60cm (max. 100x100cm / Ø 140cm)</p>	<p>299.-</p> <p>349.- 399.- 639.-</p>
	<p><b>PILZ</b> Tischgestell, Sockel aus Gusseisen 73x45cm, lackiert Montagekreuz: 30x30cm, inkl. 6 Kunststoffgleiter, Standrohr Ø 6cm Stahl, Höhe 71cm Empfohlen für Tischplatten bis 140x80cm oder oval bis 150x90cm</p> <p>Pied, en fonte sablée, 73x45cm, laqué Croix de montage: 30x30cm, 6 verins réglables inclus, Base en acier Ø 6cm, Hauteur: 71cm Recommandé pour des plateaux jusqu'à 140x80cm ou des plateaux ovales jusqu'à 150x90cm</p>	<p>439.-</p>



Abbildung / image	Artikel - Bezeichnung / description d'article	Preis Prix CHF
	<p><b>PILZ</b> Tischgestell, Sockel aus Gusseisen, lackiert Montagekreuz: 30x30cm, inkl. 6 Kunststoffgleiter Standrohr Ø 6cm Stahl Höhe 107cm</p> <p>PILZ Ø 37 cm Stehtischfuss PILZ Ø 45 cm Stehtischfuss PILZ Ø 52 cm Stehtischfuss</p> <p><b>PILZ</b> Pied, en fonte sablée, 73x45cm, laqué Croix de montage: 30x30cm, 6 verins réglables inclus Base en acier Ø 6cm Hauteur: 107cm</p> <p>PILZ Ø 37 cm pied de table PILZ Ø 45 cm pied de table PILZ Ø 52 cm pied de table</p>	<p>299.- 399.- 439.-</p> <p>299.- 399.- 439.-</p>
	<p><b>PILZ</b> Tischgestell, Sockel aus Gusseisen, lackiert Montagekreuz: 30x30cm, inkl. 6 Kunststoffgleiter Standrohr Ø 6cm Stahl Höhe 107cm</p> <p>PILZ Ø 45 cm Stehtischfuss mit Fussring PILZ Ø 52 cm Stehtischfuss mit Fussring</p> <p><b>PILZ</b> Pied, en fonte sablée, 73x45cm, laqué Croix de montage: 30x30cm, 6 verins réglables inclus Base en acier Ø 6cm Hauteur: 107cm</p> <p>PILZ Ø 45 cm pied de table avec anneau de pied PILZ Ø 52 cm pied de table avec anneau de pied</p>	<p>499.- 569.-</p> <p>499.- 569.-</p>









Abbildung / image	Artikel - Bezeichnung / description d'article	Preis Prix CHF
	<p><b>HEXAGON</b> Tischuntergestelle sechseckig, Gusseisen/Stahl pulverbeschichtet schwarz/noir – pied hexagonale, fonte/acier thermolaqué noir</p> <p>421 638 Höhe: 73cm, Bodenplatte/ Plaque de base 46.8 x 49.4cm            421 640 Höhe: 73cm, Bodenplatte/ Plaque de base 54.0 x 56.6cm            421 639 Höhe: 106cm, Bodenplatte/ Plaque de base 46.8 x 49.4cm            421 641 Höhe: 106cm, Bodenplatte/ Plaque de base 54.0 x 56.5cm</p> 	<p>419.-            699.-            449.-            719.-</p>





Abbildung / image	Artikel - Bezeichnung / description d'article	Preis Prix CHF
	<p><b>Bases Tischuntergestelle rund, Piétement rond</b></p> <p>421 628 Höhe/Hauteur: 73cm, Bodenplatte/Plaque de base 40.5cm, Max. 80cm rund                      421 630 Höhe/Hauteur: 73cm, Bodenplatte/Plaque de base 56.5cm, Max. 100cm rund</p> <p>421 629 Höhe /Hauteur: 106cm, Bodenplatte/Plaque de base 40.5cm, Max. 70cm rund                      421 631 Höhe/Hauteur: 106cm, Bodenplatte/ Plaque de base 56.5cm, Max. 90cm rund</p>	<p>279.- 419.-</p> <p>269.- 399.-</p>
	<p><b>Bases Tischuntergestelle eckig, Piétement carré</b></p> <p>421 632 Höhe/Hauteur: 73cm, Bodenplatte/Plaque de base 40.5 x 40.5cm, Max. 60x60cm                      421 634 Höhe/Hauteur: 73cm, Bodenplatte/Plaque de base 55.5 x 55.5cm, Max. 100x100cm</p> <p>421 633 Höhe/Hauteur: 106cm, Bodenplatte/Plaque de base 40.5 x 40.5cm, Max. 70x70cm                      421 635 Höhe/Hauteur: 106cm, Bodenplatte/Plaque de base 55.5 x 55.5cm, Max. 90x90cm</p>	<p>289.- 419.-</p> <p>299.- 429.-</p>
	<p><b>Bases Tischuntergestell, Piétement</b></p> <p>421 636 Höhe/Hauteur: 73cm, Bodenplatte/Plaque de base 48.5 x 74.0cm, Max. 90x150cm                      421 637 Höhe/Hauteur: 106cm, Bodenplatte/Plaque de base 48.5 x 74.0cm, Max. 80x140cm</p>	<p>559.- 599.-</p>

SCAB  DESIGN  
since 1957





		<b>572</b> Carrera Marble Effekt	<b>574</b> Black Marble Effect
Form	Masse	CHF	CHF
	<b>70cm</b>	199.-	199.-
	<b>70x70cm</b>	199.-	199.-
	<b>80x80cm</b>	259.-	259.-



Montagekosten: CHF 30.- / Tisch - coût de montage: CHF 30.- / table

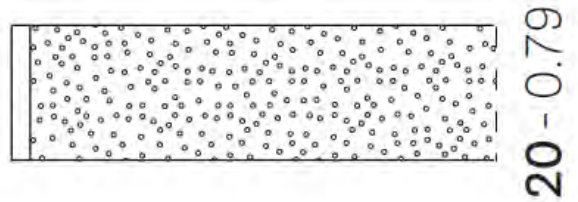

Platte mit Spanplattenkern, erhältlich in verschiedenen Formen und Grössen. Flache ABS-Kante verchromt. Dicke 20mm  
Plateaux avec âme en bois aggloméré, disponibles en différentes formes et tailles. Chant plat en ABS chromé, épaisseur 20 mm

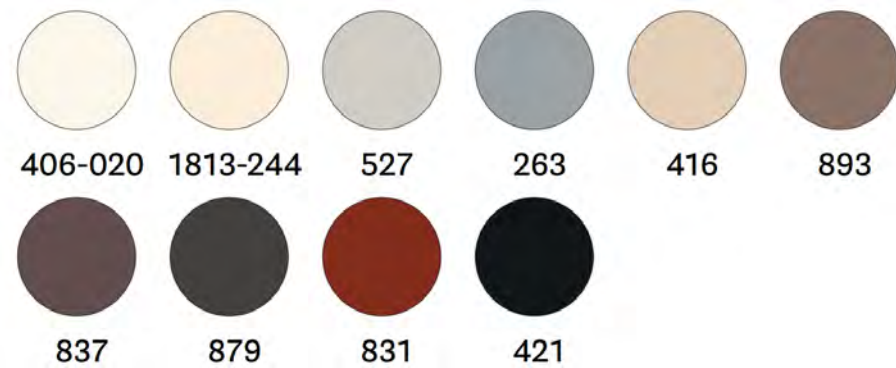

Grösse / dimensions	Flache ABS Kante verchromt / 20mm
Ø 600	99.-
Ø 700	139.-
Ø 800	159.-
Ø 900	199.-
Ø 1000	249.-
Ø 1200	379.-
Ø 1300	449.-
600x600	99.-
700x700	139.-
800x800	159.-
900x900	199.-
1000x600	159.-
1100x700	209.-
1200x800	239.-

Montagekosten: CHF 30.- / Tisch - coût de montage: CHF 30.- / table





FENIX NTM® - Platten mit Kern aus Multiplex und flacher Kante. Stärke 12mm. Nur in schwarz erhältlich  
 Plateaux en FENIX NTM® avec cœur en multiplis et chant plat. Epaisseur 12mm, disponible uniquement en noir



FENIX NTM®- Platten mit Kern aus Spanplatte und flacher Kante aus ABS. Stärke 20mm, 30mm oder 50mm. Erhältliche Farben:  
 Plateaux en FENIX NTM® avec chant plat en ABS et cœur en coupage de bois. Epaisseur 20mm, 30mm ou 50mm. Couleurs disponible:

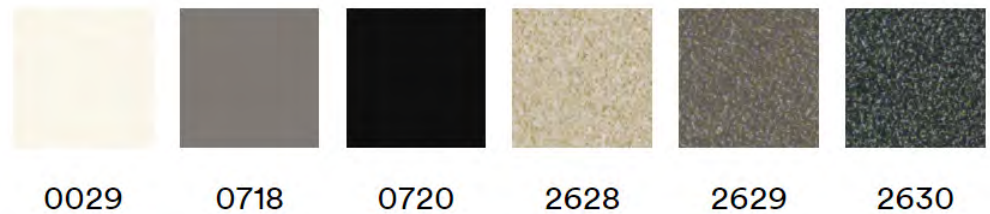

Grösse / dimensions	Fenix NTM Multiplex 12mm Flache Kante (nur schwarz) bord plat (uniquement noir)	Fenix NTM Spanplatte 20mm, ABS Kante Bord en ABS	Fenix NTM Spanplatte 30mm, ABS Kante Bord en ABS	Fenix NTM Spanplatte 50mm, ABS Kante Bord en ABS
Ø 490	199.-			
Ø 590	199.-	139.-	169.-	149.-
Ø 690	259.-	169.-	239.-	149.-
Ø 790	389.-	249.-	299.-	199.-
Ø 890	439.-	289.-	379.-	329.-
Ø 990	499.-	379.-	489.-	399.-
Ø 1190		579.-	789.-	689.-
Ø 1290		659.-	889.-	789.-
590x590	199.-	119.-	129.-	149.-
690x690	269.-	139.-	159.-	189.-
790x790	369.-	159.-	199.-	229.-
890x890	449.-	229.-	259.-	299.-
990x590		189.-	229.-	
1090x690	629.-	279.-	269.-	
1190x790	639.-	249.-	309.-	339.-
1290x790	739.-	449.-	359.-	
1390x790	799.-		379.-	399.-
1590x790	859.-		409.-	489.-

Montagekosten: CHF 30.- / Tisch - coût de montage: CHF 30.- / table

**FENIX NTM®** - ein extrem mattes Nanotech-Material - ein von Arpa Industriale entwickeltes innovatives Produkt für die Raumgestaltung. Die dekorative Oberfläche wird durch eine spezielle Nanotechnologie und den Einsatz eines besonderen Herstellverfahrens – der Elektronenstrahlhärtung – veredelt.

FENIX NTM ist außerdem sehr kratz-, abrieb- und scheuerfest und beständig gegen trockene Hitze. Es ist sehr schlagfest und resistent gegen säurehaltige und haushaltsübliche Reiniger. Es hat antibakterielle Eigenschaften, wodurch seine Oberfläche hygienisch und leicht zu reinigen ist. Es ist zudem wasserabweisend und schimmelsicher.

**FENIX NTM®** - un matériau nanotechnologique extrêmement mat - un produit innovant développé par Arpa Industriale pour la décoration intérieure. La surface décorative est améliorée par une nanotechnologie spéciale et l'utilisation d'un procédé de fabrication spécial - le durcissement par faisceau d'électrons.

FENIX NTM est également très résistant aux rayures, à l'abrasion et aux éraflures ainsi qu'à la chaleur sèche. Elle est très résistante aux chocs et aux nettoyants acides et ménagers. Il possède des propriétés antibactériennes, ce qui rend sa surface hygiénique et facile à nettoyer. Il est également hydrofuge et résistant à la moisissure.



Spanplatte laminiert mit flacher ABS Kante. Stärke 20mm, 30mm, 50mm  
Plateaux chipboard stratifié et chant ABS plat. Epaisseur 20mm, 30mm ou 50mm





Grösse/dimensions	Laminate 20mm ABS Kante Bord en ABS	Laminate 30mm ABS Kante Bord en ABS	Laminate 50mm ABS Kante Bord en ABS
Ø 490			
Ø 590	109.-	139.-	109.-
Ø 690	139.-	189.-	149.-
Ø 790	179.-	249.-	199.-
Ø 890	219.-	309.-	249.-
Ø 990	259.-	399.-	309.-
Ø 1190	389.-	599.-	529.-
Ø 1290	449.-	659.-	549.-
590x590	69.-	79.-	99.-
690x690	99.-	109.-	129.-
790x790	119.-	139.-	159.-
890x890	149.-	179.-	209.-
990x590	109.-	129.-	
1090x690	149.-	199.-	
1190x790	179.-	209.-	229.-
1290x790	339.-	239.-	
1390x790		239.-	269.-
1590x790		279.-	339.-

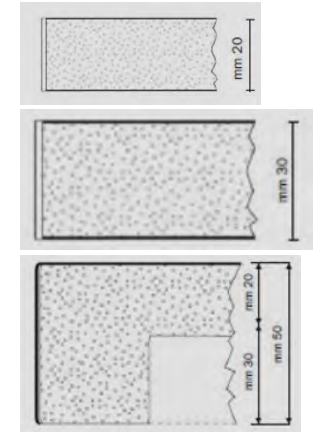

Montagekosten: CHF 30.- / Tisch - coût de montage: CHF 30.- / table



Compactplatten für Innenbereich mit schwarzem oder braunem Kern und schräger, flacher oder runder Kante. Stärke 10mm oder 12mm

Plateaux en stratifié fort épaisseur pour usage intérieur avec cœur noir ou marron et chant incliné, plat ou rond. Epaisseur 10mm ou 12mm

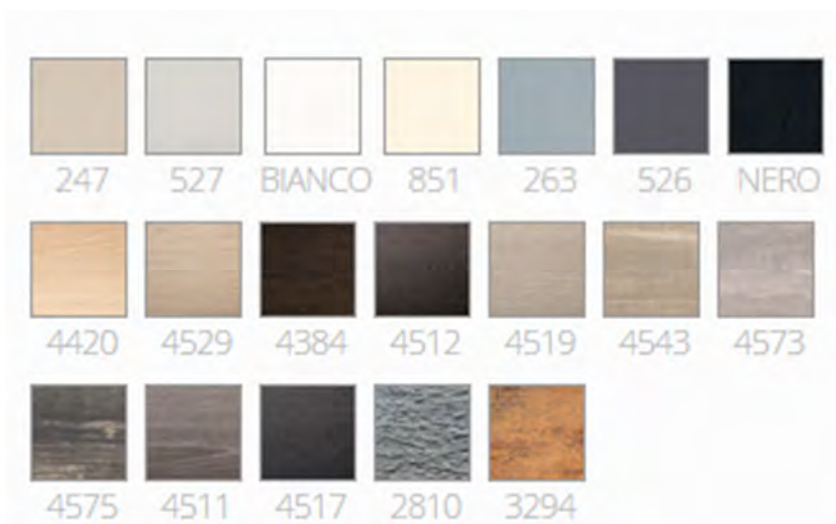

Kern – Farben / couleur coeur:

weiss/blanc: BIANCO

schwarz/noir : NERO, 526, BIANCO, 851, 263, 247, 527, 3294, 2810

braun/marron: 4420, 4384, 4529, 4512, 4519, 4543, 4573, 4575, 4511, 4517

Die Compact-Platten werden bei gemeinsamer Bestellung mit Untergestell, vorgebohrt und mit Gewinde versehen.

Les panneaux compacts sont percés lors de la commande avec une base et fileté.

Grösse	Compact 10mm weiss	Compact 10mm 247 / 527	Compact 10mm 4420 / 4384	Compact 10mm 4529/4512/4519/4543 4573/4575/4511/4517/3294	Compact 12mm schwarz /weiss 526 / 851	Compact 12mm 263/2810
Ø 490 rund	149.-	89.-	109.-	109.-	109.-	129.-
Ø 590 rund	209.-	119.-	129.-	129.-	129.-	139.-
Ø 690 rund	269.-	159.-	169.-	179.-	159.-	179.-
Ø 790 rund	329.-	209.-	209.-	229.-	209.-	329.-
Ø 890 rund	419.-	269.-	289.-	309.-	289.-	299.-
Ø 990 rund	549.-	319.-	329.-	349.-	329.-	339.-
Ø 1190 rund	899.-	579.-	599.-	649.-	599.-	629.-
Ø 1290 rund	969.-					
590x590	209.-	119.-	129.-	129.-	119.-	129.-
690x690	269.-	159.-	179.-	179.-	169.-	179.-
790x790	329.-	209.-	209.-	229.-	209.-	329.-
890x890	419.-	269.-	289.-	309.-	289.-	299.-
1090x690		369.-	379.-	419.-	389.-	399.-
1190x790	599.-	419.-	439.-	459.-	439.-	439.-
1290x790	659.-	439.-	469.-	499.-	469.-	399.-
1350x790		479.-	489.-	509.-	499.-	509.-
1590x790				599.-	539.-	559.-
1200x800 oval	559.-					
1600x950 oval	1'309.-					
1800x1100 oval	1'849.-					



möglich bei folgenden 10mm Platten: 247, 4420, 4384, 4529, 4512



möglich bei folgenden 10mm Platten: weiss



möglich bei folgenden 10mm Platten: 4519, 4543, 4573, 4575, 4511, 4517, 3294







möglich bei folgenden 12mm Platten: schwarz, weiss, 526, 851, 263, 2810

Montagekosten: CHF 30.- / Tisch - les coût de montage: CHF 30.- / table



# MAZUVO

Massiv Holzplatten EICHE  
plateaux de bois massif châne

Form Dicke / épaisseur: 30mm	Masse dimensions	NATUR lackiert/laqué oder geölt/huilé	
		Gerade Kante/bord plat 	CH-Kante/bord incliné 
	600 x 600mm	200.-	249.-
	700 x 700mm	260.-	299.-
	800 x 800mm	320.-	349.-
	600mm rund	200.-	215.-
	700mm rund	270.-	280.-
	800mm rund	340.-	360.-
	900mm rund	430.-	450.-
	1000mm rund	535.-	550.-
	1100mm rund	650.-	660.-
	1200mm rund	770.-	780.-
	1300mm rund	950.-	1'000.-
	1200 x 800mm	520.-	549.-
	1400 x 800mm	595.-	659.-
	1600 x 800mm	665.-	949.-
	1800 x 800mm	745.-	1'249.-

**Hinweis / Note:**

Die Preise verstehen sich ab 1 Stk. - Mengenrabatte gemäss individueller Offerte.

Prix pour 1 pcs. - rabais de quantité selon offre individuel.

Bei Platten grösser als 800 x 800mm bringen wir eine Metallverstärkung an (im Preis inbegriffen).

Pour des plateaux de table dépassant la dimension 800 x 800mm nous ajoutons un renfort métallique (inclus).

Sondergrössen auf Anfrage möglich! Dimension spéciales disponibles sur demande







# MAZUVO

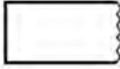

Massiv Holzplatten BUCHE  
plateaux de bois massif hêtre

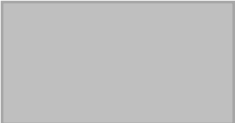

**Massiv Holzplatten BUCHE / plateaux de bois massif hêtre A-Qualität**

Form Dicke / épaisseur: 30mm	Masse dimensions:	NATUR lackiert/laqué		GEBEIZT + lackiert / tinté + laqué	
		Gerade Kante/bord incliné 	CH-Kante/bord incliné 	Gerade Kante/bord plat 	CH-Kante/bord incliné 
	600 x 600mm	200.-	210.-	230.-	240.-
	700 x 700mm	250.-	260.-	280.-	290.-
	800 x 800mm	300.-	310.-	340.-	350.-
	600mm rund	210.-	220.-	240.-	250.-
	700mm rund	260.-	270.-	290.-	300.-
	800mm rund	320.-	330.-	340.-	350.-
	1200 x 800mm	600.-	650.-	630.-	650.-
	1400 x 800mm	610.-	660.-	690.-	720.-
	1600 x 800mm	1'000.-	1'050.-	1'100.-	1'150.-
	1800 x 800mm	1'300.-	1'350.-	1'400.-	1'480.-

**Hinweis / Note:**

Die Preise verstehen sich ab 1 Stk. - Mengenrabatte gemäss individueller Offerte.

Prix pour 1 pcs. - rabais de quantité selon offre individuel.





Bei Platten grösser als 800 x 800mm bringen wir eine Metallverstärkung an (im Preis inbegriffen).

Pour des plateaux de table dépassant la dimension 800 x 800mm nous ajoutons un renfort métallique (inclus).

Sondergrössen auf Anfrage möglich! Dimension spéciales disponibles sur demande!

# MAZUVO

Massiv Holzplatten NUSSBAUM  
plateaux de bois massif noyer

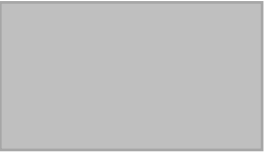
Form Dicke/épaisseur: 30mm	Masse dimensions	NATUR lackiert/laqué oder geölt/huilé	
		Gerade Kante/bord plat 	CH-Kante/bord incliné 
	600 x 600mm	375.-	999.-
	700 x 700mm	480.-	999.-
	800 x 800mm	630.-	999.-
	600mm rund	385.-	410.-
	700mm rund	500.-	530.-
	800mm rund	660.-	680.-
	900mm rund	830.-	860.-
	1000mm rund	1'000.-	1'050.-
	1100mm rund	1'250.-	1'300.-
	1200mm rund	1'450.-	1'500.-
	1300mm rund	1'850.-	1'900.-
	1200 x 800mm	980.-	1'000.-
	1400 x 800mm	1'150.-	1'200.-
	1600 x 800mm	1'280.-	1'350.-
	1800 x 800mm	1'400.-	1'450.-

### Hinweis / Note:

Die Preise verstehen sich ab 1 Stk. - Mengenrabatte gemäss individueller Offerte.

Prix pour 1 pcs. - rabais de quantité selon offre individuel.

Bei Platten grösser als 800 x 800mm bringen wir eine Metallverstärkung an (im Preis inbegriffen).

Pour des plateaux de table dépassant la dimension 800 x 800mm nous ajoutons un renfort métallique (inclus).

Sondergrössen auf Anfrage möglich! Dimension spéciales disponibles sur demande!



**MAZUVO**



Wählen Sie Grösse, Oberfläche, Stärke, Kanten....

Choisissez dimensions, surfaces, épaisseur, chantes...



SIGN  
HEY

HEY-SIGN





Wollfilz. Reine Schurwolle.







Abbildung / image	Artikel - Bezeichnung / description d'article	Preis Prix CHF																								
	<p><b>Welle Paravent</b> - Schalldämmender Filz-Raumtrenner Mit einer schalldämmenden Eigenschaft. Erhältliche Grössen:</p> <table border="0"> <tr> <td><u>1 Element</u></td> <td><u>2 Elemente</u></td> <td><u>Erweiterungselement</u></td> </tr> <tr> <td>60 x 125 x 9cm</td> <td>120 x 125 x 9cm</td> <td>60 x 125 x 9cm</td> </tr> <tr> <td>60 x 165 x 9cm</td> <td>120 x 165 x 9cm</td> <td>60 x 165 x 9cm</td> </tr> <tr> <td>80 x 125 x 9cm</td> <td>160 x 125 x 9cm</td> <td>80 x 125 x 9cm</td> </tr> </table> <p>Sondergrössen ab 10 Einzelementen auf Anfrage</p> <p><b>Welle Paravent</b> - Séparation de pièces en feutre insonorisant Avec une propriété d'absorption du son. Dimension disponibles:</p> <table border="0"> <tr> <td><u>1 élément</u></td> <td><u>2 élément</u></td> <td><u>élément d'extension</u></td> </tr> <tr> <td>60 x 125 x 9cm</td> <td>120 x 125 x 9cm</td> <td>60 x 125 x 9cm</td> </tr> <tr> <td>60 x 165 x 9cm</td> <td>120 x 165 x 9cm</td> <td>60 x 165 x 9cm</td> </tr> <tr> <td>80 x 125 x 9cm</td> <td>160 x 125 x 9cm</td> <td>80 x 125 x 9cm</td> </tr> </table> <p>Dimensions spéciales à partir de 10 éléments individuels sur demande</p>	<u>1 Element</u>	<u>2 Elemente</u>	<u>Erweiterungselement</u>	60 x 125 x 9cm	120 x 125 x 9cm	60 x 125 x 9cm	60 x 165 x 9cm	120 x 165 x 9cm	60 x 165 x 9cm	80 x 125 x 9cm	160 x 125 x 9cm	80 x 125 x 9cm	<u>1 élément</u>	<u>2 élément</u>	<u>élément d'extension</u>	60 x 125 x 9cm	120 x 125 x 9cm	60 x 125 x 9cm	60 x 165 x 9cm	120 x 165 x 9cm	60 x 165 x 9cm	80 x 125 x 9cm	160 x 125 x 9cm	80 x 125 x 9cm	<p>ab à partir de 1'489.-</p>
<u>1 Element</u>	<u>2 Elemente</u>	<u>Erweiterungselement</u>																								
60 x 125 x 9cm	120 x 125 x 9cm	60 x 125 x 9cm																								
60 x 165 x 9cm	120 x 165 x 9cm	60 x 165 x 9cm																								
80 x 125 x 9cm	160 x 125 x 9cm	80 x 125 x 9cm																								
<u>1 élément</u>	<u>2 élément</u>	<u>élément d'extension</u>																								
60 x 125 x 9cm	120 x 125 x 9cm	60 x 125 x 9cm																								
60 x 165 x 9cm	120 x 165 x 9cm	60 x 165 x 9cm																								
80 x 125 x 9cm	160 x 125 x 9cm	80 x 125 x 9cm																								

Diverse Ausführungen erhältlich / Différentes versions sont disponibles:









Abbildung / image	Artikel – Bezeichnung / description d'article	Preis Prix CHF
	<p><b>Welle Paravent gebogen</b> Schalldämmender Filz-Raumtrenner Mit einer schalldämmenden Eigenschaft. Erhältliche Grössen:</p> <p>1 Element: 80 x 125 x 9cm 2 Elemente: 160 x 125 x 9cm Erweiterungselement: 80 x 125 x 9cm Sondergrössen ab 10 Einzelementen auf Anfrage</p> <p><b>Welle Paravent courbé</b> Séparation de la salle en feutre insonorisant. Avec une propriété d'absorption du son.</p> <p>1 élément: 80 x 125 x 9cm 2 élément: 160 x 125 x 9cm élément d'extension: 80 x 125 x 9cm Dimensions spéciales à partir de 10 éléments individuels sur demande</p>	<p>ab à partir de</p> <p>1'859.- 3'099.- 1'699.-</p> <p>1'859.- 3'099.- 1'699.-</p>

Diverse Ausführungen erhältlich:





Abbildung / image	Artikel – Bezeichnung / description d'article	Preis Prix CHF
	<p><b>Deckenobjekt Welle mit Leuchte / Module plafond „onde“</b>  <u>Grössen / Dimensions</u>                      Model Welle S, mit Leuchte, avec luminaire, Durchmesser/diamètre: 40cm                      Model Welle M, mit Leuchte, avec luminaire, Durchmesser/diamètre: 60cm                      Modell Welle L, mit Leuchte, avec luminaire, Durchmesser/diamètre: 60cm</p> <p><u>Optionen für Leuchten: / Options pour lampes:</u>                      Dimmbar / Dimmable:                      Casambi / Casambi                      Tunable weiss für Leuchte S / pour lumière S                      Tunable weiss für Leuchte M+L / pour lumière M+L</p> 	<p>ab à partir de</p> <p>4'159.- 5'169.- 5'589.-</p> <p>69.- 259.- 389.- 519.-</p>
	<p><b>Hängemodul Welle / Module suspendue „onde“</b>                      Erhältliche Grössen / dimensions:                      150 x 40 x 9cm                      150 x 60 x 9cm</p> <p>150 x 40 x 9cm (Erweiterungsmodul)                      150 x 60 x 9cm (Erweiterungsmodul)</p> 	<p>1'299.- 1'699.-</p> <p>1'249.- 1'619.-</p>



Abbildung / image	Artikel – Bezeichnung / description d'article	Preis Prix CHF
	<p><b>Wandmodul Welle / module mur</b> Erhältliche Grössen / Dimensions:</p> <p>60 x 118 x 9cm 60 x 158 x 9cm 80 x 118 x 9cm 80 x 178 x 9cm</p>	<p>ab à partir de</p> <p>1'249.- 1'499.- 1'449.- 1'979.-</p>
	<p><b>Tischmodul Welle / module table „onde“</b> Erhältliche Grössen:/ dimensions</p> <p>150 x 43 x 9cm 150 x 63 x 9cm</p>	<p>ab à partir de</p> <p>1'299.- 1'599.-</p>

# MAZUVO

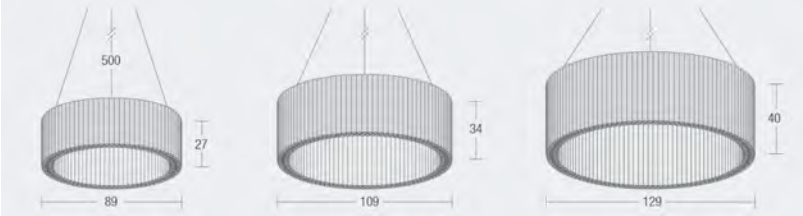
GARTEN- UND OBJEKTMÖBEL • SEIT 1959

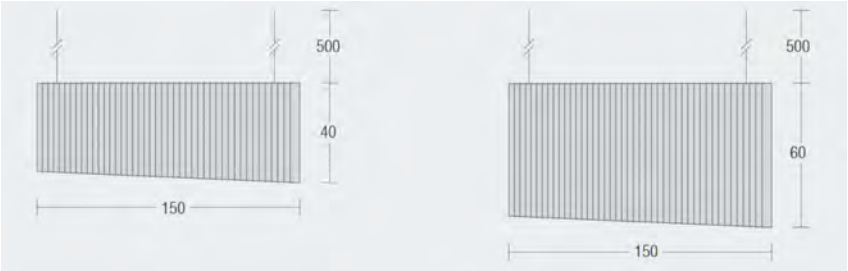
MAZUVO AG  
Brunnenstrasse 14  
CH-8604 Volketswil

E-Mail: [info@mazuvo.ch](mailto:info@mazuvo.ch)  
Tel. Zentrale: +41 44 908 26 26

[www.mazuvo.ch](http://www.mazuvo.ch)