

SEATING

PRICELIST
DESIGN SOLUTIONS

Valid from 1st February 2023

MAZUVO AG

€ = CHF

+8.1% MWST

2023

PEDRALI®

PEDRALI®

Seatings and fittings index

Indice sedute e accessori

SEATING / SEDUTE

Allure	022	Glam	091
Ara	022	Gliss	094
Arki-Bench	024	Gossip	105
Arki-Sofa	026	Grace	105
Arki-Stool	028	Happy	106
Arod	029	Héra	107
Babila	031	Host	108
Babila Comfort	045	Host lounge	110
Babila Twist	046	Ice	112
Babila XL	047	Ikon low stool	113
Blitz	051	Ikon Bench	114
Blume	052	Ila	117
Box	053	Inga	119
Brera	055	Intrigo	124
Buddy	061	Island	125
Buddyhub	066	Jamaica	126
Buddy Sofa	070	Jazz	128
Cube	072	Jeff	130
Cube XL	075	Jil	133
Dome	076	Joi	134
Dress	078	Koi-Booki	135
Elinor	080	Kuadra	136
Elle	081	Kuadra XL	148
Enjoy	081	Laja	159
Ester	081	Lamoris	163
Folk	086	Leila	163
Fox	089	Log	164
Frida	091	Malmö	165
		Modus	174

SEATING / SEDUTE

Modus 2.0	189	Soul	263
Mood	196	Souvenir	264
Mya	196	Sunset	265
Nemea	198	Tatami	268
Noa	200	Temps	268
Nolita	203	Tivoli	269
Nolita Sofa	207	Tribeca	272
Nym	208	Tweet	274
Osaka	224	Twig	284
Osaka Metal	226	TX	285
Panarea	229	Vic	287 - 288
Pasha	231	Vic Metal	287 - 288
Plural	234	Volt	291
Plus	240	Volt HB	295
Plus Air	240	Woody	297
Polar	242	Wow	298
Queen	244	Young	305
Rail	247	Zippo	309
Remind	245		
Reva	248		
Reva Cocoon	250	Fittings / Accessori	312
Reva Twist	249	Finishes / Finiture	320
Rubik	252		
Serif	253		
Sign	254		
Snow	255		
Snow junior	255		
Social	256		
Social Plus	260		

Condizioni generali di vendita e garanzia

AMBITO DI APPLICAZIONE

Le presenti condizioni generali disciplinano tutti gli attuali e futuri rapporti tra Pedrali Spa ed il compratore, salvo eventuali deroghe specificatamente concordate per iscritto.

PREZZI

I prezzi sono espressi in euro e sono Iva esclusa. Tutti i prezzi non comprendono dazi, tasse, imposte e spese di trasporto.

VALIDITÀ PREZZI

Il presente listino prezzi ha validità dal 1 Febbraio 2023 sino a nuova comunicazione.

Qualunque offerta o proposta comunicata da agenti o da terzi e non formalizzata direttamente da Pedrali Spa, sarà valida solo quando verrà approvata per iscritto dall'azienda. Le offerte emesse da Pedrali Spa hanno validità un mese dalla data di emissione, dopodiché l'azienda si riserva di rimettere una nuova offerta.

ORDINE MINIMO

Importo minimo di ogni ordine 400,00 euro netti.

Qualsiasi ordine di importo inferiore a 400,00 euro netti non è da ritenersi accettato fino a conferma scritta da parte di Pedrali Spa.

ACCETTAZIONE ORDINI

Si considerano validi solamente gli ordini ricevuti direttamente dal compratore.

Qualunque offerta o proposta comunicata da agenti o da terzi e non formalizzata direttamente da Pedrali Spa, è da ritenersi valida solo quando approvata per iscritto dall'azienda.

Per qualunque ordine di prodotti speciali non contemplati all'interno del presente listino deve essere fatta specifica richiesta. Pedrali Spa si riserva di valutarne la fattibilità, senza alcun impegno.

Gli ordini sono sempre subordinati all'accettazione di Pedrali Spa che si riserva la facoltà di rifiutarli entro 30 gg dalla ricezione.

In caso di richiesta della firma per accettazione da parte del compratore, l'ordine si considererà tale a partire dalla ricezione della conferma d'ordine firmata.

In caso di richiesta dell'acconto, l'ordine si considererà tale dalla ricezione dell'acconto.

MODIFICHE DI ORDINE

Sono da considerarsi modifiche eventuali riduzioni di quantità o modifica di articolo.

Aggiunte di quantità si considerano nuovi ordini che decorreranno dalla ricezione del nuovo ordine.

L'azienda prende in considerazione solo modifiche di ordini effettuate entro 48 ore dalla ricezione degli stessi.

Previa valutazione, Pedrali Spa comunicherà se possibile accettare tali modifiche.

I tempi di consegna decorreranno dalla data della modifica.

Non si potrà accettare, in ogni caso, più di una modifica per ordine.

Eventuali modifiche di indirizzi di consegna successive all'invio della conferma d'ordine prevedono un addebito di costi amministrativi di 200,00 euro netti.

ANNULLAMENTO ORDINE

È possibile annullare l'ordine entro 48 ore dalla ricezione della conferma d'ordine di Pedrali Spa. In seguito, l'annullamento non sarà più possibile.

Qualora il compratore dovesse, in ogni caso, per qualunque ragione dichiarare annullato l'ordine successivamente a tale fase, ovvero intendesse recedere dal contratto revocando l'ordine, eventuali acconti versati saranno trattenuti da Pedrali Spa a titolo di risarcimento danni, con diritto della stessa a richiedere al compratore ulteriori costi e spese sostenute per la produzione.

TEMPI DI CONSEGNA

I tempi di consegna sono indicativi; il compratore non potrà pretendere né l'annullamento totale o parziale dell'ordine, né il rimborso di danni nel caso di ritardi di consegne.

In caso di richiesta della firma per accettazione del compratore sulla conferma d'ordine, o di richiesta di acconto, i tempi di consegna

decorrono dalla data di ricezione degli stessi.

Per ordini ricevuti incompleti o contenenti prodotti in finiture, misure o varianti non appropriati, la data di consegna decorre dal momento in cui viene confermata la ricezione di informazioni complete e corrette.

Nel caso di imbottiti con tessuto cliente, i tempi di consegna decorrono dalla ricezione del tessuto e dalla conferma di fattibilità.

Nel caso di tinte a campione, i tempi di consegna decorrono dalla ricezione del campione.

MONTAGGIO E INSTALLAZIONE

I prodotti possono essere consegnati smontati. Il montaggio e l'installazione sono a carico del compratore e devono essere eseguiti da montatori specializzati, seguendo le istruzioni di montaggio fornite da Pedrali Spa.

IMBALLO

I nostri imballi sono adatti per trasporto a mezzo camion.

Eventuali imballi per trasporto via aerea devono essere specificati al momento dell'ordine. Il supplemento per l'imballo speciale è di 200,00 euro netto per ordine, cui si aggiungono 40,00 euro lordi a bancale.

La merce disposta su bancali non può essere sbancalata. I bancali non possono essere sovrapposti.

I cartoni sfusi devono essere movimentati sempre mantenendo il lato alto indicato sul cartone.

Per sedie/sgabelli con imballo standard multiplo è possibile richiedere imballo singolo, ove possibile, con un supplemento di 7,00 euro lordo (IVA esclusa) a pezzo.

In caso di richiesta di pallet conforme alla normativa FAO ISPM 15, la richiesta deve essere avanzata al momento dell'ordine e prevede un supplemento di 40,00 euro lordi per ogni pallet.

PRODOTTI PER UTILIZZO ALL'ESTERNO

Solo i prodotti contrassegnati dall'apposito simbolo, sono garantiti per utilizzo all'esterno.

Verande, piscine, centri termali, navi e location in prossimità dal mare, sono considerati ambienti esterni anche se non esposti direttamente a sole, pioggia e salsedine.

Si consiglia un rimessaggio protetto nel periodo di non utilizzo.

RESA DELLA MERCE

La merce è venduta EX WORKS e viaggia a rischio e pericolo del committente.

Eventuali prezzi DAP/DDP devono essere concordati tra le parti e indicati espressamente nella conferma d'ordine.

In ogni caso nessuna responsabilità potrà essere imputata a Pedrali Spa, qualora si verificano casi di ammanco o avaria di varia natura causati durante lo stivaggio, il caricamento o il trasporto.

È nell'interesse del compratore verificare quantità e condizioni dell'imballo della merce prima del ritiro, facendo eventuali opportune riserve al corriere se necessario.

In caso di riserva, Pedrali Spa si renderà disponibile a chiedere il rimborso al corriere. In caso di assenza di riserva, Pedrali Spa declinerà ogni responsabilità. Eventuali danni devono essere comunicati entro e non oltre 8 giorni dalla ricezione della merce, e comunque prima che i prodotti vengano utilizzati.

L'indirizzo di destinazione dovrà essere quello del compratore. Nel caso il destinatario richieda la sponda idraulica, la richiesta dovrà essere avanzata al momento dell'ordine, con il costo di 130,00 euro netti.

Consegne ad un indirizzo diverso dal magazzino del compratore, devono essere concordate preventivamente tra le parti al momento dell'ordine. Devono altresì essere forniti un nominativo e un contatto telefonico del destinatario.

GARANZIA

La garanzia si applica per un periodo di 24 mesi su vizi e difetti di produzione nelle normali condizioni d'uso previste per ogni singolo prodotto.

Tale garanzia decorre dalla data di fatturazione.

La garanzia opera e si applica soltanto a condizione che:

- i prodotti siano utilizzati nell'ambito dell'uso consentito
- i prodotti siano installati da tecnici qualificati secondo le istruzioni fornite da Pedrali Spa
- i prodotti non siano stati modificati o manomessi da terzi
- i prodotti non siano stati montati/abbinati a componenti non forniti da Pedrali Spa
- i prodotti imbottiti non siano stati rivestiti con tessuti forniti dal cliente. Non viene garantita la qualità della tappezzeria con materiali non forniti direttamente da Pedrali Spa
- i prodotti siano stati mantenuti o conservati correttamente come previsto dalle istruzioni di uso e manutenzione
- i prodotti siano stati interamente pagati

RECLAMI

Ogni reclamo relativo a prodotti difettosi deve essere trasmesso per iscritto dall'acquirente direttamente a Pedrali Spa, entro 8 giorni dalla data della scoperta di vizio/difetto, pena di decadenza, con l'indicazione espressa del modello, della data di consegna, della descrizione del difetto e relative immagini, indicando anche la quantità dei prodotti difettosi.

Senza queste informazioni il reclamo non sarà considerato valido.

MODALITÀ DI ACCETTAZIONE DELLA GARANZIA

Qualora Pedrali Spa riconoscesse il vizio/difetto, potrà scegliere di sostituire/riparare i prodotti difettosi o proporre un prodotto alternativo con le medesime caratteristiche essenziali.

Qualora la riparazione o la sostituzione si rivelasse impossibile o superasse il costo del valore dei prodotti difettosi, Pedrali Spa potrà recedere dal contratto accettando il reso della merce con trasporto a carico dell'acquirente e rimborsando il prezzo di acquisto (spese di trasporto, installazione escluse).

Pedrali Spa non accetta altri tipi di penali o rimborsi spese.

RESI

Non si accettano resi di merce senza preventiva autorizzazione scritta da Pedrali Spa, la quale, in assenza di questa, si riserva il diritto di respingere la merce al mittente.

I resi di merce autorizzata devono essere inviati in porto franco, in perfetto stato e con imballo originale. In caso contrario Pedrali Spa si riserva il diritto di addebitare al compratore i costi sostenuti per la riparazione e la sostituzione dell'imballo.

La merce per la quale il reso è stato autorizzato sarà accreditata al costo di acquisto e gravata dal rimborso spese nella misura convenzionale del 20%.

PRODOTTI IGNIFUGHI

Eventuali certificazioni di reazione a fuoco devono essere richieste al momento dell'ordine, non possono essere richieste successivamente alla conferma d'ordine.

MODIFICHE DI PRODOTTI

Pedrali Spa si riserva il diritto di apportare in ogni momento, a suo insindacabile giudizio e senza necessità di preavviso, migliorie o modifiche ai propri prodotti.

Le descrizioni, illustrazioni, dati tecnici contenuti in cataloghi, listini, sito, ecc. di Pedrali Spa non hanno carattere vincolante.

PAGAMENTI

I pagamenti devono essere indirizzati direttamente a Pedrali Spa, salvo diverse indicazioni sulla conferma d'ordine.

RISERVA DI PROPRIETÀ

La proprietà dei prodotti rimarrà di Pedrali Spa fino a quando non verrà effettuato l'intero pagamento del relativo importo.

LEGGE APPLICABILE-CONTROVERSIE

Per quanto non previsto nelle presenti condizioni si applica la legge italiana.

Per qualsiasi controversia è esclusivamente competente il Foro di Bergamo.

DISCLAIMER

Pedrali Spa declina ogni responsabilità per danni a cose e persone causati da utilizzo improprio del prodotto, anche derivanti da una destinazione d'uso non preventivamente comunicataci e approvata da parte di Pedrali Spa.

General terms and conditions of sale and warranty

SCOPE OF APPLICATION

These present general conditions govern all current and future relationships between Pedrali Spa and the buyer, except for any exceptions specifically agreed upon in writing.

PRICES

Prices are expressed in euro, VAT excluded. All prices do not include tariffs, taxes, fees and shipping costs.

PRICE VALIDITY

This price list is valid from 1 February 2023 until further notice.

Any offer or proposal communicated by agents or third parties and not formalized directly by Pedrali Spa shall be valid only when it is approved in writing by the company. The offers issued by Pedrali Spa are valid for one month from the date of issue, after which the company reserves the right to issue a new offer.

MINIMUM ORDER

The minimum amount of each order is 400,00 euro, net of VAT.

Any order of an amount less than 400,00 euro (net of VAT) shall not be considered accepted until written confirmation is provided by Pedrali Spa.

ORDER ACCEPTANCE

Orders shall only be considered valid if they are received directly from the buyer.

Any offer or proposal communicated by agents or third parties and not formalized directly by Pedrali Spa shall be considered valid only when its approved in writing by the company.

Any order of special products not included in this price list must be the subject of a specific request. Pedrali Spa reserves the right to evaluate their feasibility, without any obligation.

Orders are always subject to acceptance by Pedrali Spa, that reserves the right to refuse them within 30 days of receipt.

In the event the buyer's signature is requested for acceptance, the order shall be considered concluded only upon receipt of the signed order confirmation.

In the event a down payment is requested, the order shall be considered concluded upon receipt of the payment.

ORDER CHANGES

Any reductions in quantity or changes in articles are to be considered as changes to the order.

Added quantities shall be considered new orders, with times calculated from receipt of the new order.

The company shall only consider order changes made within 48 hours of receipt of the orders.

Subject to the evaluation of the request, Pedrali Spa shall communicate whether it is possible to accept the changes.

Delivery times shall be calculated from the date of the change.

In any event, no more than one change is permitted per order.

Any changes to the delivery address after the transmission of the order confirmation shall entail a charge of 200,00 euro (net of VAT) for administrative costs.

ORDER CANCELLATION

Orders may be cancelled within 48 hours of receipt from the order confirmation by Pedrali Spa. Subsequently, cancellation will no longer be possible.

If the buyer, in any event and for any reason whatsoever, declare the cancellation of the order after such time, or intend to withdraw from the contract and revoke the order, any down payments shall be withheld by Pedrali Spa as compensation for damages. Pedrali Spa also reserves the right to request additional costs and expenses sustained for production from the buyer.

DELIVERY TIMES

Delivery times are indicative; the buyer may not claim the total or partial cancellation of the order, nor reimbursement for damages in the case of delivery delays.

In the event the buyer's signature is requested on the order confirmation, or a down payment is requested, the delivery times shall be calculated from receipt of the same.

For orders that are incomplete when received or improperly indicate the finishings, measurements or versions of the products, the delivery date shall be calculated from the receipt of complete or correct information.

In the case of upholstery with the client's fabric, the delivery times shall be calculated from receipt of the fabric and confirmation of feasibility. In the case of colors based on a sample, the delivery times shall be calculated from the receipt of the sample.

ASSEMBLY AND INSTALLATION

The products may be delivered disassembled. Assembly and installation are the responsibility of the buyer and must be performed by specialized assemblers, following the assembly instructions provided by Pedrali Spa.

PACKAGING

Our packaging materials are suitable for transport by truck.

Any packaging for air transport must be specified at the time of the order. The supplement for special packaging is 200,00 euro per order (net of VAT), to which 40,00 euro shall be added per pallet.

Goods arranged on pallets may not be depalletized. Pallets may not be stacked.

Loose boxes must always be handled with the correct side up.

For chairs/stools with multiple standard packaging, it is possible to request single packaging, where possible, with a supplement charge of gross 7,00 euro per item.

In the case of requests for pallets compliant with FAO ISPM 15 standards, the request shall be made at the time of the order, and entail a supplement charge of gross 40,00 euro per pallet.

PRODUCTS FOR EXTERNAL USE

Only products marked with the specific symbol are guaranteed for external use.

Verandas, pools, spas, ships and locations near the sea are considered external environments even if they are not directly exposed to the sun, rain and sea salt.

Products must be stored in a protected area when not in use as recommended.

DELIVERY TRADE TERMS

Goods are sold EX WORKS and shipping is at the risk and peril of the client.

Any DAP/DDP prices must be agreed upon by the parties and expressly indicated in the order confirmation.

In any event, no liability may be attributed to Pedrali Spa in the event of any shortages or problems of any kind caused during stowage, loading or shipping.

It is the buyer's responsibility to verify the quantity and conditions of the packaged goods before receipt, indicating any appropriate reservations to the courier where necessary.

In the event of reservations, Pedrali Spa shall request reimbursement from the courier. In the absence of any reservations, Pedrali Spa shall decline any liability.

Any damages must be notified by no later than 8 days of receipt of the goods and in any event before the products are used.

The delivery address must be that of the buyer.

In the event the recipient requests a tail lift, the request must be made at the time of the order, with a cost of 130,00 euro (net of VAT).

Deliveries to an address other than the buyer's warehouse must be agreed upon in advance between the parties at the time of the order. A name and telephone number of the recipient must also be provided.

WARRANTY

The warranty applies for a period of 24 months on production flaws and defects in normal conditions of use for each single product.

The warranty applies from the invoice date.

The warranty shall apply subject to the following conditions:

- the products are used in the permitted area of use
- the products are installed by qualified technicians following the instructions provided by Pedrali Spa
- the products have not been modified or altered by third parties
- the products have not been assembled/combined with components not supplied by Pedrali Spa
- Upholstered products have not been covered with fabric supplied by the client. No warranty is provided for the quality of upholstery with materials not supplied directly by Pedrali Spa
- the products have been maintained or preserved properly as indicated by the instructions for use and maintenance
- the products have been paid for in full

COMPLAINTS

Any complaints relating to defective products must be notified in writing by the buyer directly to Pedrali Spa within 8 days of the date the flaw/defect is discovered, on penalty of forfeiture, expressly indicating the model, delivery date, a description of the defect and the respective images, and also indicating the quantity of defective products.

Without such information, the complaint shall not be considered valid.

METHOD OF ACCEPTANCE OF WARRANTY

If Pedrali Spa acknowledges the flaw/defect, it may choose to replace/repair the defective products or offer an alternative product with the same essential characteristics.

Should repair or replacement turn out to be impossible or exceed the value of the defective products, Pedrali Spa may withdraw from the contract accepting the return of the goods with shipping costs covered by the buyer and reimbursing the purchase price (shipping costs and installation excluded).

Pedrali Spa shall not accept any other types of liabilities or penalties or expense reimbursements.

RETURNS

The return of goods shall not be accepted without written authorization from Pedrali Spa, which in the absence of such authorization, reserves the right to reject the goods from the sender.

Authorized returns of goods must be sent with carriage paid, in perfect condition and in the original packaging. In the absence of such conditions, Pedrali Spa reserves the right to charge the buyer for the costs sustained for the repair and replacement of the packaging.

The goods for which return has been authorized shall be credited at the purchase cost and subject to expense reimbursement at the conventional rate of 20%.

FIREPROOF PRODUCTS

Any reaction-to-fire certifications must be requested at the time of the order, and cannot be requested after order confirmation.

PRODUCT ALTERATIONS

Pedrali Spa reserves the right to make improvements or alterations to its products at any time, at its sole discretion and without the need to provide advance notice.

The descriptions, illustrations and technical data contained in the Pedrali Spa catalogues, price lists, website, etc. shall not be binding.

PAYMENTS

Payments must be sent directly to Pedrali Spa, unless otherwise indicated on the order confirmation.

RETENTION OF TITLE

Pedrali Spa remains the proprietor of the products until full payment is made of any respective amounts.

APPLICABLE LAW-DISPUTES

Any matters not covered by these conditions shall be subject to the laws of Italy.

Any disputes shall be under the exclusive jurisdiction of the Courts of Bergamo.

DISCLAIMER

Pedrali Spa accepts no responsibility for damages to things and people caused by an improper use of the product, also arising from an intended use, not previously notified to and approved by Pedrali Spa.

Legend

Legenda

FS	Bleached beech / Faggio sbiancato
FR	Bleached ash / Frassino sbiancato
RS	Bleached oak / Rovere sbiancato
W	Oak stained wenge / Rovere tinto wengé
N1	Oak/ash stained light walnut / Rovere/frassino tinto noce chiaro
EB	Ebony / Ebanò
ZB	Zebrano / Zebrano
N	Walnut / Noce
AN	Black lacquered oak/ash with visible grains, beech stained black Rovere/frassino laccato nero a poro aperto, faggio tinto nero
BI	White lacquered oak/ash with visible grains / Rovere/frassino laccato bianco a poro aperto
RA	Pink lacquered oak/ash with visible grains / Rovere/frassino laccato rosa a poro aperto
GC	Light grey lacquered oak/ash with visible grains / Rovere/frassino laccato grigio chiaro a poro aperto
BL2	Dark blue lacquered oak/ash with visible grains / Rovere/frassino laccato blu scuro a poro aperto
AZ1	Light blue lacquered oak/ash with visible grains / Rovere/frassino laccato azzurro a poro aperto
VE1	Light green lacquered oak/ash with visible grains / Rovere/frassino laccato verde chiaro a poro aperto
VE2	Dark green lacquered oak/ash with visible grains / Rovere/frassino laccato verde scuro a poro aperto
RB	Ruby red lacquered oak/ash with visible grains / Rovere/frassino laccato rosso rubino a poro aperto
MO	Mahogany lacquered oak/ash with visible grains / Rovere/frassino laccato mogano a poro aperto
MC	Cognac lacquered oak/ash with visible grains / Rovere/frassino laccato cognac a poro aperto
V101	Grey vintage / Finitura grigio anticato
V102	Wenge vintage / Finitura wengé anticato
V103	Walnut vintage / Finitura noce anticato
NY	Nylon / Nylon
PET	Polyethylene / Polietilene
PPL	Polypropylene / Polipropilene
PC	Polycarbonate / Policarbonato
SCR	Chromed ABS / ABS cromato
TP	Tecnopolymer / Tecnopolimero
ME	Methacrylate / Metacrilato
B	Padded with cat. B / Imbottitura con cat. B
C	Padded with cat. C / Imbottitura con cat. C
D	Padded with cat. D / Imbottitura con cat. D
E	Padded with cat. E / Imbottitura con cat. E
F	Padded with genuine or regenerated leather / Rivestimento in cuoio naturale o rigenerato
G	Padded with cat. G / Imbottitura con cat. G
H	Padded with cat. H / Imbottitura con cat. H
N	Padded with cat. N / Imbottitura con cat. N
P	Padded with cat. P / Imbottitura con cat. P
TXT	Waterproof textile mesh / Rete tessile impermeabile

Legend

Legenda

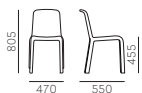

All dimensions are in millimeters
Tutte le dimensioni sono espresse in millimetri



Number of pieces per box and volume of carton in cubic meters
Numero di pezzi contenuti nell'imballo e volume in metri cubi del cartone

KD

Disassembled product
Prodotto da assemblare



Number of cartons per pallet
Numero di cartoni contenuti su pallet



Stackable product
Prodotto impilabile



Weight of a single product in Kgs
Peso del singolo prodotto espresso in chilogrammi



Product suitable for outdoor use
Prodotto adatto per utilizzo in esterni



Product not recommended for outdoor use
Prodotto non adatto per utilizzo in esterni



Product with swivel seat
Prodotto con seduta girevole



Swivel seat with spring back device
Prodotto con seduta girevole e meccanismo di ritorno automatico



FSC™ certified product
Prodotto certificato FSC™



PRODUCT CERTIFIED
FOR LOW CHEMICAL
EMISSIONS
UL.COM/IGG
UL 2818

GREENGUARD certified product
Prodotto certificato GREENGUARD

Outdoor seating / Sedute per esterno



ARA

BABILA
Powder coated
Verniciata

BABILA XL
Powder coated
Verniciata

BABILA TWIST

DOME



KOI-BOOKI

GOSSIP

HAPPY

GRACE
410/ALE, 410/AC

ICE

INTRIGO



JOI

KUADRA
1151/AC

ENJOY

MYA
Powder coated
Verniciata

TRIBECA



NOLITA

NOLITA SOFA

PANAREA



PLUS

PLUS AIR
BI, RO

PASHA
BI, FU, TR



ARKI-SOFA

Outdoor seating / Sedute per esterno



SOUL



LAMORISSE



REVA



REVA TWIST



REVA COCOON



RAIL



SUNSET



TATAMI



REMINDE



SOUVENIR



SERIF



VOLT



VOLT HB



SNOW



HOST lounge
790/AC, 792/AC



QUEEN
BI, SA, FU, AM,
TR, VL



RUBIK
BI, SA, FU, RT, TR, VL



WOW



IKON-BENCH



ARKI-BENCH

Plastic materials / Materie plastiche

Technopolymer and steel / Tecnopolimero e acciaio



KUADRA



KUADRA XL



GLISS lounge



GLISS swing



BABILA

Technopolymer and ash
Tecnopolimero e frassino



GLISS wood



BABILA



KUADRA

Technopolymer and stainless steel
Tecnopolimero e inox



GLISS



GLISS lounge

Technopolymer and aluminium
Tecnopolimero e alluminio

Polypropylene / Polipropilene



PLUS



SNOW



SNOW junior



ARA



ARA lounge



ENJOY



TATAMI



REMIND



VOLT



VOLT HB



DOME



HAPPY



GOSSIP



SOUVENIR



Polypropylene and ash / Polipropilene e frassino



BABILA



BABILA XL



FOX

Polypropylene and aluminium / Polipropilene e alluminio



KOI-BOOKI



MYA



JOI



ICE



TWEET



BABILA



PLURAL

Plastic materials / Materie plastiche

Polypropylene and steel / Polipropilene e acciaio



Polypropylene and stainless steel Polipropilene e acciaio inox



GRACE

Polyethylene and stainless steel Polietilene e acciaio inox



HOST lounge

Polyethylene / Polietilene



Polycarbonate / Policarbonato



Polycarbonate and steel Policarbonato e acciaio



Polycarbonate and aluminium Policarbonato e alluminio



Polycarbonate and ash Policarbonato e frassino



Chromed ABS and steel ABS cromato e acciaio



AROD

Plastic materials / Materie plastiche

Thermoformed methacrylate
Metacrilato termoformato



PASHA
tray / vassoio

Steel / Acciaio



NOLITA



PANAREA



BABILA TWIST



RAIL

Aluminium / Alluminio



TRIBECA



INTRIGO

SOUL

LAMORISSE



REVA

Plywood / Multistrato

Plywood and steel / Multistrato e acciaio



KUADRA

KUADRA XL

INGA

BABILA

WOODY

OSAKA metal



TX

Wood / Legno

Oak / Rovere



Oak and steel / Rovere e acciaio



Beech / Faggio



Ash / Frassino



Ash and aluminium / Frassino e alluminio



Ash and steel / Frassino e acciaio



Walnut / Noce





Elenco prodotti in plastica con certificazione di reazione al fuoco

CLASSE 1

Polypropylene / Polipropilene



SNOW
300 (BI)
pag. 255



KOI-BOOKI
370 (BI)
pag. 135



ARA
310, 315 (BI)
pag. 22



JOI
870 (BI, GA)
pag. 134



ICE
800, 850 (BI, GA)
pag. 112



VOLT
670, 675 (BI)
pag. 292



DOME
260, 265 (BI)
pag. 76



TWEET
890, 891/3, 892, 893, 893F, 894, 895, 896, 897, 898, 899 (any colour / tutti i colori)
pag. 274

French certification M2 and German certification B1 are available as well
Sono disponibili anche i certificati francese M2 e tedesco B1



PLURAL
Any model
Tutti i modelli
pag. 234

Polycarbonate / Policarbonato



QUEEN
650 (TR)
pag. 244



BLITZ
640 (TR, BI)
pag. 51



GLISS
921 (TR)
pag. 96



PASHA
660, 661 (TR, BI)
pag. 231



RUBIK
580 (TR, BI)
pag. 252



Classificazione di reazione al fuoco ed omologazione ai fini della prevenzione incendi

CLASSE 1.IM (UNO I EMME)



BABILA
Any model
Tutti i modelli
pag. 31

BABILA XL
Any model
Tutti i modelli
pag. 49

BLUME
Any model
Tutti i modelli
pag. 52

BUDDY
Any model
Tutti i modelli
pag. 61

BUDDY Sofa
Any model
Tutti i modelli
pag. 70

BUDDYHUB
Any model
Tutti i modelli
pag. 66



CUBE
1400, 1401
pag. 72



DRESS
Any model
Tutti i modelli
pag. 78



ELINOR
3755
pag. 80



ESTER
Any model
Tutti i modelli
pag. 81



FOLK
Any model
Tutti i modelli
pag. 86



FOX
3723, 3724
pag. 89



GLAM
430, 431, 435
pag. 91



GLISS
980, 1020
pag. 99



HÉRA
2865, 2869
pag. 107



HOST
Any model
Tutti i modelli
pag. 108



HOST lounge
791, 793
pag. 111



ILA
Any model
Tutti i modelli
pag. 117



INGA
5683, 5684, 5685,
5686, 5689
pag. 120



JAMAICA
2911, 2916
pag. 126



JAZZ
3716, 3717,
3718, 3719
pag. 128



JIL
520, 525, 526
pag. 133



KUADRA
1010, 1132
pag. 140



KUADRA XL
2441, 2442, 2443, 2444, 2481,
2482, 2483, 2484, 2491,
2492, 2493, 2494, 4429
pag. 151



LAJA
Any model
Tutti i modelli
pag. 159



LEILA
681, 682
pag. 163



LOG
Any model
Tutti i modelli
pag. 164



MALMÖ
242, 246, 296,
298, 391, 396
pag. 166



MODUS
Any model
Tutti i modelli
pag. 174



MODUS 2.0
Any model
Tutti i modelli
pag. 189



NEMEA
Any model
Tutti i modelli
pag. 198



NYM Soft
Any model
Tutti i modelli
pag. 210



OSAKA Metal
5721, 5722
pag. 226



SIGN
455
pag. 254



SOCIAL
Any model
Tutti i modelli
pag. 256



SOCIAL Plus
Any model
Tutti i modelli
pag. 260



TEMPS
3765
pag. 268



TIVOLI
Any model
Tutti i modelli
pag. 270



TWEET
Any model
Tutti i modelli
pag. 278



VIC
Any model
Tutti i modelli
pag. 287



VIC Metal
Any model
Tutti i modelli
pag. 287



VOLT
671/2, 676/2,
677/2, 678/2
pag. 292



VOLT HB
Any model
Tutti i modelli
pag. 296



WOW
Any model
Tutti i modelli
pag. 298



YOUNG
Any model
Tutti i modelli
pag. 307

CATEGORIE DI TESSUTO:

SIMIL LEATHER / Finta pelle cat. C60÷C64, C90÷C95, C130÷C141, H82÷H89, H20÷H35; H100÷H108

WOOL / Lana cat. G21÷G24, G110÷G116

FABRIC / Tessuto cat. C110÷C122, C210÷C217, D40÷D44, G59÷G78; G190÷G197, G100÷G102, G120÷G122, G130÷G133, G140÷G146, G150÷G156, G170÷G176; G210÷G213, G200÷G206, G160÷G169, H60÷H61, H120÷H127

VELVET / Velluto cat. G180÷G185, H40÷H53, N20÷N27

Su richiesta possiamo fornire la dichiarazione di conformità per i prodotti citati.

E' necessario che tale richiesta sia specificata per iscritto al momento dell'ordine al fine di poter allegare la dichiarazione valida solo per la fornitura in oggetto.

Allure 735



SEAT Sedile	BACK Schienale	FRAME Telaio	OAK Rovere
C Excluding / Escluso C36+C39	C	RS-W-N1- GC-BI	€ 553,00
G	G		€ 658,00
H Excluding / Escluso H140+H143	H		€ 570,00
P	P		€ 712,00

For fabrics see page 325
Per i tessuti si veda a p. 325

FINISHES / Finiture



PACKING / Imballo



TECHNICAL DETAILS / Dettagli tecnici



SAFETY, STRENGTH and DURABILITY TESTS
Prove di sicurezza, resistenza e durata
EN 1728:2012+AC2013
EN 16139:2013 level 2

Ara 310



SEAT Sedile	BACK Schienale	FRAME Telaio	POLYPROPYLENE Polipropilene
PPL	PPL	PPL	€ 85,00

PPL FINISHES / Finiture PPL

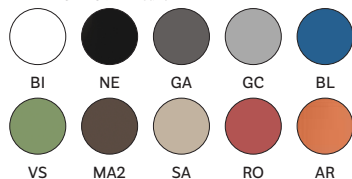

PACKING / Imballo



TECHNICAL DETAILS / Dettagli tecnici



SAFETY, STRENGTH and DURABILITY TESTS
Prove di sicurezza, resistenza e durata
EN 1728:2000

Ara 310/CL1

Fire retardant version
Versione ignifuga



SEAT Sedile	BACK Schienale	FRAME Telaio	POLYPROPYLENE Polipropilene
PPL	PPL	PPL	€ 117,00

Minimum order 300 pcs
Ordine minimo 300 pz

PPL FINISHES / Finiture PPL



PACKING / Imballo



TECHNICAL DETAILS / Dettagli tecnici



SAFETY, STRENGTH and DURABILITY TESTS
Prove di sicurezza, resistenza e durata
EN 1728:2000



Ara 315



SEAT Sedile	BACK Schienale	FRAME Telaio	POLYPROPYLENE Polipropilene
PPL	PPL	PPL	€ 110,00

PPL FINISHES / Finiture PPL

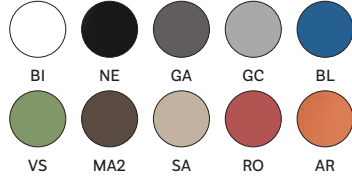

SAFETY, STRENGTH and DURABILITY TESTS
 Prove di sicurezza, resistenza e durata
 EN 1728:2000

PACKING / Imballo



TECHNICAL DETAILS / Dettagli tecnici



Ara 315/CL1

Fire retardant version
 Versione ignifuga



SEAT Sedile	BACK Schienale	FRAME Telaio	POLYPROPYLENE Polipropilene
PPL	PPL	PPL	€ 146,00

Minimum order 300 pcs
 Ordine minimo 300 pz

PPL FINISHES / Finiture PPL



SAFETY, STRENGTH and DURABILITY TESTS
 Prove di sicurezza, resistenza e durata
 EN 1728:2000

PACKING / Imballo



TECHNICAL DETAILS / Dettagli tecnici



Ara 316

LOUNGE



SEAT Sedile	BACK Schienale	FRAME Telaio	POLYPROPYLENE Polipropilene
PPL	PPL	PPL	€ 137,00

PPL FINISHES / Finiture PPL



SAFETY, STRENGTH and DURABILITY TESTS
 Prove di sicurezza, resistenza e durata
 EN 1728:2012+AC2013
 EN 16139:2013 level 2

PACKING / Imballo



TECHNICAL DETAILS / Dettagli tecnici



Arki-Bench ARKB



CODE Codice	TOP Ripiano	FRAME Telaio	BLACK POWDER COATED Verniciato nero	WHITE POWDER COATED Verniciato bianco
ARKB_119X36	119x36FNP_0720 NERO	NERO	€ 487,00	
	119x36CFP_BI BIANCO	BI100		€ 501,00
		BI100E		€ 572,00
ARKB_159X36	159x36FNP_0720 NERO	NERO	€ 566,00	
	159x36CFP_BI BIANCO	BI100		€ 587,00
		BI100E		€ 658,00
ARKB_199X36	199x36FNP_0720 NERO	NERO	€ 615,00	
	199x36CFP_BI BIANCO	BI100		€ 637,00
		BI100E		€ 709,00

SAFETY, STRENGTH and DURABILITY TESTS

Prove di sicurezza, resistenza e durata

EN 1728:2012+AC2013

EN 16139:2013 level 2

TOP FINISHES / Finiture ripiano



FNP* CFP_BI

FRAME FINISHES / Finiture telaio



NERO BI100 BI100E

TECHNICAL DETAILS / Dettagli tecnici

ARKB_119X36

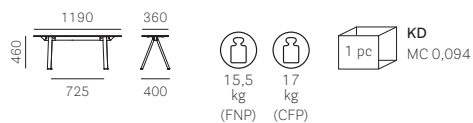

ARKB_159X36



ARKB_199X36

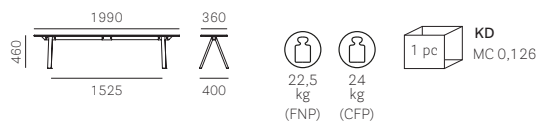

Arki-Bench ARKBW

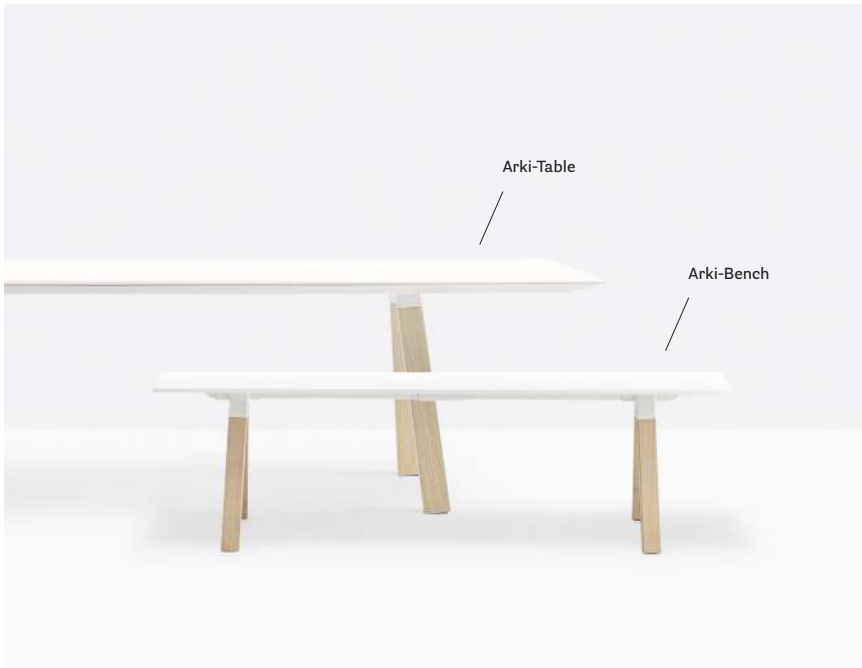

CODE Codice	TOP Ripiano	FRAME Telaio	OAK Rovere
ARKBW_119X36	119x36FNP_0720 NERO	RS	€ 680,00
	119x36CFP_BI BIANCO		€ 695,00
ARKBW_159X36	159x36FNP_0720 NERO	RS	€ 758,00
	159x36CFP_BI BIANCO		€ 780,00
ARKBW_199X36	199x36FNP_0720 NERO	RS	€ 809,00
	199x36CFP_BI BIANCO		€ 830,00

TOP FINISHES / Finiture ripiano



FRAME FINISHES / Finiture telaio



TECHNICAL DETAILS / Dettagli tecnici
ARKBW_119X36



ARKBW_159X36

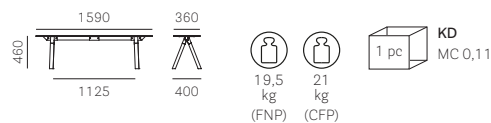

ARKBW_199X36

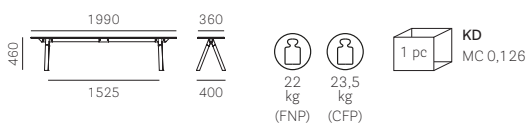



CODE Codice	SEAT Sedile	BACK Schienale	FRAME Telaio	POWDER COATED Verniciato
AS0010 Armchair without armrests Poltrona senza braccioli	D22+D26 D80+D89 D100+D105 D110+D114 D130	D22+D26 D80+D89 D100+D105 D110+D114 D130	Powder coated / Verniciato	€ 2.178,00
AS0111 Armchair with right or left armrest + back cushion Poltrona con bracciolo DX o SX + cuscino schienale	D22+D26 D80+D89 D100+D105 D110+D114 D130	D22+D26 D80+D89 D100+D105 D110+D114 D130	Powder coated / Verniciato	€ 2.665,00
AS0012 Armchair Poltrona con braccioli	D22+D26 D80+D89 D100+D105 D110+D114 D130	D22+D26 D80+D89 D100+D105 D110+D114 D130	Powder coated / Verniciato	€ 2.568,00
AS0020 Sofa without armrests Divano senza braccioli	D22+D26 D80+D89 D100+D105 D110+D114 D130	D22+D26 D80+D89 D100+D105 D110+D114 D130	Powder coated / Verniciato	€ 4.037,00
AS0121 Sofa with right or left armrest + back cushion Divano con bracciolo DX o SX + cuscino schienale	D22+D26 D80+D89 D100+D105 D110+D114 D130	D22+D26 D80+D89 D100+D105 D110+D114 D130	Powder coated / Verniciato	€ 4.524,00
AS0022 Sofa with armrests Divano con braccioli	D22+D26 D80+D89 D100+D105 D110+D114 D130	D22+D26 D80+D89 D100+D105 D110+D114 D130	Powder coated / Verniciato	€ 4.427,00
AS0030 Chaise longue	D22+D26 D80+D89 D100+D105 D110+D114 D130	D22+D26 D80+D89 D100+D105 D110+D114 D130	Powder coated / Verniciato	€ 2.568,00
AS0031 Chaise longue with right or left armrest Chaise longue con bracciolo DX o SX	D22+D26 D80+D89 D100+D105 D110+D114 D130	D22+D26 D80+D89 D100+D105 D110+D114 D130	Powder coated / Verniciato	€ 2.763,00
AS0040 Pouf	D22+D26 D80+D89 D100+D105 D110+D114 D130	D22+D26 D80+D89 D100+D105 D110+D114 D130	Powder coated / Verniciato	€ 1.541,00
AS_LINK	Connecting plate kit for ARKI-SOFA sofas: surcharge € 46,00 Kit lamiera di collegamento per divani ARKI-SOFA: supplemento € 46,00			

TECHNICAL DETAILS / Dettagli tecnici

AS0010

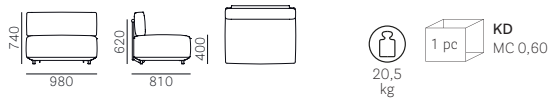

AS0111*

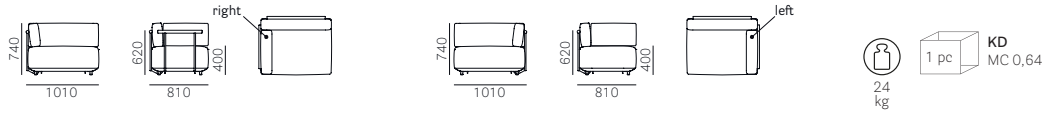

* Only use this element for corner configurations
Modulo da utilizzare esclusivamente per configurazioni angolari

AS0012

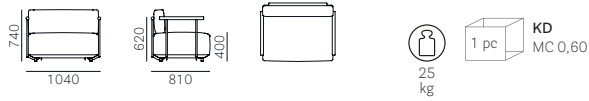

AS0020

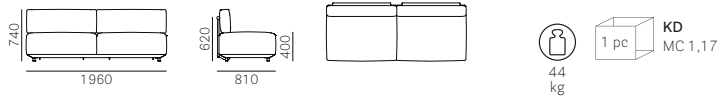

AS0121*

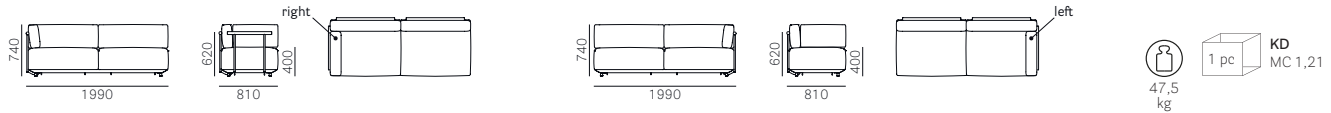

* Only use this element for corner configurations
Modulo da utilizzare esclusivamente per configurazioni angolari

AS0022

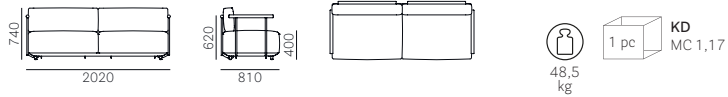

AS0030

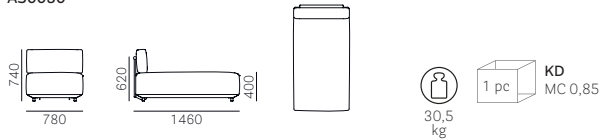

AS0031

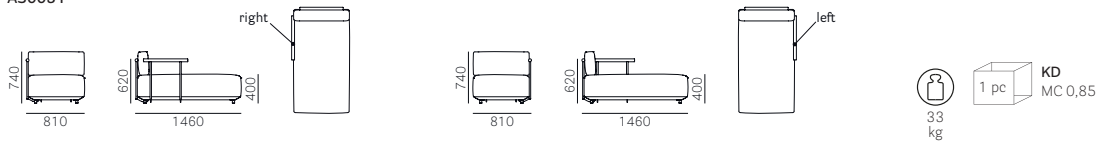

AS0040

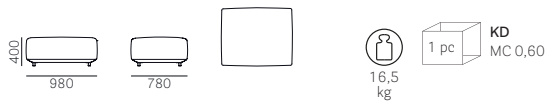

Arki-Stool ARKW6

Gas lift device
Alzata a gas



SEAT Sedile	FRAME Telaio	WHITE POWDER COATED Verniciato bianco	BLACK POWDER COATED Verniciato nero	POWDER COATED Verniciato
RS-AN	650+750	€ 344,00 (RS)	€ 344,00 (AN)	€ 344,00 (RS-AN)

FINISHES / Finiture



RS AN

POWDER COATED FINISHES / Finiture verniciato



BI100 NERO

SAFETY, STRENGTH and DURABILITY TESTS

Prove di sicurezza, resistenza e durata
EN 1728:2012+AC2013
EN 16139:2013 level 2

PACKING / Imballo



TECHNICAL DETAILS / Dettagli tecnici



Arki-Stool ARKW6/2

Gas lift device
Alzata a gas



SEAT Sedile	FRAME Telaio	WHITE POWDER COATED Verniciato bianco	BLACK POWDER COATED Verniciato nero	POWDER COATED Verniciato
C36+C39 C83+C89; C100+C101 C110+C122 C210+C217		€ 444,00	€ 444,00	€ 444,00
D40+D44	710+820	€ 466,00	€ 466,00	€ 466,00
G		€ 494,00	€ 494,00	€ 494,00
Excluding / Escluso H60+H61 H120+H127	G180+G185, G230+G239	€ 452,00	€ 452,00	€ 452,00

For fabrics see page 325
Per i tessuti si veda a p. 325

FINISHES / Finiture

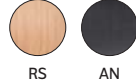

RS AN

POWDER COATED FINISHES / Finiture verniciato



BI100 NERO

SAFETY, STRENGTH and DURABILITY TESTS

Prove di sicurezza, resistenza e durata
EN 1728:2012+AC2013
EN 16139:2013 level 2

PACKING / Imballo



TECHNICAL DETAILS / Dettagli tecnici

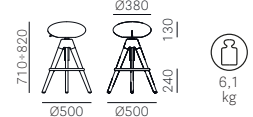

Arki-Stool ARKW8

Gas lift device
Alzata a gas



SEAT Sedile	FRAME Telaio	WHITE POWDER COATED Verniciato bianco	BLACK POWDER COATED Verniciato nero	POWDER COATED Verniciato
RS-AN	550+650	€ 344,00 (RS)	€ 344,00 (AN)	€ 344,00 (RS-AN)

FINISHES / Finiture



RS AN

POWDER COATED FINISHES / Finiture verniciato



BI100 NERO

For colours and finishes see at page 320
Per colori e finiture vedere da pagina 320

PACKING / Imballo



TECHNICAL DETAILS / Dettagli tecnici



Arki-Stool ARKW8/2

Gas lift device
Alzata a gas



SEAT Sedile	FRAME Telaio	WHITE POWDER COATED Verniciato bianco	BLACK POWDER COATED Verniciato nero	POWDER COATED Verniciato
C36+C39 C83+C89; C100+C101 C110+C122 C210+C217		€ 444,00	€ 444,00	€ 444,00
D40+D44	590+700	€ 466,00	€ 466,00	€ 466,00
G		€ 494,00	€ 494,00	€ 494,00
Excluding / Escluso G180+G185, G230+G239				
H60+H61 H120+H127		€ 452,00	€ 452,00	€ 452,00

For fabrics see page 325
Per i tessuti si veda a p. 325

FINISHES / Finiture



POWDER COATED FINISHES / Finiture verniciato



PACKING / Imballo



TECHNICAL DETAILS / Dettagli tecnici

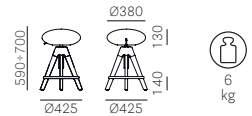

Arod 500



SEAT Sedile	FRAME Telaio	CHROMED Cromato
PC	15x15 H650	€ 253,00
SCR		€ 318,00

PC FINISHES / Finiture PC

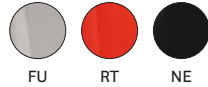

SCR FINISHES / Finiture SCR



PACKING / Imballo



TECHNICAL DETAILS / Dettagli tecnici

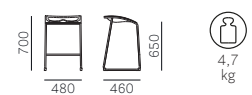

Arod 500



SEAT Sedile	FRAME Telaio	BLACK POWDER COATED Verniciato nero
PC	15x15 H650	€ 253,00

PC FINISHES / Finiture PC



PACKING / Imballo



TECHNICAL DETAILS / Dettagli tecnici

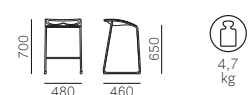

For colours and finishes see at page 320
Per colori e finiture vedere da pagina 320

Arod 510



SEAT Sedile	FRAME Telaio	CHROMED Cromato
PC	15x15 H760	€ 267,00
SCR		€ 332,00

PC FINISHES / Finiture PC

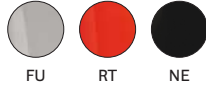

SCR FINISHES / Finiture SCR



SCR

PACKING / Imballo



TECHNICAL DETAILS / Dettagli tecnici

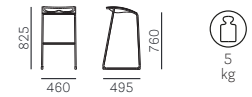

Arod 510



SEAT Sedile	FRAME Telaio	BLACK POWDER COATED Verniciato nero
PC	15x15 H760	€ 267,00

PC FINISHES / Finiture PC



NE

PACKING / Imballo



TECHNICAL DETAILS / Dettagli tecnici

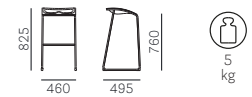

Arod 560



SEAT Sedile	FRAME Telaio	CHROMED Cromato
PC	400x400 H770	€ 351,00
SCR		€ 415,00

PC FINISHES / Finiture PC

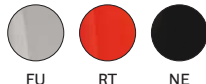

SCR FINISHES / Finiture SCR



SCR

PACKING / Imballo



TECHNICAL DETAILS / Dettagli tecnici

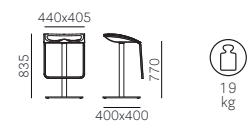

Arod 570

Gas lift device
Alzata a gas



SEAT Sedile	FRAME Telaio	CHROMED Cromato
PC	400x400 H540+800	€ 380,00
SCR		€ 444,00

PC FINISHES / Finiture PC

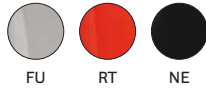

SCR FINISHES / Finiture SCR



SCR

PACKING / Imballo



TECHNICAL DETAILS / Dettagli tecnici

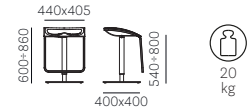

Babila 2730



SEAT Sedile	BACK Schienale	FRAME Telaio	POWDER COATED Verniciato	CHROMED Cromato	OUTDOOR FINISHES Finiture per esterno
BI	BI	Ø 16	€ 111,00	€ 111,00	€ 128,00
SA-GR-NE-GI	SA-GR-NE-GI		€ 119,00	€ 119,00	€ 136,00

TP FINISHES / Finiture TP



PACKING / Imballo



TECHNICAL DETAILS / Dettagli tecnici



SAFETY, STRENGTH and DURABILITY TESTS
Prove di sicurezza, resistenza e durata
EN 1728:2012+AC2013
EN 16139:2013 level 2

Babila 2730/A



SEAT Sedile	BACK Schienale	FRAME Telaio	POWDER COATED Verniciato	CHROMED Cromato
C Excluding / Escluso C36+C39	BI	Ø 16	€ 169,00	€ 169,00
D40+D44			€ 179,00	€ 179,00
E			€ 190,00	€ 190,00
G			€ 190,00	€ 190,00
H Excluding / Escluso H140+H143			€ 171,00	€ 171,00
P			€ 198,00	€ 198,00

For fabrics see page 325
Per i tessuti si veda a p. 325

TP FINISHES / Finiture TP



BI

PACKING / Imballo



TECHNICAL DETAILS / Dettagli tecnici



SAFETY, STRENGTH and DURABILITY TESTS
Prove di sicurezza, resistenza e durata
EN 1728:2012+AC2013
EN 16139:2013 level 2

For colours and finishes see at page 320
Per colori e finiture vedere da pagina 320

Babila 2740



SEAT Sedile	BACK Schienale	FRAME Telaio	POWDER COATED Verniciato	CHROMED Cromato
BI	BI	Ø 10	€ 119,00	€ 119,00
SA-GR-NE-GI	SA-GR-NE-GI		€ 128,00	€ 128,00

TP FINISHES / Finiture TP



PACKING / Imballo



TECHNICAL DETAILS / Dettagli tecnici



Babila 2740/A



SEAT Sedile	BACK Schienale	FRAME Telaio	POWDER COATED Verniciato	CHROMED Cromato
C Excluding / Escluso C36+C39 D40+D44			€ 177,00	€ 177,00
E	BI	Ø 10	€ 186,00	€ 186,00
G			€ 198,00	€ 198,00
H Excluding / Escluso H140+H143			€ 180,00	€ 180,00
P			€ 206,00	€ 206,00

For fabrics see page 325
Per i tessuti si veda a p. 325

TP FINISHES / Finiture TP



PACKING / Imballo



TECHNICAL DETAILS / Dettagli tecnici

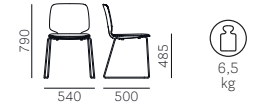

Babila 2750



SEAT Sedile	BACK Schienale	FRAME Telaio	ASH Frassino
BI	BI	FR-N1-AN	€ 181,00
SA-GR-NE-GI	SA-GR-NE-GI		€ 190,00

TP FINISHES / Finiture TP



PACKING / Imballo



TECHNICAL DETAILS / Dettagli tecnici



SAFETY, STRENGTH and DURABILITY TESTS
Prove di sicurezza, resistenza e durata
EN 1728:2012+AC2013
EN 16139:2013 level 2

WOODEN FINISHES / Finiture legno



For colours and finishes see at page 320
Per colori e finiture vedere da pagina 320



PRODUCT CERTIFIED
FOR LOW CHEMICAL
EMISSIONS:
UL.COM/GG
UL 2818

Babila 2750/A



SEAT Sedile	BACK Schienale	FRAME Telaio
C Excluding / Escluso C36+C39 D40+D44		
E	BI	FR-N1-AN
G		
H Excluding / Escluso H140+H143		
P		

ASH
Frassino

For fabrics see page 325
Per i tessuti si veda a p. 325

TP FINISHES / Finiture TP



BI

WOODEN FINISHES / Finiture legno



FR N1 AN

SAFETY, STRENGTH and DURABILITY TESTS
Prove di sicurezza, resistenza e durata
EN 1728:2012+AC2013
EN 16139:2013 level 2

PACKING / Imballo



TECHNICAL DETAILS / Dettagli tecnici



Babila 2700



SEAT Sedile	BACK Schienale	FRAME Telaio
FR-N1-GC- BI-AN	FR-N1-GC- BI-AN	FR-N1-GC- BI-AN

ASH
Frassino

FINISHES / Finiture



FR N1 GC BI AN

SAFETY, STRENGTH and DURABILITY TESTS
Prove di sicurezza, resistenza e durata
EN 1728:2012+AC2013
EN 16139:2013 level 2

PACKING / Imballo



TECHNICAL DETAILS / Dettagli tecnici



PRODUCT CERTIFIED
FOR LOW CHEMICAL
EMISSIONS:
UL.COM/GG
UL 2818

Babila 2700



SEAT Sedile	BACK Schienale	FRAME Telaio
BL2	BL2	BL2
AZ1	AZ1	AZ1
VE2	VE2	VE2
VE1	VE1	VE1
RB	RB	RB
RA	RA	RA
MO	MO	MO
MC	MC	MC

ASH
Frassino

€ 299,00
Lacquered with visible grains
Laccato a poro aperto

FINISHES / Finiture

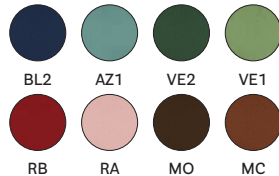

BL2 AZ1 VE2 VE1
RB RA MO MC

SAFETY, STRENGTH and DURABILITY TESTS
Prove di sicurezza, resistenza e durata
EN 1728:2012+AC2013
EN 16139:2013 level 2

PACKING / Imballo



TECHNICAL DETAILS / Dettagli tecnici



PRODUCT CERTIFIED
FOR LOW CHEMICAL
EMISSIONS:
UL.COM/GG
UL 2818

Babila 2700/A



SEAT Sedile	BACK Schienale	FRAME Telaio	ASH Frassino
C Excluding / Escluso C36+C39 D40+D44			€ 341,00
E	FR-N1-GC- BI-AN	FR-N1-GC- BI-AN	€ 350,00
G			€ 362,00
H Excluding / Escluso H140+H143			€ 342,00
P			€ 368,00

For fabrics see page 325
Per i tessuti si veda a p. 325

FINISHES / Finiture



PACKING / Imballo



TECHNICAL DETAILS / Dettagli tecnici



SAFETY, STRENGTH and DURABILITY TESTS
Prove di sicurezza, resistenza e durata
EN 1728:2012+AC2013
EN 16139:2013 level 2



Babila 2710



SEAT Sedile	BACK Schienale	FRAME Telaio	ASH Frassino		
			POWDER COATED Verniciato	CHROMED Cromato	ANTIQU BRASS Ottone anticato
FR-N1-GC- MC-AN	FR-N1-GC- MC-AN	Ø 16	€ 228,00	€ 228,00	€ 322,00

FINISHES / Finiture



PACKING / Imballo



TECHNICAL DETAILS / Dettagli tecnici



Babila 2710/A



SEAT Sedile	BACK Schienale	FRAME Telaio	ASH Frassino		
			POWDER COATED Verniciato	CHROMED Cromato	ANTIQU BRASS Ottone anticato
C Excluding / Escluso C36+C39 D40+D44			€ 289,00	€ 289,00	€ 384,00
E	FR-N1-GC- MC-AN	Ø 16	€ 298,00	€ 298,00	€ 393,00
G			€ 311,00	€ 311,00	€ 406,00
H Excluding / Escluso H140+H143			€ 290,00	€ 290,00	€ 385,00
P			€ 319,00	€ 319,00	€ 414,00

FINISHES / Finiture

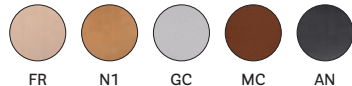

PACKING / Imballo



TECHNICAL DETAILS / Dettagli tecnici



For fabrics see page 325
Per i tessuti si veda a p. 325

For colours and finishes see at page 320
Per colori e finiture vedere da pagina 320



Babila 2720



SEAT Sedile	BACK Schienale	FRAME Telaio	ASH Frassino		
			POWDER COATED Verniciato	CHROMED Cromato	ANTIQU BRASS Ottone anticato
FR-N1-GC-MC-AN	FR-N1-GC-MC-AN	Ø 10	€ 220,00	€ 220,00	€ 314,00

FINISHES / Finiture

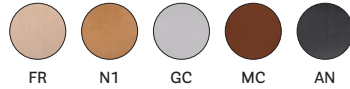

PACKING / Imballo



TECHNICAL DETAILS / Dettagli tecnici



SAFETY, STRENGTH and DURABILITY TESTS
 Prove di sicurezza, resistenza e durata
 EN 1728:2012+AC2013
 EN 16139:2013 level 2



Babila 2720/A



SEAT Sedile	BACK Schienale	FRAME Telaio	ASH Frassino		
			POWDER COATED Verniciato	CHROMED Cromato	ANTIQU BRASS Ottone anticato
C Excluding / Escluso C36+C39 D40+D44	FR-N1-GC-MC-AN	Ø 10	€ 281,00	€ 281,00	€ 376,00
E			€ 303,00	€ 303,00	€ 398,00
G			€ 303,00	€ 303,00	€ 398,00
H Excluding / Escluso H140+H143			€ 283,00	€ 283,00	€ 377,00
P			€ 311,00	€ 311,00	€ 406,00

FINISHES / Finiture

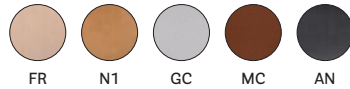

PACKING / Imballo



TECHNICAL DETAILS / Dettagli tecnici



SAFETY, STRENGTH and DURABILITY TESTS
 Prove di sicurezza, resistenza e durata
 EN 1728:2012+AC2013
 EN 16139:2013 level 2



Babila 2731

SOFT



SEAT Sedile	BACK Schienale	FRAME Telaio	ASH Frassino		
			POWDER COATED Verniciato	CHROMED Cromato	ANTIQU BRASS Ottone anticato
C Excluding / Escluso C36+C39, C60+C64 D40+D44	C D40+D44	Ø 16	€ 293,00	€ 293,00	€ 383,00
E	E		€ 328,00	€ 328,00	€ 418,00
G	G		€ 383,00	€ 383,00	€ 472,00
H Excluding / Escluso H140+H143	H		€ 383,00	€ 383,00	€ 472,00
			€ 305,00	€ 305,00	€ 394,00

For fabrics see page 325
 Per i tessuti si veda a p. 325

PACKING / Imballo



TECHNICAL DETAILS / Dettagli tecnici



SAFETY, STRENGTH and DURABILITY TESTS
 Prove di sicurezza, resistenza e durata
 EN 1728:2012+AC2013
 EN 16139:2013 level 2

For colours and finishes see at page 320
 Per colori e finiture vedere da pagina 320

Babila 2741

SOFT



SEAT Sedile	BACK Schienale	FRAME Telaio	POWDER COATED Verniciato	CHROMED Cromato	ANTIQU BRASS Ottone anticato
C Excluding / Escluso C36+C39, C60+C64	C		€ 299,00	€ 299,00	€ 390,00
D40+D44	D40+D44		€ 336,00	€ 336,00	€ 426,00
E	E	Ø 10	€ 390,00	€ 390,00	€ 480,00
G	G		€ 390,00	€ 390,00	€ 480,00
H Excluding / Escluso H140+H143	H		€ 312,00	€ 312,00	€ 402,00

For fabrics see page 325
Per i tessuti si veda a p. 325

PACKING / Imballo



TECHNICAL DETAILS / Dettagli tecnici

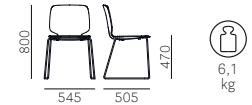

Babila 2751

SOFT



SEAT Sedile	BACK Schienale	FRAME Telaio	ASH Frassino
C Excluding / Escluso C36+C39, C60+C64	C		€ 358,00
D40+D44	D40+D44		€ 393,00
E	E	FR-N1-GC- BI-AN	€ 448,00
G	G		€ 448,00
H Excluding / Escluso H140+H143	H		€ 368,00

For fabrics see page 325
Per i tessuti si veda a p. 325

FINISHES / Finiture

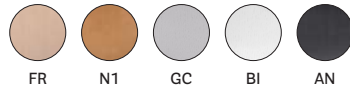

PACKING / Imballo



TECHNICAL DETAILS / Dettagli tecnici



Babila 2735



SEAT Sedile	BACK Schienale	FRAME Telaio	POWDER COATED Verniciato	CHROMED Cromato	OUTDOOR FINISHES Finiture per esterno
PPL	PPL	Ø 16	€ 121,00	€ 121,00	€ 137,00

PPL FINISHES / Finiture PPL



PACKING / Imballo



TECHNICAL DETAILS / Dettagli tecnici

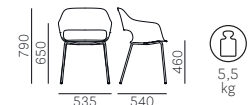

SAFETY, STRENGTH and DURABILITY TESTS
Prove di sicurezza, resistenza e durata
EN 1728:2012+AC2013
EN 16139:2013 level 2

For colours and finishes see at page 320
Per colori e finiture vedere da pagina 320



VAT NOT INCLUDED / Iva esclusa

Babila 2745



SEAT Sedile	BACK Schienale	FRAME Telaio	POWDER COATED Verniciato	CHROMED Cromato
PPL	PPL	Ø 11	€ 129,00	€ 129,00

PPL FINISHES / Finiture PPL



PACKING / Imballo



TECHNICAL DETAILS / Dettagli tecnici

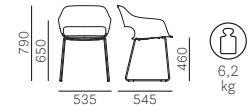

SAFETY, STRENGTH and DURABILITY TESTS
Prove di sicurezza, resistenza e durata
EN 1728:2012+AC2013
EN 16139:2013 level 2



Babila 2755



SEAT Sedile	BACK Schienale	FRAME Telaio	ASH Frassino
PPL	PPL	FR-N1-AN	€ 189,00

PPL FINISHES / Finiture PPL



PACKING / Imballo



TECHNICAL DETAILS / Dettagli tecnici



SAFETY, STRENGTH and DURABILITY TESTS
Prove di sicurezza, resistenza e durata
EN 1728:2012+AC2013
EN 16139:2013 level 2

WOODEN FINISHES / Finiture legno



Babila 2765



SEAT Sedile	BACK Schienale	FRAME Telaio	BRUSHED S/STEEL Inox satinato	POLISHED S/STEEL Inox lucidato
PPL	PPL	Ø 450	€ 284,00	€ 299,00

PPL FINISHES / Finiture PPL



PACKING / Imballo



TECHNICAL DETAILS / Dettagli tecnici

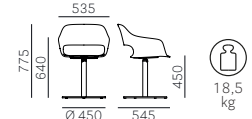

For colours and finishes see at page 320
Per colori e finiture vedere da pagina 320



Babila 2775



SEAT Sedile	BACK Schienale	FRAME Telaio	WHITE/BLACK POWDER COATED Verniciato bianco/nero	POLISHED S/STEEL Inox lucidato
PPL	PPL	Ø 680	€ 237,00	€ 284,00

PPL FINISHES / Finiture PPL



PACKING / Imballo



TECHNICAL DETAILS / Dettagli tecnici

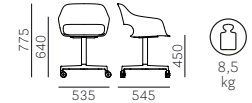

Babila 2736

SOFT



SEAT Sedile	BACK Schienale	FRAME Telaio	POWDER COATED Verniciato	CHROMED Cromato	ANTIQU BRASS Ottone anticato
C Excluding / Escluso C36+C39, C60+C64	C		€ 471,00	€ 471,00	€ 579,00
D40+D44	D40+D44		€ 536,00	€ 536,00	€ 643,00
E	E	Ø 16	€ 663,00	€ 663,00	€ 770,00
G	G		€ 635,00	€ 635,00	€ 741,00
H Excluding / Escluso H140+H143	H		€ 494,00	€ 494,00	€ 601,00

For fabrics see page 325
Per i tessuti si veda a p. 325

PACKING / Imballo



TECHNICAL DETAILS / Dettagli tecnici



SAFETY, STRENGTH and DURABILITY TESTS
Prove di sicurezza, resistenza e durata
EN 1728:2012+AC2013
EN 16139:2013 level 2

Babila 2746

SOFT



SEAT Sedile	BACK Schienale	FRAME Telaio	POWDER COATED Verniciato	CHROMED Cromato	ANTIQU BRASS Ottone anticato
C Excluding / Escluso C36+C39, C60+C64	C		€ 479,00	€ 479,00	€ 585,00
D40+D44	D40+D44		€ 543,00	€ 543,00	€ 650,00
E	E	Ø 11	€ 670,00	€ 670,00	€ 778,00
G	G		€ 641,00	€ 641,00	€ 749,00
H Excluding / Escluso H140+H143	H		€ 501,00	€ 501,00	€ 609,00

For fabrics see page 325
Per i tessuti si veda a p. 325

PACKING / Imballo



TECHNICAL DETAILS / Dettagli tecnici



SAFETY, STRENGTH and DURABILITY TESTS
Prove di sicurezza, resistenza e durata
EN 1728:2012+AC2013
EN 16139:2013 level 2

For colours and finishes see at page 320
Per colori e finiture vedere da pagina 320

Babila 2756

SOFT



SEAT Sedile	BACK Schienale	FRAME Telaio	ASH Frassino
C Excluding / Escluso C36+C39, C60+C64	C		€ 533,00
D40+D44	D40+D44		€ 597,00
E	E	FR-N1-GC- BI-AN	€ 725,00
G	G		€ 696,00
H Excluding / Escluso H140+H143	H		€ 556,00

For fabrics see page 325
Per i tessuti si veda a p. 325

FINISHES / Finiture



PACKING / Imballo



TECHNICAL DETAILS / Dettagli tecnici

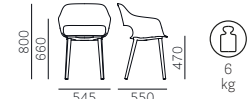

SAFETY, STRENGTH and DURABILITY TESTS
Prove di sicurezza, resistenza e durata
EN 1728:2012+AC2013
EN 16139:2013 level 2



Babila 2766

SOFT



SEAT Sedile	BACK Schienale	FRAME Telaio	BRUSHED S/STEEL Inox satinato	POLISHED S/STEEL Inox lucidato
C Excluding / Escluso C36+C39, C60+C64	C		€ 621,00	€ 635,00
D40+D44	D40+D44		€ 684,00	€ 699,00
E	E	Ø 450	€ 812,00	€ 826,00
G	G		€ 783,00	€ 797,00
H Excluding / Escluso H140+H143	H		€ 643,00	€ 657,00

For fabrics see page 325
Per i tessuti si veda a p. 325

PACKING / Imballo



TECHNICAL DETAILS / Dettagli tecnici

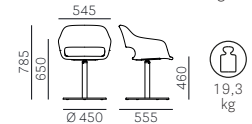

Babila 2776

SOFT



SEAT Sedile	BACK Schienale	FRAME Telaio	WHITE/BLACK POWDER COATED Verniciato bianco/nero	POLISHED S/STEEL Inox lucidato
C Excluding / Escluso C36+C39 C60+C64	C		€ 578,00	€ 621,00
D40+D44	D40+D44		€ 641,00	€ 684,00
E	E	Ø 680	€ 769,00	€ 812,00
G	G		€ 740,00	€ 783,00
H Excluding / Escluso H140+H143	H		€ 600,00	€ 643,00

For fabrics see page 325
Per i tessuti si veda a p. 325

PACKING / Imballo



TECHNICAL DETAILS / Dettagli tecnici



Babila 2703



SEAT Sedile	FRAME Telaio	ASH Frassino
FR-N1-GC-BI-AN	H460	€ 223,00

FINISHES / Finiture

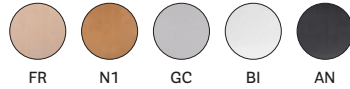

PACKING / Imballo



TECHNICAL DETAILS / Dettagli tecnici



Babila 2703



SEAT Sedile	FRAME Telaio	ASH Frassino
BL2 AZ1 VE2 VE1 RB RA MO MC	H460	€ 237,00 Lacquered with visible grains Laccato a poro aperto

FINISHES / Finiture



PACKING / Imballo



TECHNICAL DETAILS / Dettagli tecnici



Babila 2703/A



SEAT Sedile	FRAME Telaio	ASH Frassino
C Excluding / Escluso C36+C39 D40+D44	H490	€ 294,00
E		€ 303,00
G		€ 314,00
H Excluding / Escluso H140+H143		€ 314,00
P		€ 296,00
		€ 324,00

For fabrics see page 325
Per i tessuti si veda a p. 325

FINISHES / Finiture

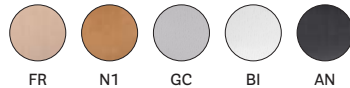

PACKING / Imballo



TECHNICAL DETAILS / Dettagli tecnici



Babila 2702



SEAT Sedile	FRAME Telaio	ASH Frassino			
		POWDER COATED Verniciato	POLISHED ALUMINIUM Alluminio lucidato	SATINIZED Satinato	ANTIQUÉ BRASS Ottone anticato
FR-N1-GC-BI-AN	H650	€ 225,00	€ 268,00	€ 268,00	€ 297,00

FINISHES / Finiture

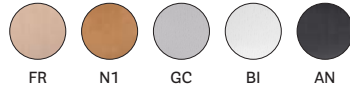

PACKING / Imballo



TECHNICAL DETAILS / Dettagli tecnici



SAFETY, STRENGTH and DURABILITY TESTS
Prove di sicurezza, resistenza e durata
EN 1728:2012+AC2013
EN 16139:2013 level 2



Babila 2702



SEAT Sedile	FRAME Telaio	ASH Frassino				ANTIQUÉ BRASS Ottone anticato
		WHITE POWDER COATED Verniciato bianco	BLACK POWDER COATED Verniciato nero	POLISHED ALUMINIUM Alluminio lucidato	SATINIZED Satinato	
BL2 AZ1* VE2 VE1* RB RA* MO MC	H650	€ 240,00*	€ 240,00	€ 283,00	€ 283,00	€ 311,00

*Die-casted aluminium footrest, white powder coated
Poggiapièdi in pressofusione di alluminio verniciato bianco

FINISHES / Finiture



PACKING / Imballo



TECHNICAL DETAILS / Dettagli tecnici



SAFETY, STRENGTH and DURABILITY TESTS
Prove di sicurezza, resistenza e durata
EN 1728:2012+AC2013
EN 16139:2013 level 2

Lacquered with visible grains
Laccato a poro aperto



Babila 2702/A



SEAT Sedile	FRAME Telaio	ASH Frassino			
		POWDER COATED Verniciato	POLISHED ALUMINIUM Alluminio lucidato	SATINIZED Satinato	ANTIQUÉ BRASS Ottone anticato
C	H680	€ 297,00	€ 340,00	€ 340,00	€ 368,00
Excluding / Escluso C36+C39 D40+D44		€ 306,00	€ 349,00	€ 349,00	€ 377,00
E		€ 318,00	€ 361,00	€ 361,00	€ 389,00
G		€ 318,00	€ 361,00	€ 361,00	€ 389,00
H		€ 298,00	€ 341,00	€ 341,00	€ 370,00
Excluding / Escluso H140+H143 P		€ 327,00	€ 370,00	€ 370,00	€ 398,00

FINISHES / Finiture



PACKING / Imballo



TECHNICAL DETAILS / Dettagli tecnici



SAFETY, STRENGTH and DURABILITY TESTS
Prove di sicurezza, resistenza e durata
EN 1728:2012+AC2013
EN 16139:2013 level 2

For fabrics see page 325
Per i tessuti si veda a p. 325

For colours and finishes see at page 320
Per colori e finiture vedere da pagina 320



Babila 2706



SEAT Sedile	FRAME Telaio	ASH Frassino			
		POWDER COATED Verniciato	POLISHED ALUMINIUM Alluminio lucidato	SATINIZED Satinato	ANTIQUE BRASS Ottone antico
FR-N1-GC-BI-AN	H750	€ 225,00	€ 268,00	€ 268,00	€ 297,00

FINISHES / Finiture



PACKING / Imballo



TECHNICAL DETAILS / Dettagli tecnici



SAFETY, STRENGTH and DURABILITY TESTS
 Prove di sicurezza, resistenza e durata
 EN 1728:2012+AC2013
 EN 16139:2013 level 2



Babila 2706



SEAT Sedile	FRAME Telaio	ASH Frassino				ANTIQUÉ BRASS Ottone antico
		WHITE POWDER COATED Verniciato bianco	BLACK POWDER COATED Verniciato nero	POLISHED ALUMINIUM Alluminio lucidato	SATINIZED Satinato	
BL2 AZ1* VE2 VE1* RB RA* MO MC	H750	€ 240,00*	€ 240,00	€ 283,00	€ 283,00	€ 311,00

Lacquered with visible grains
Laccato a poro aperto

*Die-casted aluminium footrest, white powder coated
 Poggiapièdi in pressofusione di alluminio verniciato bianco

FINISHES / Finiture

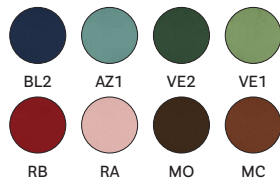

PACKING / Imballo



TECHNICAL DETAILS / Dettagli tecnici



SAFETY, STRENGTH and DURABILITY TESTS
 Prove di sicurezza, resistenza e durata
 EN 1728:2012+AC2013
 EN 16139:2013 level 2



Babila 2706/A



SEAT Sedile	FRAME Telaio	ASH Frassino			
		POWDER COATED Verniciato	POLISHED ALUMINIUM Alluminio lucidato	SATINIZED Satinato	ANTIQUÉ BRASS Ottone antico
C	H780	€ 297,00	€ 340,00	€ 340,00	€ 368,00
Excluding / Escluso C36+C39 D40+D44		€ 306,00	€ 349,00	€ 349,00	€ 377,00
E		€ 318,00	€ 361,00	€ 361,00	€ 389,00
G		€ 318,00	€ 361,00	€ 361,00	€ 389,00
H		€ 298,00	€ 341,00	€ 341,00	€ 370,00
Excluding / Escluso H140+H143 P		€ 327,00	€ 370,00	€ 370,00	€ 398,00

FINISHES / Finiture



PACKING / Imballo



TECHNICAL DETAILS / Dettagli tecnici



SAFETY, STRENGTH and DURABILITY TESTS
 Prove di sicurezza, resistenza e durata
 EN 1728:2012+AC2013
 EN 16139:2013 level 2

For fabrics see page 325
 Per i tessuti si veda a p. 325

For colours and finishes see at page 320
 Per colori e finiture vedere da pagina 320



Babila 2747



SEAT Sedile	BACK Schienale	FRAME Telaio	POWDER COATED Verniciato	CHROMED Cromato	ANTIQU BRASS Ottone antico
PPL	PPL	H645	€ 147,00	€ 156,00	€ 257,00

PPL FINISHES / Finiture PPL



PACKING / Imballo



TECHNICAL DETAILS / Dettagli tecnici

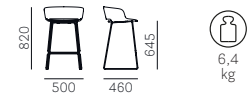

SAFETY, STRENGTH and DURABILITY TESTS
Prove di sicurezza, resistenza e durata
EN 1728:2012+AC2013
EN 16139:2013 level 2



Babila 2748



SEAT Sedile	BACK Schienale	FRAME Telaio	POWDER COATED Verniciato	CHROMED Cromato	ANTIQU BRASS Ottone antico
PPL	PPL	H745	€ 150,00	€ 160,00	€ 266,00

PPL FINISHES / Finiture PPL



PACKING / Imballo



TECHNICAL DETAILS / Dettagli tecnici

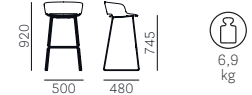

SAFETY, STRENGTH and DURABILITY TESTS
Prove di sicurezza, resistenza e durata
EN 1728:2012+AC2013
EN 16139:2013 level 2



Babila 2757



SEAT Sedile	BACK Schienale	FRAME Telaio	ASH Frassino			ANTIQU BRASS Ottone antico
			POWDER COATED Verniciato	POLISHED ALUMINIUM Alluminio lucidato	SATINIZED Satinato	
PPL	PPL	H645	€ 298,00	€ 363,00	€ 363,00	€ 392,00

PPL FINISHES / Finiture PPL



PACKING / Imballo



TECHNICAL DETAILS / Dettagli tecnici



SAFETY, STRENGTH and DURABILITY TESTS
Prove di sicurezza, resistenza e durata
EN 1728:2012+AC2013
EN 16139:2013 level 2

WOODEN FINISHES / Finiture legno



For colours and finishes see at page 320
Per colori e finiture vedere da pagina 320



Babila 2758



SEAT Sedile	BACK Schienale	FRAME Telaio	ASH Frassino			
			POWDER COATED Verniciato	POLISHED ALUMINIUM Alluminio lucidato	SATINIZED Satinato	ANTIQU BRASS Ottone anticato
PPL	PPL	H745	€ 298,00	€ 363,00	€ 363,00	€ 392,00

PPL FINISHES / Finiture PPL



WOODEN FINISHES / Finiture legno



PACKING / Imballo



TECHNICAL DETAILS / Dettagli tecnici



SAFETY, STRENGTH and DURABILITY TESTS
Prove di sicurezza, resistenza e durata
EN 1728:2012+AC2013
EN 16139:2013 level 2

Babila 2747/2



SEAT Sedile	BACK Schienale	FRAME Telaio	POWDER COATED Verniciato	CHROMED Cromato	ANTIQU BRASS Ottone anticato
C Excluding / Escluso C36+C39, C60+C64	C		€ 446,00	€ 455,00	€ 556,00
D40+D44	D40+D44		€ 489,00	€ 498,00	€ 598,00
E	E	H655	€ 583,00	€ 593,00	€ 693,00
G	G		€ 554,00	€ 565,00	€ 665,00
H Excluding / Escluso H140+H143	H		€ 461,00	€ 470,00	€ 570,00

For fabrics see page 325
Per i tessuti si veda a p. 325

PACKING / Imballo



TECHNICAL DETAILS / Dettagli tecnici



SAFETY, STRENGTH and DURABILITY TESTS
Prove di sicurezza, resistenza e durata
EN 1728:2012+AC2013
EN 16139:2013 level 2

Babila 2748/2



SEAT Sedile	BACK Schienale	FRAME Telaio	POWDER COATED Verniciato	CHROMED Cromato	ANTIQU BRASS Ottone anticato
C Excluding / Escluso C36+C39, C60+C64	C		€ 449,00	€ 458,00	€ 565,00
D40+D44	D40+D44		€ 492,00	€ 501,00	€ 608,00
E	E	H755	€ 585,00	€ 596,00	€ 701,00
G	G		€ 557,00	€ 567,00	€ 673,00
H Excluding / Escluso H140+H143	H		€ 463,00	€ 472,00	€ 579,00

For fabrics see page 325
Per i tessuti si veda a p. 325

PACKING / Imballo



TECHNICAL DETAILS / Dettagli tecnici

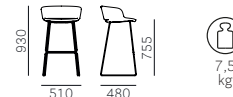

SAFETY, STRENGTH and DURABILITY TESTS
Prove di sicurezza, resistenza e durata
EN 1728:2012+AC2013
EN 16139:2013 level 2

For colours and finishes see at page 320
Per colori e finiture vedere da pagina 320

Babila 2757/2



SEAT Sedile	BACK Schienale	FRAME Telaio	ASH Frassino			
			POWDER COATED Verniciato	POLISHED ALUMINIUM Alluminio lucidato	SATINIZED Satinato	ANTIQU BRASS Ottone anticato
C Excluding / Escluso C36+C39, C60+C64	C D40+D44	H655	€ 597,00	€ 662,00	€ 662,00	€ 691,00
			€ 640,00	€ 705,00	€ 705,00	€ 734,00
E	E		€ 735,00	€ 799,00	€ 799,00	€ 827,00
G	G		€ 706,00	€ 770,00	€ 770,00	€ 799,00
H Excluding / Escluso H140+H143	H		€ 611,00	€ 676,00	€ 676,00	€ 705,00

FINISHES / Finiture

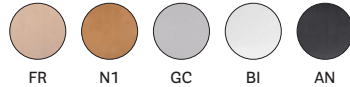

For fabrics see page 325
Per i tessuti si veda a p. 325

PACKING / Imballo



TECHNICAL DETAILS / Dettagli tecnici



SAFETY, STRENGTH and DURABILITY TESTS
Prove di sicurezza, resistenza e durata
EN 1728:2012+AC2013
EN 16139:2013 level 2



Babila 2758/2



SEAT Sedile	BACK Schienale	FRAME Telaio	ASH Frassino			
			POWDER COATED Verniciato	POLISHED ALUMINIUM Alluminio lucidato	SATINIZED Satinato	ANTIQU BRASS Ottone anticato
C Excluding / Escluso C36+C39, C60+C64	C D40+D44	H755	€ 597,00	€ 662,00	€ 662,00	€ 691,00
			€ 640,00	€ 705,00	€ 705,00	€ 734,00
E	E		€ 735,00	€ 799,00	€ 799,00	€ 827,00
G	G		€ 706,00	€ 770,00	€ 770,00	€ 799,00
H Excluding / Escluso H140+H143	H		€ 611,00	€ 676,00	€ 676,00	€ 705,00

FINISHES / Finiture



For fabrics see page 325
Per i tessuti si veda a p. 325

PACKING / Imballo



TECHNICAL DETAILS / Dettagli tecnici



SAFETY, STRENGTH and DURABILITY TESTS
Prove di sicurezza, resistenza e durata
EN 1728:2012+AC2013
EN 16139:2013 level 2



Babila Comfort 2749



SEAT Sedile	BACK Schienale	FRAME Telaio	POWDER COATED Verniciato	CHROMED Cromato	ANTIQU BRASS Ottone anticato	TITANIUM Titanio
C Excluding / Escluso C36+C39, C60+C64, C90+C95	C D40+D44 D120+D123	Ø 12	€ 1.047,00	€ 1.047,00	€ 1.167,00	€ 1.167,00
			€ 1.137,00	€ 1.137,00	€ 1.256,00	€ 1.256,00
E	E		€ 1.388,00	€ 1.388,00	€ 1.507,00	€ 1.507,00
G	G		€ 1.274,00	€ 1.274,00	€ 1.395,00	€ 1.395,00
H Excluding / Escluso H120+H127	H		€ 1.078,00	€ 1.078,00	€ 1.198,00	€ 1.198,00

For fabrics see page 325
Per i tessuti si veda a p. 325

PACKING / Imballo



TECHNICAL DETAILS / Dettagli tecnici

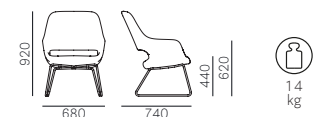

For colours and finishes see at page 320
Per colori e finiture vedere da pagina 320

Babila Comfort 2759



SEAT Sedile	BACK Schienale	FRAME Telaio	ASH Frassino
C Excluding / Escluso D40+D44 D120+D123	C C36+C39, C60+C64, C90+C95 D40+D44 D120+D123		€ 1.144,00
			€ 1.234,00
E	E	FR-N1-GC- BI-AN	€ 1.485,00
G	G		€ 1.372,00
H Excluding / Escluso H120+H127	H		€ 1.176,00

For fabrics see page 325
Per i tessuti si veda a p. 325

FINISHES / Finiture



PACKING / Imballo



TECHNICAL DETAILS / Dettagli tecnici

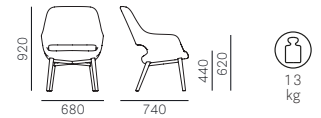

SAFETY, STRENGTH and DURABILITY TESTS
Prove di sicurezza, resistenza e durata
EN 1728:2012+AC2013
EN 16139:2013 level 2



Babila Comfort 2789



SEAT Sedile	BACK Schienale	WHITE/BLACK POWDER COATED Verniciato bianco/nero	POLISHED ALUMINIUM Alluminio lucidato	TITANIUM Titanio
C Excluding / Escluso D40+D44 D120+D123	C C36+C39, C60+C64, C90+C95 D40+D44 D120+D123	€ 1.226,00	€ 1.256,00	€ 1.415,00
		€ 1.317,00	€ 1.347,00	€ 1.505,00
E	E	€ 1.567,00	€ 1.597,00	€ 1.755,00
G	G	€ 1.455,00	€ 1.485,00	€ 1.642,00
H Excluding / Escluso H120+H127	H	€ 1.259,00	€ 1.289,00	€ 1.446,00

For fabrics see page 325
Per i tessuti si veda a p. 325

PACKING / Imballo



TECHNICAL DETAILS / Dettagli tecnici

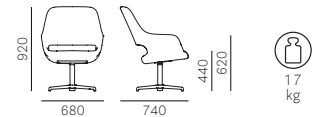

Babila Twist 2795



SEAT Sedile	BACK Schienale	FRAME Telaio	POWDER COATED Verniciato
D22+D26 D80+D89 D100+D105 D110+D114 D130	Ø 16 + Cord/Corda	Ø 20	€ 598,00

For fabrics see page 325
Per i tessuti si veda a p. 325

CORD FINISHES / Finiture corda



PACKING / Imballo



TECHNICAL DETAILS / Dettagli tecnici



For colours and finishes see at page 320
Per colori e finiture vedere da pagina 320

Babila XL 2734R



SEAT Sedile	BACK Schienale	FRAME Telaio	POWDER COATED Verniciato	CHROMED Cromato	OUTDOOR FINISHES Finiture per esterno
PPL	PPL	Ø 16	€ 142,00	€ 142,00	€ 156,00

PPL FINISHES / Finiture PPL



PACKING / Imballo



TECHNICAL DETAILS / Dettagli tecnici

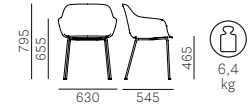

SAFETY, STRENGTH and DURABILITY TESTS
 Prove di sicurezza, resistenza e durata
 EN 1728:2012+AC2013
 EN 16139:2013 level 2

Babila XL 2744R



SEAT Sedile	BACK Schienale	FRAME Telaio	POWDER COATED Verniciato	CHROMED Cromato
PPL	PPL	Ø 11	€ 150,00	€ 150,00

PPL FINISHES / Finiture PPL



PACKING / Imballo



TECHNICAL DETAILS / Dettagli tecnici



SAFETY, STRENGTH and DURABILITY TESTS
 Prove di sicurezza, resistenza e durata
 EN 1728:2012+AC2013
 EN 16139:2013 level 2

Babila XL 2754R



SEAT Sedile	BACK Schienale	FRAME Telaio	ASH Frassino
PPL	PPL	FR-N1-AN	€ 219,00

PPL FINISHES / Finiture PPL



WOODEN FINISHES / Finiture legno



For colours and finishes see at page 320
 Per colori e finiture vedere da pagina 320

PACKING / Imballo



TECHNICAL DETAILS / Dettagli tecnici



SAFETY, STRENGTH and DURABILITY TESTS
 Prove di sicurezza, resistenza e durata
 EN 1728:2012+AC2013
 EN 16139:2013 level 2



Babila XL 2734



SEAT Sedile	BACK Schienale	FRAME Telaio	POWDER COATED Verniciato	CHROMED Cromato	OUTDOOR FINISHES Finiture per esterno
PPL	PPL	Ø 16	€ 142,00	€ 142,00	€ 156,00

PPL FINISHES / Finiture PPL



PACKING / Imballo



TECHNICAL DETAILS / Dettagli tecnici

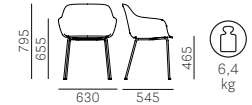

SAFETY, STRENGTH and DURABILITY TESTS
 Prove di sicurezza, resistenza e durata
 EN 1728:2012+AC2013
 EN 16139:2013 level 2

Babila XL 2744



SEAT Sedile	BACK Schienale	FRAME Telaio	POWDER COATED Verniciato	CHROMED Cromato
PPL	PPL	Ø 11	€ 150,00	€ 150,00

PPL FINISHES / Finiture PPL



PACKING / Imballo



TECHNICAL DETAILS / Dettagli tecnici

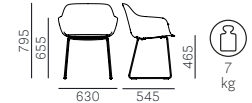

SAFETY, STRENGTH and DURABILITY TESTS
 Prove di sicurezza, resistenza e durata
 EN 1728:2012+AC2013
 EN 16139:2013 level 2

Babila XL 2754



SEAT Sedile	BACK Schienale	FRAME Telaio	ASH Frassino
PPL	PPL	FR-N1-AN	€ 219,00

PPL FINISHES / Finiture PPL



WOODEN FINISHES / Finiture legno



For colours and finishes see at page 320
 Per colori e finiture vedere da pagina 320

PACKING / Imballo



TECHNICAL DETAILS / Dettagli tecnici



SAFETY, STRENGTH and DURABILITY TESTS
 Prove di sicurezza, resistenza e durata
 EN 1728:2012+AC2013
 EN 16139:2013 level 2



Babila XL 2732

SOFT



SEAT Sedile	BACK Schienale	FRAME Telaio	POWDER COATED Verniciato	CHROMED Cromato	GOLD LACQUERED Laccato oro
C83+C89; C100+C101 C110+C122 C210+C217	C83+C89; C100+C101 C110+C122 C210+C217	Ø 16	€ 536,00	€ 536,00	€ 611,00
D40+D44	D40+D44		€ 597,00	€ 597,00	€ 673,00
E	E		€ 693,00	€ 693,00	€ 769,00
G *	G *		€ 693,00	€ 693,00	€ 769,00
H40+H53 H60+H61 H120+H127	H40+H53 H60+H61 H120+H127		€ 557,00	€ 557,00	€ 632,00

*Excluding / Escluso G150+G156, G170+G176; G210+G213

For fabrics see page 325
Per i tessuti si veda a p. 325

PACKING / Imballo



TECHNICAL DETAILS / Dettagli tecnici



SAFETY, STRENGTH and DURABILITY TESTS

Prove di sicurezza, resistenza e durata
EN 1728:2012+AC2013
EN 16139:2013 level 2

Babila XL 2742

SOFT



SEAT Sedile	BACK Schienale	FRAME Telaio	POWDER COATED Verniciato	CHROMED Cromato
C83+C89; C100+C101 C110+C122 C210+C217	C83+C89; C100+C101 C110+C122 C210+C217	Ø 11	€ 544,00	€ 544,00
D40+D44	D40+D44		€ 605,00	€ 605,00
E	E		€ 701,00	€ 701,00
G *	G *		€ 701,00	€ 701,00
H40+H53 H60+H61 H120+H127	H40+H53 H60+H61 H120+H127		€ 565,00	€ 565,00

*Excluding / Escluso G150+G156, G170+G176; G210+G213

For fabrics see page 325
Per i tessuti si veda a p. 325

PACKING / Imballo



TECHNICAL DETAILS / Dettagli tecnici



SAFETY, STRENGTH and DURABILITY TESTS

Prove di sicurezza, resistenza e durata
EN 1728:2012+AC2013
EN 16139:2013 level 2

Babila XL 2752

SOFT



SEAT Sedile	BACK Schienale	FRAME Telaio	ASH Frassino
C83+C89; C100+C101 C110+C122 C210+C217	C83+C89; C100+C101 C110+C122 C210+C217	FR-N1-AN	€ 615,00
D40+D44	D40+D44		€ 676,00
E	E		€ 773,00
G *	G *		€ 773,00
H40+H53 H60+H61 H120+H127	H40+H53 H60+H61 H120+H127		€ 636,00

*Excluding / Escluso G150+G156, G170+G176; G210+G213

FINISHES / Finiture

For fabrics see page 325
Per i tessuti si veda a p. 325

PACKING / Imballo



TECHNICAL DETAILS / Dettagli tecnici



SAFETY, STRENGTH and DURABILITY TESTS

Prove di sicurezza, resistenza e durata
EN 1728:2012+AC2013
EN 16139:2013 level 2For colours and finishes see at page 320
Per colori e finiture vedere da pagina 320

Babila XL 2733R

Armchair with polypropylene shell and removable covering
Poltrona con scocca in polipropilene e imbottitura sfoderabile



SEAT Sedile	BACK Schienale	FRAME Telaio	POWDER COATED Verniciato	CHROMED Cromato	GOLD LACQUERED Laccato oro
C36+C39 C83+C89; C100+C101 C110+C122 C210+C217 D40+D44	C36+C39 C83+C89; C100+C101 C110+C122 C210+C217 D40+D44	Ø 16	€ 476,00	€ 476,00	€ 552,00
E	E		€ 548,00	€ 548,00	€ 623,00
G	G		€ 688,00	€ 688,00	€ 762,00
Excluding / Escluso G100+G102	Excluding / Escluso G100+G102		€ 660,00	€ 660,00	€ 734,00
H40+H53 H60+H61 H120+H127	H40+H53 H60+H61 H120+H127		€ 501,00	€ 501,00	€ 576,00

For fabrics see page 325
Per i tessuti si veda a p. 325

PPL FINISHES / Finiture PPL



RG

SAFETY, STRENGTH and DURABILITY TESTS

Prove di sicurezza, resistenza e durata

EN 1728:2012+AC2013

EN 16139:2013 level 2

PACKING / Imballo



TECHNICAL DETAILS / Dettagli tecnici

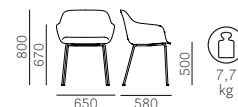

Babila XL 2743R

Armchair with polypropylene shell and removable covering
Poltrona con scocca in polipropilene e imbottitura sfoderabile



SEAT Sedile	BACK Schienale	FRAME Telaio	POWDER COATED Verniciato	CHROMED Cromato
C36+C39 C83+C89; C100+C101 C110+C122 C210+C217 D40+D44	C36+C39 C83+C89; C100+C101 C110+C122 C210+C217 D40+D44	Ø 11	€ 484,00	€ 484,00
E	E		€ 556,00	€ 556,00
G	G		€ 695,00	€ 695,00
Excluding / Escluso G100+G102	Excluding / Escluso G100+G102		€ 666,00	€ 666,00
H40+H53 H60+H61 H120+H127	H40+H53 H60+H61 H120+H127		€ 509,00	€ 509,00

For fabrics see page 325
Per i tessuti si veda a p. 325

PPL FINISHES / Finiture PPL



RG

SAFETY, STRENGTH and DURABILITY TESTS

Prove di sicurezza, resistenza e durata

EN 1728:2012+AC2013

EN 16139:2013 level 2

PACKING / Imballo



TECHNICAL DETAILS / Dettagli tecnici



Babila XL 2753R

Armchair with polypropylene shell and removable covering
Poltrona con scocca in polipropilene e imbottitura sfoderabile



SEAT Sedile	BACK Schienale	FRAME Telaio	ASH Frassino
C36+C39 C83+C89; C100+C101 C110+C122 C210+C217 D40+D44	C36+C39 C83+C89; C100+C101 C110+C122 C210+C217 D40+D44	FR-N1-AN	€ 556,00
E	E		€ 627,00
G	G		€ 767,00
Excluding / Escluso G100+G102	Excluding / Escluso G100+G102		€ 739,00
H40+H53 H60+H61 H120+H127	H40+H53 H60+H61 H120+H127		€ 582,00

For fabrics see page 325
Per i tessuti si veda a p. 325

PPL FINISHES / Finiture PPL



WOODEN FINISHES / Finiture legno



FR

N1

AN

PACKING / Imballo



TECHNICAL DETAILS / Dettagli tecnici



SAFETY, STRENGTH and DURABILITY TESTS

Prove di sicurezza, resistenza e durata

EN 1728:2012+AC2013

EN 16139:2013 level 2

For colours and finishes see at page 320
Per colori e finiture vedere da pagina 320



Babila XL 2734/3

Fabric covering only
Solo vestina



SEAT Sedile	BACK Schienale	FABRIC Tessuto
C36+C39 C83+C89; C100+C101 C110+C122 C210+C217 D40+D44	C36+C39 C83+C89; C100+C101 C110+C122 C210+C217 D40+D44	€ 327,00
E	E	€ 400,00
G	G	€ 539,00
Excluding / Escluso	G100+G102	€ 510,00
H40+H53	H40+H53	€ 353,00
H60+H61	H60+H61	
H120+H127	H120+H127	

For fabrics see page 325
Per i tessuti si veda a p. 325

PACKING / Imballo



TECHNICAL DETAILS / Dettagli tecnici



Blitz 640



SEAT Sedile	BACK Schienale	FRAME Telaio	POLYCARBONATE Policarbonato
PC	PC	PC	€ 156,00

PC FINISHES / Finiture PC

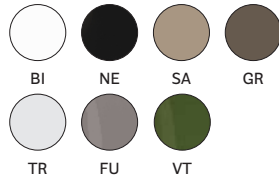

SAFETY, STRENGTH and DURABILITY TESTS
Prove di sicurezza, resistenza e durata
EN 1728:2000

PACKING / Imballo



TECHNICAL DETAILS / Dettagli tecnici



Blitz 640/CL1

Fire retardant version
Versione ignifuga



SEAT Sedile	BACK Schienale	FRAME Telaio	POLYCARBONATE Policarbonato
PC	PC	PC	€ 181,00

Minimum order 300 pcs each colour
Ordine minimo 300 pz per colore

PC FINISHES / Finiture PC



SAFETY, STRENGTH and DURABILITY TESTS
Prove di sicurezza, resistenza e durata
EN 1728:2000

PACKING / Imballo



TECHNICAL DETAILS / Dettagli tecnici



Blitz 640.3

Cushion only
Solo cuscino



SEAT Sedile	FABRIC Tessuto
C	€ 85,00
G	€ 108,00
H Excluding / Escluso H140+H143	€ 86,00

For fabrics see page 325
Per i tessuti si veda a p. 325

PACKING / Imballo



TECHNICAL DETAILS / Dettagli tecnici



Blume 2950



SEAT Sedile	BACK Schienale	FRAME Telaio	ANODIZED ALUMINIUM Alluminio anodizzato			
			BRUSHED BRONZE Bronzo satinato	BRASS Ottone	GREY Grigio	BLACK Nero
C210+C217	C210+C217	Ø 19	€ 779,00	€ 779,00	€ 779,00	€ 779,00
D120+D123	D120+D123		€ 827,00	€ 827,00	€ 827,00	€ 827,00
E	E		€ 900,00	€ 900,00	€ 900,00	€ 900,00
G Excluding / Escluso G100+G102	G		€ 900,00	€ 900,00	€ 900,00	€ 900,00
H Excluding / Escluso H20+H35; H100+H108, H82+H89	H		€ 796,00	€ 796,00	€ 796,00	€ 796,00

For fabrics see page 325
Per i tessuti si veda a p. 325

FINISHES / Finiture

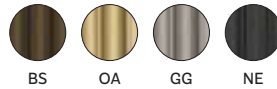

PACKING / Imballo



TECHNICAL DETAILS / Dettagli tecnici



SAFETY, STRENGTH and DURABILITY TESTS
Prove di sicurezza, resistenza e durata
EN 1728:2012+AC2013
EN 16139:2013 level 2

Blume 2951

LOUNGE



SEAT Sedile	BACK Schienale	FRAME Telaio	ANODIZED ALUMINIUM Alluminio anodizzato			
			BRUSHED BRONZE Bronzo satinato	BRASS Ottone	GREY Grigio	BLACK Nero
C210+C217	C210+C217	Ø 19	€ 812,00	€ 812,00	€ 812,00	€ 812,00
D120+D123	D120+D123		€ 862,00	€ 862,00	€ 862,00	€ 862,00
E	E		€ 938,00	€ 938,00	€ 938,00	€ 938,00
G Excluding / Escluso G100+G102	G		€ 938,00	€ 938,00	€ 938,00	€ 938,00
H Excluding / Escluso H20+H35; H100+H108, H82+H89	H		€ 830,00	€ 830,00	€ 830,00	€ 830,00

For fabrics see page 325
Per i tessuti si veda a p. 325

FINISHES / Finiture

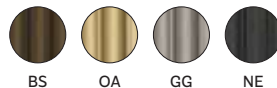

PACKING / Imballo



TECHNICAL DETAILS / Dettagli tecnici

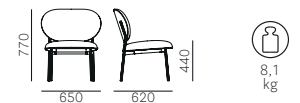

SAFETY, STRENGTH and DURABILITY TESTS
Prove di sicurezza, resistenza e durata
EN 1728:2012+AC2013
EN 16139:2013 level 2

Blume 2955



SEAT Sedile	BACK Schienale	FRAME Telaio	ANODIZED ALUMINIUM Alluminio anodizzato			
			BRUSHED BRONZE Bronzo satinato	BRASS Ottone	GREY Grigio	BLACK Nero
C210+C217	C210+C217	Ø 19	€ 1.004,00	€ 1.004,00	€ 1.004,00	€ 1.004,00
D120+D123	D120+D123		€ 1.052,00	€ 1.052,00	€ 1.052,00	€ 1.052,00
E	E		€ 1.125,00	€ 1.125,00	€ 1.125,00	€ 1.125,00
G Excluding / Escluso G100+G102	G		€ 1.125,00	€ 1.125,00	€ 1.125,00	€ 1.125,00
H Excluding / Escluso H20+H35; H100+H108, H82+H89	H		€ 1.021,00	€ 1.021,00	€ 1.021,00	€ 1.021,00

For fabrics see page 325
Per i tessuti si veda a p. 325

FINISHES / Finiture

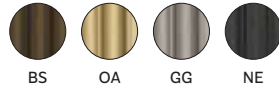

PACKING / Imballo



TECHNICAL DETAILS / Dettagli tecnici



Blume 2959

LOUNGE



SEAT Sedile	BACK Schienale	FRAME Telaio	ANODIZED ALUMINIUM Alluminio anodizzato			
			BRUSHED BRONZE Bronzo satinato	BRASS Ottone	GREY Grigio	BLACK Nero
C210+C217	C210+C217	Ø 19	€ 1.065,00	€ 1.065,00	€ 1.065,00	€ 1.065,00
D120+D123	D120+D123		€ 1.115,00	€ 1.115,00	€ 1.115,00	€ 1.115,00
E	E		€ 1.190,00	€ 1.190,00	€ 1.190,00	€ 1.190,00
G Excluding / Escluso G100+G102	G		€ 1.190,00	€ 1.190,00	€ 1.190,00	€ 1.190,00
H Excluding / Escluso H20+H35; H100+H108, H82+H89	H		€ 1.082,00	€ 1.082,00	€ 1.082,00	€ 1.082,00

For fabrics see page 325
Per i tessuti si veda a p. 325

FINISHES / Finiture

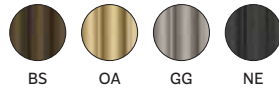

PACKING / Imballo



TECHNICAL DETAILS / Dettagli tecnici

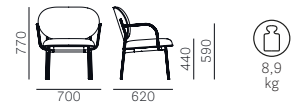

Box 742



SEAT Sedile	BACK Schienale	FRAME Telaio	OAK Rovere
C Excluding / Escluso C36+C39	C	RS-W-N1- GC-BI	€ 481,00
G	G		€ 569,00
H Excluding / Escluso H140+H143	H		€ 487,00
P	P		€ 619,00

For fabrics see page 325
Per i tessuti si veda a p. 325

FINISHES / Finiture



PACKING / Imballo



TECHNICAL DETAILS / Dettagli tecnici

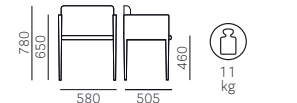

Box 747



SEAT Sedile	BACK Schienale	FRAME Telaio	OAK Rovere
C Excluding / Escluso C36+C39	C	20x20	SATINIZED Satinato
G	G		€ 618,00
H Excluding / Escluso H140+H143	H		€ 719,00
P	P		€ 623,00
			€ 754,00

For fabrics see page 325
Per i tessuti si veda a p. 325

FINISHES / Finiture



PACKING / Imballo



TECHNICAL DETAILS / Dettagli tecnici

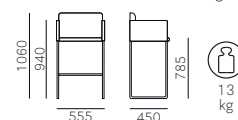

Box 741

LOUNGE



SEAT Sedile	BACK Schienale	FRAME Telaio	OAK Rovere
C Excluding / Escluso C36+C39	C	20x20	SATINIZED Satinato
G	G		€ 644,00
H Excluding / Escluso H140+H143	H		€ 758,00
P	P		€ 644,00
			€ 825,00

For fabrics see page 325
Per i tessuti si veda a p. 325

FINISHES / Finiture



PACKING / Imballo



TECHNICAL DETAILS / Dettagli tecnici

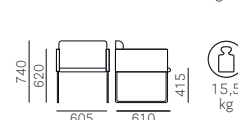

SAFETY, STRENGTH and DURABILITY TESTS
Prove di sicurezza, resistenza e durata
EN 1728:2000

Box 746

SOFA



SEAT Sedile	BACK Schienale	FRAME Telaio	OAK Rovere
C Excluding / Escluso C36+C39	C	20x20	SATINIZED Satinato
G	G		€ 1.070,00
H Excluding / Escluso H140+H143	H		€ 1.273,00
P	P		€ 1.082,00
			€ 1.345,00

For fabrics see page 325
Per i tessuti si veda a p. 325

FINISHES / Finiture



PACKING / Imballo



TECHNICAL DETAILS / Dettagli tecnici

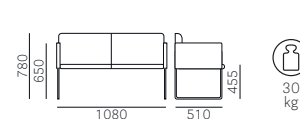

Brera 380



SEAT Sedile	BACK Schienale	FRAME Telaio	OAK Rovere
RS-W-N1- GC-BI	RS-W-N1- GC-BI	RS-W-N1- GC-BI	€ 324,00

FINISHES / Finiture



PACKING / Imballo



TECHNICAL DETAILS / Dettagli tecnici

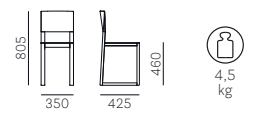

SAFETY, STRENGTH and DURABILITY TESTS
Prove di sicurezza, resistenza e durata
EN 1728:2000



Brera 380



SEAT Sedile	BACK Schienale	FRAME Telaio	OAK Rovere
BL2 AZ1 VE2 VE1 RB RA MO MC	BL2 AZ1 VE2 VE1 RB RA MO MC	BL2 AZ1 VE2 VE1 RB RA MO MC	€ 338,00 Lacquered with visible grains Laccato a poro aperto

FINISHES / Finiture



PACKING / Imballo



TECHNICAL DETAILS / Dettagli tecnici

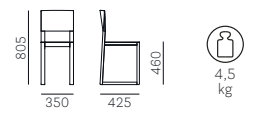

SAFETY, STRENGTH and DURABILITY TESTS
Prove di sicurezza, resistenza e durata
EN 1728:2000



Brera 380



SEAT Sedile	BACK Schienale	FRAME Telaio	OAK Rovere
V101- V102-V103	V101- V102-V103	V101- V102-V103	€ 368,00 Vintage / Anticato

FINISHES / Finiture



PACKING / Imballo



TECHNICAL DETAILS / Dettagli tecnici

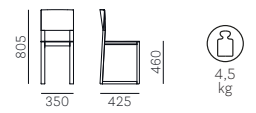

SAFETY, STRENGTH and DURABILITY TESTS
Prove di sicurezza, resistenza e durata
EN 1728:2000



Brera 382



SEAT Sedile	BACK Schienale	FRAME Telaio	OAK Rovere
RS-W-N1- GC-BI	RS-W-N1- GC-BI	H650	€ 394,00

FINISHES / Finiture



PACKING / Imballo



TECHNICAL DETAILS / Dettagli tecnici

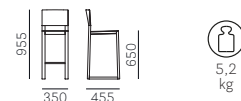

PRODUCT CERTIFIED FOR LOW CHEMICAL EMISSIONS: UL.COM/CGG UL 2818

Brera 382



SEAT Sedile	BACK Schienale	FRAME Telaio	OAK Rovere
BL2 AZ1 VE2 VE1 RB RA MO MC	BL2 AZ1 VE2 VE1 RB RA MO MC	H650	€ 410,00 Lacquered with visible grains Laccato a poro aperto

FINISHES / Finiture

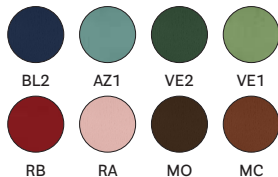

PACKING / Imballo



TECHNICAL DETAILS / Dettagli tecnici

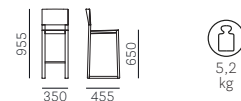

PRODUCT CERTIFIED FOR LOW CHEMICAL EMISSIONS: UL.COM/CGG UL 2818

Brera 382



SEAT Sedile	BACK Schienale	FRAME Telaio	OAK Rovere
V101- V102-V103	V101- V102-V103	H650	€ 440,00 Vintage / Anticato

FINISHES / Finiture



PACKING / Imballo



TECHNICAL DETAILS / Dettagli tecnici

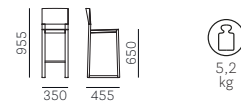

PRODUCT CERTIFIED FOR LOW CHEMICAL EMISSIONS: UL.COM/CGG UL 2818

Brera 386



SEAT Sedile	BACK Schienale	FRAME Telaio	OAK Rovere
RS-W-N1- GC-BI	RS-W-N1- GC-BI	H740	€450,00

FINISHES / Finiture



PACKING / Imballo



TECHNICAL DETAILS / Dettagli tecnici

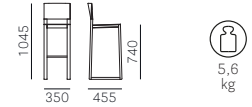

Brera 386



SEAT Sedile	BACK Schienale	FRAME Telaio	OAK Rovere
BL2 AZ1 VE2 VE1 RB RA MO MC	BL2 AZ1 VE2 VE1 RB RA MO MC	H740	€465,00 Lacquered with visible grains Laccato a poro aperto

FINISHES / Finiture



PACKING / Imballo



TECHNICAL DETAILS / Dettagli tecnici

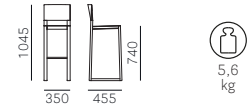

Brera 386



SEAT Sedile	BACK Schienale	FRAME Telaio	OAK Rovere
V101- V102-V103	V101- V102-V103	H740	€496,00 Vintage / Anticato

FINISHES / Finiture



PACKING / Imballo



TECHNICAL DETAILS / Dettagli tecnici

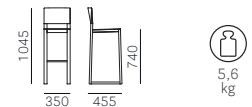

Brera 383

SEAT Sedile	FRAME Telaio	OAK Rovere
RS-W-N1- GC-BI	H460	€ 249,00



FINISHES / Finiture



PACKING / Imballo



TECHNICAL DETAILS / Dettagli tecnici



SAFETY, STRENGTH and DURABILITY TESTS
 Prove di sicurezza, resistenza e durata
 EN 1728:2012+AC2013
 EN 16139:2013 level 2



Brera 383

SEAT Sedile	FRAME Telaio	OAK Rovere
BL2 AZ1 VE2 VE1 RB RA MO MC	H460	€ 264,00 Lacquered with visible grains Laccato a poro aperto



FINISHES / Finiture



PACKING / Imballo



TECHNICAL DETAILS / Dettagli tecnici



SAFETY, STRENGTH and DURABILITY TESTS
 Prove di sicurezza, resistenza e durata
 EN 1728:2012+AC2013
 EN 16139:2013 level 2



Brera 383

SEAT Sedile	FRAME Telaio	OAK Rovere
V101- V102-V103	H460	€ 294,00 Vintage / Anticato



FINISHES / Finiture



PACKING / Imballo



TECHNICAL DETAILS / Dettagli tecnici



SAFETY, STRENGTH and DURABILITY TESTS
 Prove di sicurezza, resistenza e durata
 EN 1728:2012+AC2013
 EN 16139:2013 level 2



Brera 387



SEAT Sedile	FRAME Telaio	OAK Rovere
RS-W-N1- GC-BI	H650	€ 306,00

FINISHES / Finiture



PACKING / Imballo



TECHNICAL DETAILS / Dettagli tecnici



SAFETY, STRENGTH and DURABILITY TESTS
 Prove di sicurezza, resistenza e durata
 EN 1728:2012+AC2013
 EN 16139:2013 level 2



Brera 387



SEAT Sedile	FRAME Telaio	OAK Rovere
BL2 AZ1 VE2 VE1 RB RA MO MC	H650	€ 322,00 Lacquered with visible grains Laccato a poro aperto

FINISHES / Finiture



PACKING / Imballo



TECHNICAL DETAILS / Dettagli tecnici



SAFETY, STRENGTH and DURABILITY TESTS
 Prove di sicurezza, resistenza e durata
 EN 1728:2012+AC2013
 EN 16139:2013 level 2



Brera 387



SEAT Sedile	FRAME Telaio	OAK Rovere
V101- V102-V103	H650	€ 351,00 Vintage / Anticato

FINISHES / Finiture



PACKING / Imballo



TECHNICAL DETAILS / Dettagli tecnici



SAFETY, STRENGTH and DURABILITY TESTS
 Prove di sicurezza, resistenza e durata
 EN 1728:2012+AC2013
 EN 16139:2013 level 2



Brera 388



SEAT Sedile	FRAME Telaio	OAK Rovere
RS-W-N1- GC-BI	H750	€ 306,00

FINISHES / Finiture



PACKING / Imballo



TECHNICAL DETAILS / Dettagli tecnici



SAFETY, STRENGTH and DURABILITY TESTS
 Prove di sicurezza, resistenza e durata
 EN 1728:2012+AC2013
 EN 16139:2013 level 2



Brera 388



SEAT Sedile	FRAME Telaio	OAK Rovere
BL2 AZ1 VE2 VE1 RB RA MO MC	H750	€ 322,00 Lacquered with visible grains Laccato a poro aperto

FINISHES / Finiture



PACKING / Imballo



TECHNICAL DETAILS / Dettagli tecnici



SAFETY, STRENGTH and DURABILITY TESTS
 Prove di sicurezza, resistenza e durata
 EN 1728:2012+AC2013
 EN 16139:2013 level 2



Brera 388



SEAT Sedile	FRAME Telaio	OAK Rovere
V101- V102-V103	H750	€ 351,00 Vintage / Anticato

FINISHES / Finiture



PACKING / Imballo



TECHNICAL DETAILS / Dettagli tecnici

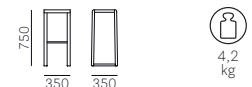

SAFETY, STRENGTH and DURABILITY TESTS
 Prove di sicurezza, resistenza e durata
 EN 1728:2012+AC2013
 EN 16139:2013 level 2



Buddy 210



SEAT Sedile	FRAME Telaio	POWDER COATED Verniciato	ANTIQU BRASS Ottone anticato
C		€ 509,00	€ 595,00
D40÷D44		€ 570,00	€ 656,00
E	550x550	€ 663,00	€ 749,00
G	H400	€ 663,00	€ 749,00
H		€ 530,00	€ 615,00
Excluding / Escluso H140+H143 N01÷N08 N30÷N38		€ 706,00	€ 792,00

For fabrics see page 325
Per i tessuti si veda a p. 325

PACKING / Imballo



TECHNICAL DETAILS / Dettagli tecnici

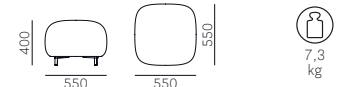

Buddy 211



SEAT Sedile	FRAME Telaio	POWDER COATED Verniciato	ANTIQU BRASS Ottone anticato
C		€ 509,00	€ 595,00
D40÷D44		€ 570,00	€ 656,00
E	550x550	€ 663,00	€ 749,00
G	H450	€ 663,00	€ 749,00
H		€ 530,00	€ 615,00
Excluding / Escluso H140+H143 N01÷N08 N30÷N38		€ 706,00	€ 792,00

For fabrics see page 325
Per i tessuti si veda a p. 325

PACKING / Imballo



TECHNICAL DETAILS / Dettagli tecnici



Buddy 212



SEAT Sedile	FRAME Telaio	POWDER COATED Verniciato	ANTIQU BRASS Ottone anticato
C		€ 822,00	€ 968,00
D40÷D44		€ 947,00	€ 1.092,00
E	900x900	€ 1.139,00	€ 1.285,00
G	H400	€ 1.139,00	€ 1.285,00
H		€ 865,00	€ 1.011,00
Excluding / Escluso H140+H143 N01÷N08 N30÷N38		€ 1.230,00	€ 1.376,00

For fabrics see page 325
Per i tessuti si veda a p. 325

PACKING / Imballo



TECHNICAL DETAILS / Dettagli tecnici

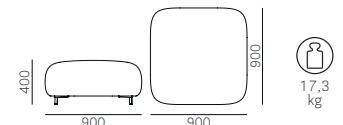

For colours and finishes see at page 320
Per colori e finiture vedere da pagina 320

Buddy 213



SEAT Sedile	FRAME Telaio	POWDER COATED Verniciato	ANTIQU BRASS Ottone anticato
C		€ 822,00	€ 968,00
D40÷D44		€ 947,00	€ 1.092,00
E	900x900	€ 1.139,00	€ 1.285,00
G	H450	€ 1.139,00	€ 1.285,00
H		€ 865,00	€ 1.011,00
Excluding / Escluso H140÷H143 N01÷N08 N30÷N38		€ 1.230,00	€ 1.376,00

For fabrics see page 325
Per i tessuti si veda a p. 325

PACKING / Imballo



TECHNICAL DETAILS / Dettagli tecnici

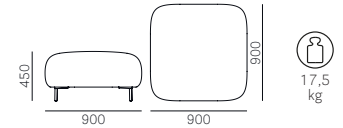

Buddy 214



SEAT Sedile	FRAME Telaio	POWDER COATED Verniciato	ANTIQU BRASS Ottone anticato
C		€ 731,00	€ 877,00
D40÷D44		€ 822,00	€ 968,00
E	1100x550	€ 960,00	€ 1.105,00
G	H400	€ 960,00	€ 1.105,00
H		€ 762,00	€ 908,00
Excluding / Escluso H140÷H143 N01÷N08 N30÷N38		€ 1.025,00	€ 1.170,00

For fabrics see page 325
Per i tessuti si veda a p. 325

PACKING / Imballo



TECHNICAL DETAILS / Dettagli tecnici

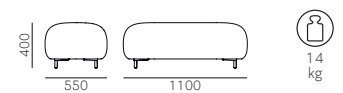

Buddy 215



SEAT Sedile	FRAME Telaio	POWDER COATED Verniciato	ANTIQU BRASS Ottone anticato
C		€ 731,00	€ 877,00
D40÷D44		€ 822,00	€ 968,00
E	1100x550	€ 960,00	€ 1.105,00
G	H450	€ 960,00	€ 1.105,00
H		€ 762,00	€ 908,00
Excluding / Escluso H140÷H143 N01÷N08 N30÷N38		€ 1.025,00	€ 1.170,00

For fabrics see page 325
Per i tessuti si veda a p. 325

PACKING / Imballo



TECHNICAL DETAILS / Dettagli tecnici

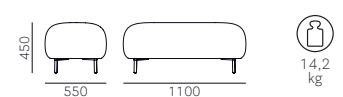

For colours and finishes see at page 320
Per colori e finiture vedere da pagina 320

Buddy 210S

SEAT Sedile	BACK Schienale	FRAME Telaio	POWDER COATED Verniciato	ANTIQU BRASS Ottone anticato
C	C	550x620 H400	€ 920,00	€ 1.050,00
D40÷D44	D40÷D44		€ 1.021,00	€ 1.151,00
E	E		€ 1.176,00	€ 1.306,00
G	G		€ 1.176,00	€ 1.306,00
H Excluding / Escluso H140+H143 N01+N08 N30+N38	H N01+N08 N30+N38		€ 955,00	€ 1.085,00
			€ 1.248,00	€ 1.378,00

For fabrics see page 325
Per i tessuti si veda a p. 325

PACKING / Imballo



TECHNICAL DETAILS / Dettagli tecnici



Buddy 211S

SEAT Sedile	BACK Schienale	FRAME Telaio	POWDER COATED Verniciato	ANTIQU BRASS Ottone anticato
C	C	550x620 H450	€ 920,00	€ 1.050,00
D40÷D44	D40÷D44		€ 1.021,00	€ 1.151,00
E	E		€ 1.176,00	€ 1.306,00
G	G		€ 1.176,00	€ 1.306,00
H Excluding / Escluso H140+H143 N01+N08 N30+N38	H N01+N08 N30+N38		€ 955,00	€ 1.085,00
			€ 1.248,00	€ 1.378,00

For fabrics see page 325
Per i tessuti si veda a p. 325

PACKING / Imballo



TECHNICAL DETAILS / Dettagli tecnici

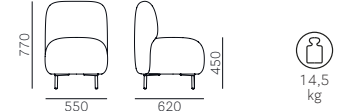

Buddy 212S

SEAT Sedile	BACK Schienale	FRAME Telaio	POWDER COATED Verniciato	ANTIQU BRASS Ottone anticato
C	C	900x970 H400	€ 1.505,00	€ 1.650,00
D40÷D44	D40÷D44		€ 1.716,00	€ 1.862,00
E	E		€ 2.039,00	€ 2.184,00
G	G		€ 2.039,00	€ 2.184,00
H Excluding / Escluso H140+H143 N01+N08 N30+N38	H N01+N08 N30+N38		€ 1.577,00	€ 1.723,00
			€ 2.171,00	€ 2.317,00

For fabrics see page 325
Per i tessuti si veda a p. 325

PACKING / Imballo



TECHNICAL DETAILS / Dettagli tecnici

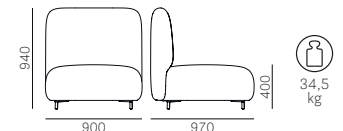

SAFETY, STRENGTH and DURABILITY TESTS
Prove di sicurezza, resistenza e durata
EN 1728:2012+AC2013
EN 16139:2013 level 2

For colours and finishes see at page 320
Per colori e finiture vedere da pagina 320

Buddy 213S



SEAT Sedile	BACK Schienale	FRAME Telaio	POWDER COATED Verniciato	ANTIQUE BRASS Ottone anticato
C	C	900x970 H450	€ 1.505,00	€ 1.650,00
D40÷D44	D40÷D44		€ 1.716,00	€ 1.862,00
E	E		€ 2.039,00	€ 2.184,00
G	G		€ 2.039,00	€ 2.184,00
H Excluding / Escluso H140+H143 N01+N08 N30+N38	H N01+N08 N30+N38		€ 1.577,00	€ 1.723,00
			€ 2.171,00	€ 2.317,00

For fabrics see page 325
Per i tessuti si veda a p. 325

PACKING / Imballo



TECHNICAL DETAILS / Dettagli tecnici

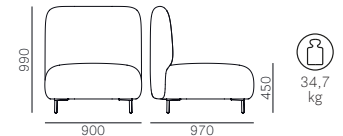

SAFETY, STRENGTH and DURABILITY TESTS
Prove di sicurezza, resistenza e durata
EN 1728:2012+AC2013
EN 16139:2013 level 2

Buddy 214S



SEAT Sedile	BACK Schienale	FRAME Telaio	POWDER COATED Verniciato	ANTIQUE BRASS Ottone anticato
C	C	1100x620 H400	€ 1.454,00	€ 1.649,00
D40÷D44	D40÷D44		€ 1.611,00	€ 1.806,00
E	E		€ 1.853,00	€ 2.048,00
G	G		€ 1.853,00	€ 2.048,00
H Excluding / Escluso H140+H143 N01+N08 N30+N38	H N01+N08 N30+N38		€ 1.508,00	€ 1.703,00
			€ 1.963,00	€ 2.158,00

For fabrics see page 325
Per i tessuti si veda a p. 325

PACKING / Imballo



TECHNICAL DETAILS / Dettagli tecnici

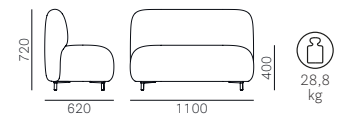

Buddy 215S



SEAT Sedile	BACK Schienale	FRAME Telaio	POWDER COATED Verniciato	ANTIQUE BRASS Ottone anticato
C	C	1100x620 H450	€ 1.454,00	€ 1.649,00
D40÷D44	D40÷D44		€ 1.611,00	€ 1.806,00
E	E		€ 1.853,00	€ 2.048,00
G	G		€ 1.853,00	€ 2.048,00
H Excluding / Escluso H140+H143 N01+N08 N30+N38	H N01+N08 N30+N38		€ 1.508,00	€ 1.703,00
			€ 1.963,00	€ 2.158,00

For fabrics see page 325
Per i tessuti si veda a p. 325

PACKING / Imballo



TECHNICAL DETAILS / Dettagli tecnici

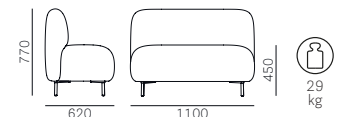

For colours and finishes see at page 320
Per colori e finiture vedere da pagina 320

Buddy 215S/TT

Turning tablet
Tavoletta girevoleTOP
Ripiano

€ 234,00
For item
Per articoli
212, 212S, 213, 213S
214, 214S, 215, 215S

FINISHES / Finiture

Anti-fingerprint finish
Finitura anti-impronta

FNP_NE

PACKING / Imballo

KD
MC 0,031

TECHNICAL DETAILS / Dettagli tecnici

540 325 370 Ø250

3,2
kg

Buddy 212S.3

Cushion only
Solo cuscino

SEAT Sedile	BACK Schienale	FABRIC Tessuto
C	C	€ 163,00
D40÷D44	D40÷D44	€ 190,00
E	E	€ 232,00
G	G	€ 232,00
H	H	€ 173,00
Excluding / Escluso N01÷N08 N30÷N38	H140÷H143 N01÷N08 N30÷N38	€ 251,00

For fabrics see page 325
Per i tessuti si veda a p. 325

PACKING / Imballo

KD
MC 0,096

TECHNICAL DETAILS / Dettagli tecnici

320 640 180 1,2 kg



CODE Codice	SEAT Sedile	BACK Schienale	PANEL Pannello	FRAME Telaio	BLACK POWDER COATED Verniciato nero
BDH001/100 One seat low backrest Un posto schienale basso	D40÷D44	D40÷D44	D40÷D44	Ø 25	€ 3.965,00
	E	E	E		€ 4.439,00
	G	G	G		€ 4.439,00
	H*	H*	H*		€ 3.861,00
BDH001/140 One seat high backrest Un posto schienale alto	D40÷D44	D40÷D44	D40÷D44	Ø 25	€ 4.199,00
	E	E	E		€ 4.790,00
	G	G	G		€ 4.790,00
	H*	H*	H*		€ 4.069,00
BDH001/140_USB One seat with USB socket Un posto con presa USB	D40÷D44	D40÷D44	D40÷D44	Ø 25	€ 4.550,00
	E	E	E		€ 5.141,00
	G	G	G		€ 5.141,00
	H*	H*	H*		€ 4.420,00
BDH001T/140 One seat with turning tablet Un posto con tavoletta girevole	D40÷D44	D40÷D44	D40÷D44	Ø 25	€ 5.275,00
	E	E	E		€ 4.511,00
	G	G	G		€ 5.102,00
	H*	H*	H*		€ 5.102,00
BDH001T/140_USB One seat with turning tablet and USB socket Un posto con tavoletta girevole e presa USB	D40÷D44	D40÷D44	D40÷D44	Ø 25	€ 4.381,00
	E	E	E		€ 5.236,00
	G	G	G		€ 4.862,00
	H*	H*	H*		€ 5.453,00
BDH002/100 Two-seater low backrest Due posti schienale basso	D40÷D44	D40÷D44	D40÷D44	Ø 25	€ 5.453,00
	E	E	E		€ 5.453,00
	G	G	G		€ 4.732,00
	H*	H*	H*		€ 4.732,00
BDH002/140 Two-seater high backrest Due posti schienale alto	D40÷D44	D40÷D44	D40÷D44	Ø 25	€ 5.587,00
	E	E	E		€ 5.164,00
	G	G	G		€ 5.856,00
	H*	H*	H*		€ 5.856,00
BDH002T/140 Two-seater high backrest Due posti schienale alto	D40÷D44	D40÷D44	D40÷D44	Ø 25	€ 5.016,00
	E	E	E		€ 6.004,00
	G	G	G		€ 5.380,00
	H*	H*	H*		€ 6.175,00
BDH002T/140_USB Two-seater high backrest Due posti schienale alto	D40÷D44	D40÷D44	D40÷D44	Ø 25	€ 6.175,00
	E	E	E		€ 6.175,00
	G	G	G		€ 5.203,00
	H*	H*	H*		€ 5.203,00
BDH002T/140_USB Two-seater high backrest Due posti schienale alto	D40÷D44	D40÷D44	D40÷D44	Ø 25	€ 6.354,00
	E	E	E		€ 6.354,00
	G	G	G		€ 6.354,00
	H*	H*	H*		€ 6.354,00

*Excluding / Escluso H82+H89, H20+H35; H100+H108, H140+H143, N20+N27

For fabrics see page 325
Per i tessuti si veda a p. 325

SAFETY, STRENGTH and DURABILITY TESTS
Prove di sicurezza, resistenza e durata
EN 1728:2012+AC2013
EN 16139:2013 level 2
(for BDH001/140 - BDH002/140)

TECHNICAL DETAILS / Dettagli tecnici

BDH001/100

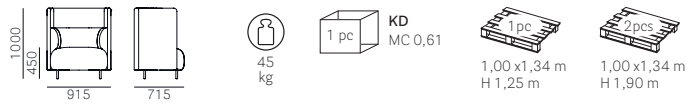

BDH001/140



BDH001/140_USB



BDH001T/140

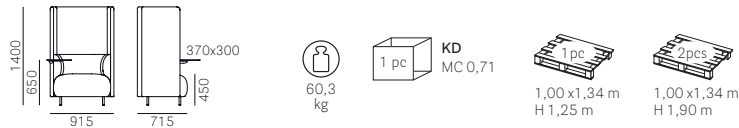

BDH001T/140_USB



BDH002/100

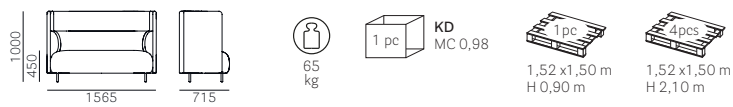

BDH002/140



Do not stack pallets or other packaging
Divieto di sovrapporre bancali o altri imballi

TABLET FINISH / Finitura tavoletta

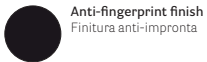

Anti-fingerprint finish
Finitura anti-impronta

FNP_NE



Possibility of adding sockets to connect a charger or install a screen holder
Predisposizione all'elettrificazione per collegare carica batterie o prevedere il fissaggio di un monitor

CODE Codice	SEAT Sedile	BACK Schienale	PANEL Pannello	FRAME Telaio	BLACK POWDER COATED Verniciato nero
BDH011/140 Two-seater box Box a due posti	D40÷D44	D40÷D44	D40÷D44		€ 8.885,00
	E	E	E		€ 10.185,00
	G	G	G	Ø 25	€ 10.185,00
	H*	H*	H*		€ 8.599,00
	N*	N*	N*		€ 10.465,00
BDH011M/140 Two-seater box with shelf Box a due posti con mensola	D40÷D44	D40÷D44	D40÷D44		€ 9.111,00
	E	E	E		€ 10.413,00
	G	G	G	Ø 25	€ 10.413,00
	H*	H*	H*		€ 8.825,00
	N*	N*	N*		€ 10.694,00
BDH011P/140 Two-seater box with table Box a due posti con tavolo a penisola	D40÷D44	D40÷D44	D40÷D44		€ 9.306,00
	E	E	E		€ 10.608,00
	G	G	G	Ø 25	€ 10.608,00
	H*	H*	H*		€ 9.020,00
	N*	N*	N*		€ 10.889,00
BDH011P/140_CCO Two-seater box with table and cable management Box a due posti con tavolo a penisola e canalina	D40÷D44	D40÷D44	D40÷D44		€ 9.423,00
	E	E	E		€ 10.725,00
	G	G	G	Ø 25	€ 10.725,00
	H*	H*	H*		€ 9.137,00
	N*	N*	N*		€ 11.006,00
BDH022/140 Four-seater box Box a quattro posti	D40÷D44	D40÷D44	D40÷D44		€ 11.167,00
	E	E	E		€ 12.878,00
	G	G	G	Ø 25	€ 12.878,00
	H*	H*	H*		€ 10.788,00
	N*	N*	N*		€ 13.253,00
BDH022M/140 Four-seater box with shelf Box a quattro posti con mensola	D40÷D44	D40÷D44	D40÷D44		€ 11.394,00
	E	E	E		€ 13.107,00
	G	G	G	Ø 25	€ 13.107,00
	H*	H*	H*		€ 11.014,00
	N*	N*	N*		€ 13.481,00
BDH022P/140 Four-seater box with table Box a quattro posti con tavolo a penisola	D40÷D44	D40÷D44	D40÷D44		€ 11.758,00
	E	E	E		€ 13.471,00
	G	G	G	Ø 25	€ 13.471,00
	H*	H*	H*		€ 11.378,00
	N*	N*	N*		€ 13.845,00
BDH022P/140_CCO Four-seater box with table and cable management Box a quattro posti con tavolo a penisola e canalina	D40÷D44	D40÷D44	D40÷D44		€ 11.875,00
	E	E	E		€ 13.588,00
	G	G	G	Ø 25	€ 13.588,00
	H*	H*	H*		€ 11.495,00
	N*	N*	N*		€ 13.962,00

*Excluding / Escluso H82+H89, H20+H35; H100+H108, H140+H143, N20+N27

For fabrics see page 325
Per i tessuti si veda a p. 325

TECHNICAL DETAILS / Dettagli tecnici

BDH011/140

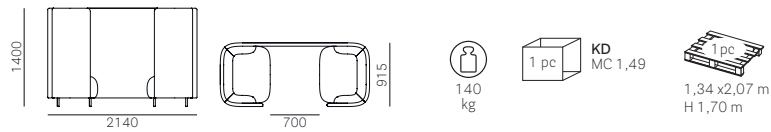

BDH011M/140

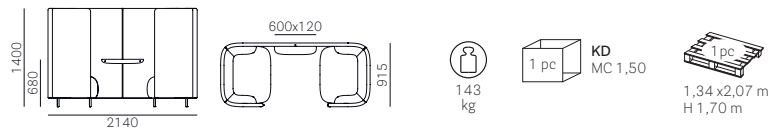

BDH011P/140

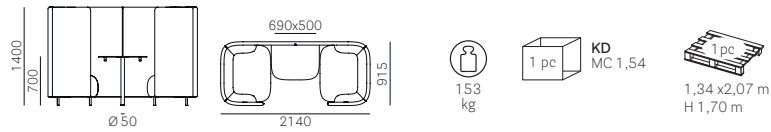

BDH011P/140_CCO

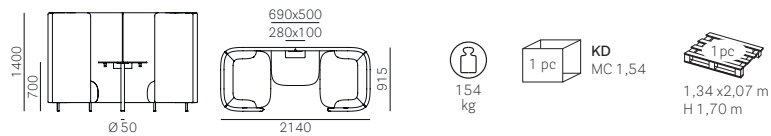

BDH022/140

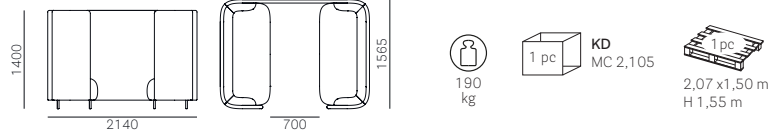

BDH022M/140

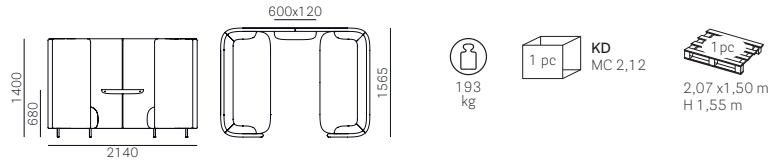

BDH022P/140

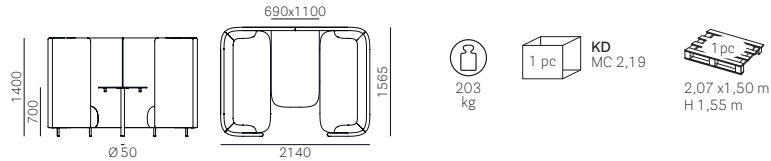

BDH022P/140_CCO

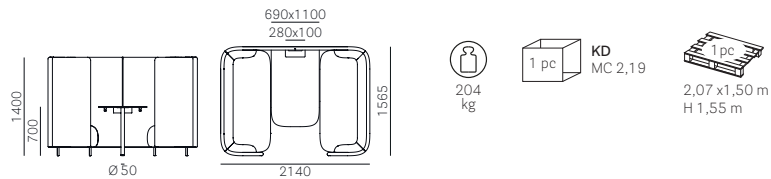

Do not stack pallets or other packaging
Divieto di sovrapporre bancali o altri imballi

STEEL SHELF FINISH
Finitura mensola in lamiera



NERO

TABLE TOP FINISH
Finitura ripiano tavolo a penisola



FNP_NE

Anti-fingerprint finish
Finitura anti-impronta

Buddy Sofa

Fabric version
Versione in tessuto

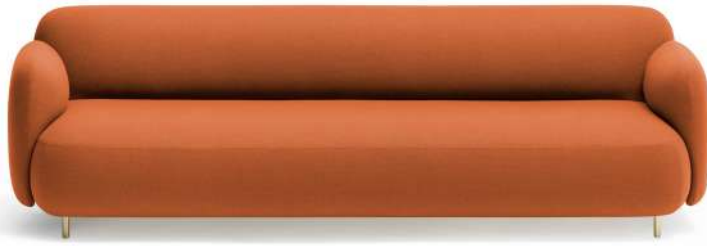

Stitching for fabric version
Cuciture versione in tessuto

CODE Codice	SEAT Sedile	BACK Schienale	FRAME Telaio	POWDER COATED Verniciato	ANTIQUE BRASS Ottone anticato
With armrests / Con braccioli					
218 Two seater sofa Divano a due posti	E	E	Ø 25	€ 4.355,00	€ 4.355,00
	G	G		€ 4.085,00	€ 4.085,00
	H40+H53 H60+H61 H120+H127 H140+H143	H40+H53 H60+H61 H120+H127 H140+H143		€ 3.500,00	€ 3.500,00
	N01+N08 N30+N38	N01+N08 N30+N38		€ 4.296,00	€ 4.296,00
219 Three seater sofa Divano a tre posti	E	E	Ø 25	€ 5.151,00	€ 5.151,00
	G	G		€ 4.836,00	€ 4.836,00
	H40+H53 H60+H61 H120+H127 H140+H143	H40+H53 H60+H61 H120+H127 H140+H143		€ 4.190,00	€ 4.190,00
	N01+N08 N30+N38	N01+N08 N30+N38		€ 5.061,00	€ 5.061,00
Without armrests / Senza braccioli					
218/2 Two seater sofa Divano a due posti	E	E	Ø 25	€ 3.184,00	€ 3.184,00
	G	G		€ 3.003,00	€ 3.003,00
	H40+H53 H60+H61 H120+H127 H140+H143	H40+H53 H60+H61 H120+H127 H140+H143		€ 2.584,00	€ 2.584,00
	N01+N08 N30+N38	N01+N08 N30+N38		€ 3.154,00	€ 3.154,00
219/2 Three seater sofa Divano a tre posti	E	E	Ø 25	€ 3.980,00	€ 3.980,00
	G	G		€ 3.755,00	€ 3.755,00
	H40+H53 H60+H61 H120+H127 H140+H143	H40+H53 H60+H61 H120+H127 H140+H143		€ 3.274,00	€ 3.274,00
	N01+N08 N30+N38	N01+N08 N30+N38		€ 3.920,00	€ 3.920,00

SAFETY, STRENGTH and DURABILITY TESTS

Prove di sicurezza, resistenza e durata

EN 1728:2012+AC2013

EN 16139:2013 level 2

For fabrics see page 325
Per i tessuti si veda a p. 325

For colours and finishes see at page 320
Per colori e finiture vedere da pagina 320

TECHNICAL DETAILS / Dettagli tecnici

218

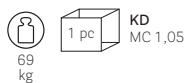

219

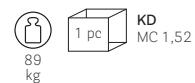
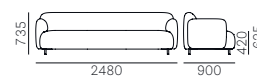

218/2



219/2

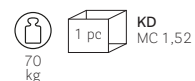
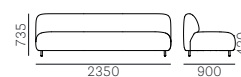

Buddy Sofa

Leather version
Versione in pelleStitching for simil leather and leather version
Cuciture versione in finta e vera pelle

CODE Codice	SEAT Sedile	BACK Schienale	FRAME Telaio	POWDER COATED Verniciato	ANTIQUÉ BRASS Ottone anticato	
With armrests / Con braccioli	C130+C141	C130+C141	Ø 25	€ 3.560,00	€ 3.560,00	
	218 Two seater sofa Divano a due posti	H20+H35; H100+H108		H20+H35; H100+H108	€ 3.650,00	€ 3.650,00
	P	P		€ 4.940,00	€ 4.940,00	
219 Three seater sofa Divano a tre posti	C130+C141	C130+C141	Ø 25	€ 4.220,00	€ 4.220,00	
	H20+H35; H100+H108	H20+H35; H100+H108		€ 4.340,00	€ 4.340,00	
	P	P		€ 6.006,00	€ 6.006,00	
Without armrests / Senza braccioli	C130+C141	C130+C141	Ø 25	€ 2.673,00	€ 2.673,00	
	218/2 Two seater sofa Divano a due posti	H20+H35; H100+H108		H20+H35; H100+H108	€ 2.734,00	€ 2.734,00
	P	P		€ 3.635,00	€ 3.635,00	
219/2 Three seater sofa Divano a tre posti	C130+C141	C130+C141	Ø 25	€ 3.335,00	€ 3.335,00	
	H20+H35; H100+H108	H20+H35; H100+H108		€ 3.425,00	€ 3.425,00	
	P	P		€ 4.701,00	€ 4.701,00	

SAFETY, STRENGTH and DURABILITY TESTS

Prove di sicurezza, resistenza e durata

EN 1728:2012+AC2013

EN 16139:2013 level 2

TECHNICAL DETAILS / Dettagli tecnici

218

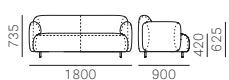

218/2

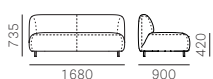

For fabrics see page 325

Per i tessuti si veda a p. 325

For colours and finishes see at page 320

Per colori e finiture vedere da pagina 320

219

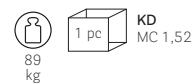
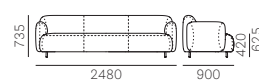

219/2

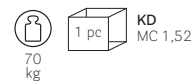

Cube 1400



SEAT Sedile	FRAME Telaio	WHITE/BLACK POWDER COATED Verniciato bianco/nero
PNE, PBI	25x25	€ 272,00

FINISHES / Finiture



PACKING / Imballo



TECHNICAL DETAILS / Dettagli tecnici



Cube 1401



SEAT Sedile	FRAME Telaio	CHROMED Cromato	SATINIZED Satinato	CORTEN Effetto Corten	ANTIQU BRASS/COPPER Ottone/rame anticato
C Excluding / Escluso C36+C39	25x25	€ 227,00	€ 263,00	€ 263,00	€ 314,00
G		€ 271,00	€ 307,00	€ 307,00	€ 358,00
H Excluding / Escluso H140+H143		€ 225,00	€ 262,00	€ 262,00	€ 312,00
P		€ 289,00	€ 325,00	€ 325,00	€ 376,00

For fabrics see page 325
Per i tessuti si veda a p. 325

PACKING / Imballo



TECHNICAL DETAILS / Dettagli tecnici



Cube 1401/RV



SEAT Sedile	FRAME Telaio	CHROMED Cromato	SATINIZED Satinato
RS-W	25x25	€ 185,00	€ 221,00

FINISHES / Finiture



PACKING / Imballo



TECHNICAL DETAILS / Dettagli tecnici



Cube 1402



SEAT Sedile	FRAME Telaio	WHITE/BLACK POWDER COATED Verniciato bianco/nero
PNE, PBI	25x25	€ 253,00

FINISHES / Finiture



PACKING / Imballo



TECHNICAL DETAILS / Dettagli tecnici



Cube 1402



SEAT Sedile	FRAME Telaio	CHROMED Cromato	SATINIZED Satinato	CORTEN Effetto Corten	ANTIQU BRASS/COPPER Ottone/rame anticato
C Excluding / Escluso C36+C39	25x25	€ 223,00	€ 262,00	€ 262,00	€ 310,00
G		€ 267,00	€ 306,00	€ 306,00	€ 354,00
H Excluding / Escluso H140+H143		€ 221,00	€ 260,00	€ 260,00	€ 309,00
P		€ 285,00	€ 324,00	€ 324,00	€ 372,00

For fabrics see page 325
Per i tessuti si veda a p. 325

PACKING / Imballo



TECHNICAL DETAILS / Dettagli tecnici



Cube 1402/RV



SEAT Sedile	FRAME Telaio	CHROMED Cromato	SATINIZED Satinato
RS-W	25x25	€ 181,00	€ 212,00

FINISHES / Finiture



PACKING / Imballo



TECHNICAL DETAILS / Dettagli tecnici



Cube 1403



SEAT Sedile	FRAME Telaio	WHITE/BLACK POWDER COATED Verniciato bianco/nero
PNE, PBI	25x25	€ 249,00

FINISHES / Finiture



PACKING / Imballo



TECHNICAL DETAILS / Dettagli tecnici



Cube 1403



SEAT Sedile	FRAME Telaio	CHROMED Cromato	SATINIZED Satinato	CORTEN Effetto Corten	ANTIQU BRASS/COPPER Ottone/rame anticato
C Excluding / Escluso C36+C39	25x25	€ 220,00	€ 258,00	€ 258,00	€ 306,00
G		€ 264,00	€ 302,00	€ 302,00	€ 350,00
H Excluding / Escluso H140+H143		€ 219,00	€ 257,00	€ 257,00	€ 305,00
P		€ 283,00	€ 320,00	€ 320,00	€ 368,00

For fabrics see page 325
Per i tessuti si veda a p. 325

PACKING / Imballo



TECHNICAL DETAILS / Dettagli tecnici



Cube 1403/RV



SEAT Sedile	FRAME Telaio	CHROMED Cromato	SATINIZED Satinato
RS-W	25x25	€ 179,00	€ 207,00

FINISHES / Finiture



PACKING / Imballo



TECHNICAL DETAILS / Dettagli tecnici



Cube XL 1451



SEAT Sedile	FRAME Telaio	CHROMED Cromato	SATINIZED Satinato
C Excluding / Escluso C36+C39	25x25	€ 242,00	€ 310,00
G		€ 299,00	€ 367,00
H Excluding / Escluso H140+H143		€ 246,00	€ 314,00
P		€ 314,00	€ 381,00

For fabrics see page 325
Per i tessuti si veda a p. 325

PACKING / Imballo



TECHNICAL DETAILS / Dettagli tecnici



Cube XL 1453



SEAT Sedile	FRAME Telaio	CHROMED Cromato	SATINIZED Satinato
C Excluding / Escluso C36+C39	25x25	€ 238,00	€ 306,00
G		€ 296,00	€ 363,00
H Excluding / Escluso H140+H143		€ 242,00	€ 310,00
P		€ 310,00	€ 377,00

For fabrics see page 325
Per i tessuti si veda a p. 325

PACKING / Imballo



TECHNICAL DETAILS / Dettagli tecnici



Cube XL 1461



SEAT Sedile	BACK Schienale	FRAME Telaio	BLACK POWDER COATED Verniciato nero	POWDER COATED Verniciato	CHROMED Cromato	SATINIZED Satinato
C Excluding / Escluso C36+C39	C	25x25	€ 384,00	€ 392,00	€ 446,00	€ 492,00
G	G		€ 484,00	€ 493,00	€ 546,00	€ 592,00
H Excluding / Escluso H140+H143	H		€ 390,00	€ 398,00	€ 453,00	€ 498,00
P	P		€ 519,00	€ 528,00	€ 582,00	€ 627,00

For fabrics see page 325
Per i tessuti si veda a p. 325

PACKING / Imballo

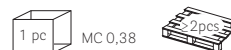

TECHNICAL DETAILS / Dettagli tecnici

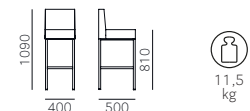

For colours and finishes see at page 320
Per colori e finiture vedere da pagina 320

Dome 260



SEAT Sedile	BACK Schienale	FRAME Telaio	POLYPROPYLENE Polipropilene
PPL	PPL	PPL	€ 78,00

PPL FINISHES / Finiture PPL



SAFETY, STRENGTH and DURABILITY TESTS
 Prove di sicurezza, resistenza e durata
 EN 1728:2012+AC2013
 EN 16139:2013 level 2

PACKING / Imballo



TECHNICAL DETAILS / Dettagli tecnici



PRODUCT CERTIFIED
 FOR LOW CHEMICAL
 EMISSIONS:
 UL.COM/GG
 UL 2818

Dome 260/CL1

Fire retardant version
 Versione ignifuga



SEAT Sedile	BACK Schienale	FRAME Telaio	POLYPROPYLENE Polipropilene
PPL	PPL	PPL	€ 121,00

Minimum order 300 pcs
 Ordine minimo 300 pz

PPL FINISHES / Finiture PPL



SAFETY, STRENGTH and DURABILITY TESTS
 Prove di sicurezza, resistenza e durata
 EN 1728:2012+AC2013
 EN 16139:2013 level 2

PACKING / Imballo



TECHNICAL DETAILS / Dettagli tecnici



Dome 261

Perforated
 Forata



SEAT Sedile	BACK Schienale	FRAME Telaio	POLYPROPYLENE Polipropilene
PPL	PPL	PPL	€ 78,00

PPL FINISHES / Finiture PPL

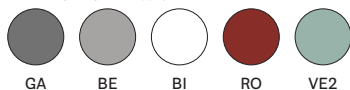

PACKING / Imballo



TECHNICAL DETAILS / Dettagli tecnici



PRODUCT CERTIFIED
 FOR LOW CHEMICAL
 EMISSIONS:
 UL.COM/GG
 UL 2818

Dome 265



SEAT Sedile	BACK Schienale	FRAME Telaio	POLYPROPYLENE Polipropilene
PPL	PPL	PPL	€ 93,00

PPL FINISHES / Finiture PPL



SAFETY, STRENGTH and DURABILITY TESTS
 Prove di sicurezza, resistenza e durata
 EN 1728:2012+AC2013
 EN 16139:2013 level 2

PACKING / Imballo



TECHNICAL DETAILS / Dettagli tecnici

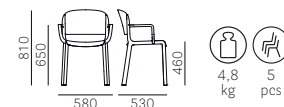

PRODUCT CERTIFIED
 FOR LOW CHEMICAL
 EMISSIONS:
 UL.COM/CGG
 UL 2818

Dome 265/CL1

Fire retardant version
 Versione ignifuga



SEAT Sedile	BACK Schienale	FRAME Telaio	POLYPROPYLENE Polipropilene
PPL	PPL	PPL	€ 140,00

Minimum order 300 pcs
 Ordine minimo 300 pz

PPL FINISHES / Finiture PPL



SAFETY, STRENGTH and DURABILITY TESTS
 Prove di sicurezza, resistenza e durata
 EN 1728:2012+AC2013
 EN 16139:2013 level 2

PACKING / Imballo



TECHNICAL DETAILS / Dettagli tecnici

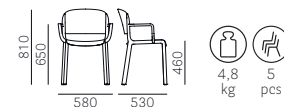

Dome 266

Perforated
 Forata



SEAT Sedile	BACK Schienale	FRAME Telaio	POLYPROPYLENE Polipropilene
PPL	PPL	PPL	€ 93,00

PPL FINISHES / Finiture PPL

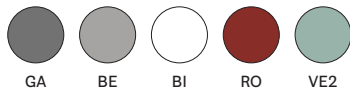

PACKING / Imballo



TECHNICAL DETAILS / Dettagli tecnici

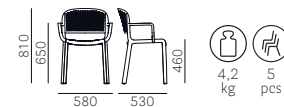

PRODUCT CERTIFIED
 FOR LOW CHEMICAL
 EMISSIONS:
 UL.COM/CGG
 UL 2818

Dome 267



SEAT Sedile	FRAME Telaio	POLYPROPYLENE Polipropilene
PPL	PPL H650	€ 103,00

PPL FINISHES / Finiture PPL



SAFETY, STRENGTH and DURABILITY TESTS
Prove di sicurezza, resistenza e durata
EN 1728:2012+AC2013
EN 16139:2013 level 2

PACKING / Imballo



TECHNICAL DETAILS / Dettagli tecnici



Dome 268



SEAT Sedile	FRAME Telaio	POLYPROPYLENE Polipropilene
PPL	PPL H760	€ 104,00

PPL FINISHES / Finiture PPL

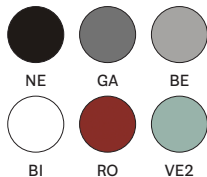

SAFETY, STRENGTH and DURABILITY TESTS
Prove di sicurezza, resistenza e durata
EN 1728:2012+AC2013
EN 16139:2013 level 2

PACKING / Imballo



TECHNICAL DETAILS / Dettagli tecnici

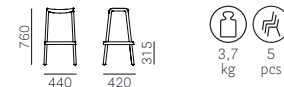

Dress 530



SEAT Sedile	BACK Schienale	FRAME Telaio	OAK Rovere
C Excluding / Escluso C36+C39	C	RS-W-N1- GC-BI	€ 420,00
E	E		€ 576,00
G	G		€ 576,00
H Excluding / Escluso H140+H143	H		€ 436,00
P	P		€ 624,00

For fabrics see page 325
Per i tessuti si veda a p. 325

FINISHES / Finiture



SAFETY, STRENGTH and DURABILITY TESTS
Prove di sicurezza, resistenza e durata
EN 1728:2000

PACKING / Imballo



TECHNICAL DETAILS / Dettagli tecnici



Dress 531

High back
Schienale alto



SEAT Sedile	BACK Schienale	FRAME Telaio	OAK Rovere
C Excluding / Escluso C36+C39	C	RS-W-N1- GC-BI	€ 442,00
E	E		€ 611,00
G	G		€ 611,00
H Excluding / Escluso H140+H143	H		€ 459,00
P	P		€ 637,00

For fabrics see page 325
Per i tessuti si veda a p. 325

FINISHES / Finiture



PACKING / Imballo



TECHNICAL DETAILS / Dettagli tecnici

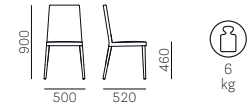

SAFETY, STRENGTH and DURABILITY TESTS
Prove di sicurezza, resistenza e durata
EN 1728:2000

Dress 533

High back
Schienale alto



SEAT Sedile	BACK Schienale	FRAME Telaio	OAK Rovere
C Excluding / Escluso C36+C39	C	RS-W-N1- GC-BI	€ 610,00
E	E		€ 797,00
G	G		€ 797,00
H Excluding / Escluso H140+H143	H		€ 628,00
P	P		€ 900,00

For fabrics see page 325
Per i tessuti si veda a p. 325

FINISHES / Finiture



PACKING / Imballo



TECHNICAL DETAILS / Dettagli tecnici

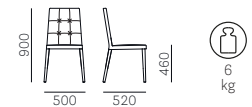

SAFETY, STRENGTH and DURABILITY TESTS
Prove di sicurezza, resistenza e durata
EN 1728:2000

Dress 535



SEAT Sedile	BACK Schienale	FRAME Telaio	OAK Rovere
C Excluding / Escluso C36+C39	C	RS-W-N1- GC-BI	€ 628,00
E	E		€ 771,00
G	G		€ 771,00
H Excluding / Escluso H140+H143	H		€ 647,00
P	P		€ 929,00

For fabrics see page 325
Per i tessuti si veda a p. 325

FINISHES / Finiture



PACKING / Imballo



TECHNICAL DETAILS / Dettagli tecnici

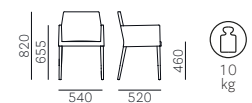

SAFETY, STRENGTH and DURABILITY TESTS
Prove di sicurezza, resistenza e durata
EN 1728:2000

Dress 536



SEAT Sedile	BACK Schienale	FRAME Telaio	OAK Rovere
C Excluding / Escluso C36+C39	C	RS-W-N1- GC-BI	€ 796,00
E	E		€ 986,00
G	G		€ 986,00
H Excluding / Escluso H140+H143	H		€ 819,00
P	P		€ 1.298,00

For fabrics see page 325
Per i tessuti si veda a p. 325

FINISHES / Finiture



PACKING / Imballo



TECHNICAL DETAILS / Dettagli tecnici

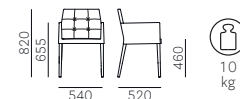

SAFETY, STRENGTH and DURABILITY TESTS
Prove di sicurezza, resistenza e durata
EN 1728:2000

Elinor 3755



SEAT Sedile	BACK Schienale	FRAME Telaio	BLACK POWDER COATED Verniciato nero	POLISHED ALUMINIUM Alluminio lucidato	BRUSHED ALUMINIUM Alluminio satinato
C210+C217	C210+C217	Ø 810	€ 1.303,00	€ 1.433,00	€ 1.823,00
G Excluding / Escluso G07, G180+G185, G230+G239	G		€ 1.443,00	€ 1.573,00	€ 1.963,00
H Excluding / Escluso H40+H53, H140+H143	H		€ 1.323,00	€ 1.453,00	€ 1.843,00
P	P		€ 1.651,00	€ 1.781,00	€ 2.171,00

The armrests in other standard colours are available on request - same price
Disponibile a richiesta i braccioli verniciati in altri colori standard - allo stesso prezzo

For fabrics see page 325
Per i tessuti si veda a p. 325

PACKING / Imballo



TECHNICAL DETAILS / Dettagli tecnici



SAFETY, STRENGTH and DURABILITY TESTS
Prove di sicurezza, resistenza e durata
EN 1728:2012+AC2013
EN 1335-2:2018
ANSI-BIFMA X5.1-2017

Elinor 3756

LOW BACK



SEAT Sedile	BACK Schienale	FRAME Telaio	BLACK POWDER COATED Verniciato nero	POLISHED ALUMINIUM Alluminio lucidato	BRUSHED ALUMINIUM Alluminio satinato
C210+C217	C210+C217	Ø 810	€ 1.251,00	€ 1.381,00	€ 1.771,00
G Excluding / Escluso G07, G180+G185, G230+G239	G		€ 1.391,00	€ 1.521,00	€ 1.911,00
H Excluding / Escluso H40+H53, H140+H143	H		€ 1.271,00	€ 1.401,00	€ 1.791,00
P	P		€ 1.599,00	€ 1.729,00	€ 2.119,00

The armrests in other standard colours are available on request - same price
Disponibile a richiesta i braccioli verniciati in altri colori standard - allo stesso prezzo

For fabrics see page 325
Per i tessuti si veda a p. 325

PACKING / Imballo



TECHNICAL DETAILS / Dettagli tecnici



SAFETY, STRENGTH and DURABILITY TESTS
Prove di sicurezza, resistenza e durata
EN 1728:2012+AC2013
EN 1335-2:2018
ANSI-BIFMA X5.1-2017

Elle 452



SEAT Sedile	BACK Schienale	FRAME Telaio	OAK Rovere
C Excluding / Escluso C36+C39			€ 357,00
E			€ 441,00
G	RS-W-N1- GC-BI	RS-W-N1- GC-BI	€ 441,00
H Excluding / Escluso H140+H143			€ 372,00
P			€ 472,00

For fabrics see page 325
Per i tessuti si veda a p. 325

FINISHES / Finiture



PACKING / Imballo



TECHNICAL DETAILS / Dettagli tecnici

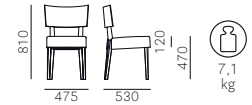

SAFETY, STRENGTH and DURABILITY TESTS
Prove di sicurezza, resistenza e durata
EN 1728:2000

Enjoy 460



SEAT Sedile	BACK Schienale	FRAME Telaio	POLYPROPYLENE Polipropilene
PPL	PPL	PPL	€ 128,00

PPL FINISHES / Finiture PPL



PACKING / Imballo



TECHNICAL DETAILS / Dettagli tecnici

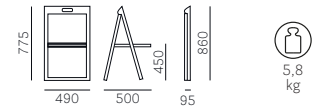

SAFETY, STRENGTH and DURABILITY TESTS
Prove di sicurezza, resistenza e durata
EN 1728:2000
ANSI BIFMA X5.4-2012

Ester 691



SEAT Sedile	BACK Schienale	BRUSHED NICKEL Nichel satinato	BRUSHED BRONZE Bronzo satinato	ANTIQUE BRASS Ottone anticato	TITANIUM Titanio
G Excluding / Escluso G100+G102, G130+G133, G200+G206	G	€ 1.027,00	€ 1.027,00	€ 1.027,00	€ 1.027,00
H Excluding / Escluso H120+H127, H140+H143	H	€ 938,00	€ 938,00	€ 938,00	€ 938,00
P	P	€ 1.154,00	€ 1.154,00	€ 1.154,00	€ 1.154,00

Upcharge for double-colour upholstery € 43,00
Supplemento tappezzeria bicolore € 43,00

For fabrics see page 325
Per i tessuti si veda a p. 325

PACKING / Imballo



TECHNICAL DETAILS / Dettagli tecnici



SAFETY, STRENGTH and DURABILITY TESTS
Prove di sicurezza, resistenza e durata
EN 1728:2012+AC2013
EN 16139:2013 level 2

Ester 690



SEAT Sedile	BACK Schienale	BRUSHED NICKEL Nichel satinato	BRUSHED BRONZE Bronzo satinato	ANTIQUE BRASS Ottone anticato	TITANIUM Titanio
G Excluding / Escluso G100+G102, G130+G133, G200+G206	G	€ 1.234,00	€ 1.234,00	€ 1.234,00	€ 1.234,00
H Excluding / Escluso H120+H127, H140+H143	H	€ 1.102,00	€ 1.102,00	€ 1.102,00	€ 1.102,00
P	P	€ 1.350,00	€ 1.350,00	€ 1.350,00	€ 1.350,00

Upcharge for double-colour upholstery € 43,00
Supplemento tappezzeria bicolore € 43,00

For fabrics see page 325
Per i tessuti si veda a p. 325

PACKING / Imballo



TECHNICAL DETAILS / Dettagli tecnici

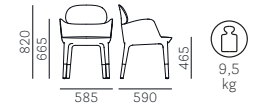

SAFETY, STRENGTH and DURABILITY TESTS
Prove di sicurezza, resistenza e durata
EN 1728:2012+AC2013
EN 16139:2013 level 2

Ester 695



SEAT Sedile	BACK Schienale	BLACK POWDER COATED Verniciato nero	POLISHED ALUMINIUM Alluminio lucidato
G Excluding / Escluso G100+G102, G130+G133, G200+G206	G	€ 1.196,00	€ 1.196,00
H Excluding / Escluso H120+H127, H140+H143	H	€ 1.095,00	€ 1.095,00
P	P	€ 1.347,00	€ 1.347,00

Chromed inner column
Colonna interna cromata

Upcharge for double-colour upholstery € 43,00
Supplemento tappezzeria bicolore € 43,00

For fabrics see page 325
Per i tessuti si veda a p. 325

PACKING / Imballo



TECHNICAL DETAILS / Dettagli tecnici



Ester 695F



SEAT Sedile	BACK Schienale	BLACK POWDER COATED Verniciato nero	POLISHED ALUMINIUM Alluminio lucidato
G Excluding / Escluso G100+G102, G130+G133, G200+G206	G	€ 1.225,00	€ 1.225,00
H Excluding / Escluso H120+H127, H140+H143	H	€ 1.124,00	€ 1.124,00
P	P	€ 1.376,00	€ 1.376,00

Chromed inner column
Colonna interna cromata

Upcharge for double-colour upholstery € 43,00
Supplemento tappezzeria bicolore € 43,00

For fabrics see page 325
Per i tessuti si veda a p. 325

PACKING / Imballo



TECHNICAL DETAILS / Dettagli tecnici



Ester 696

High back
Schienale alto



SEAT Sedile	BACK Schienale	BLACK POWDER COATED Verniciato nero	POLISHED ALUMINIUM Alluminio lucidato
G Excluding / Escluso G100+G102, G130+G133, G200+G206	G	€ 1.316,00	€ 1.316,00
H Excluding / Escluso H120+H127, H140+H143	H	€ 1.204,00	€ 1.204,00
P	P	€ 1.481,00	€ 1.481,00
		Chromed inner column Colonna interna cromata	
Upcharge for double-colour upholstery € 43,00 Supplemento tappezzeria bicolore € 43,00			
For fabrics see page 325 Per i tessuti si veda a p. 325			
		PACKING / Imballo	TECHNICAL DETAILS / Dettagli tecnici



Ester 696F

High back
Schienale alto



SEAT Sedile	BACK Schienale	BLACK POWDER COATED Verniciato nero	POLISHED ALUMINIUM Alluminio lucidato
G Excluding / Escluso G100+G102, G130+G133, G200+G206	G	€ 1.345,00	€ 1.345,00
H Excluding / Escluso H120+H127, H140+H143	H	€ 1.233,00	€ 1.233,00
P	P	€ 1.510,00	€ 1.510,00
		Chromed inner column Colonna interna cromata	
Upcharge for double-colour upholstery € 43,00 Supplemento tappezzeria bicolore € 43,00			
For fabrics see page 325 Per i tessuti si veda a p. 325			
		PACKING / Imballo	TECHNICAL DETAILS / Dettagli tecnici



Ester 693

POUF



SEAT Sedile	BRUSHED NICKEL Nichel satinato	BRUSHED BRONZE Bronzo satinato	ANTIQUÉ BRASS Ottone anticato	TITANIUM Titanio
G Excluding / Escluso G100+G102, G130+G133, G200+G206	€ 783,00	€ 783,00	€ 783,00	€ 783,00
H Excluding / Escluso H120+H127, H140+H143	€ 718,00	€ 718,00	€ 718,00	€ 718,00
P	€ 927,00	€ 927,00	€ 927,00	€ 927,00
For fabrics see page 325 Per i tessuti si veda a p. 325				
		PACKING / Imballo	TECHNICAL DETAILS / Dettagli tecnici	



Ester 698_H650



SEAT Sedile	BACK Schienale	FRAME Telaio	BRUSHED NICKEL Nichel satinato	BRUSHED BRONZE Bronzo satinato	ANTIQUÉ BRASS Ottone anticato	TITANIUM Titanio
G Excluding / Escluso G100+G102, G130+G133, G200+G206	G	H650	€ 1.264,00	€ 1.264,00	€ 1.264,00	€ 1.264,00
H Excluding / Escluso H120+H127, H140+H143	H		€ 1.164,00	€ 1.164,00	€ 1.164,00	€ 1.164,00
P	P		€ 1.469,00	€ 1.469,00	€ 1.469,00	€ 1.469,00

Upcharge for double-colour upholstery € 43,00
Supplemento tappezzeria bicolore € 43,00

For fabrics see page 325
Per i tessuti si veda a p. 325

PACKING / Imballo



TECHNICAL DETAILS / Dettagli tecnici

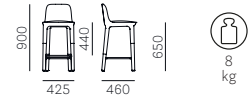

Ester 698



SEAT Sedile	BACK Schienale	FRAME Telaio	BRUSHED NICKEL Nichel satinato	BRUSHED BRONZE Bronzo satinato	ANTIQUÉ BRASS Ottone anticato	TITANIUM Titanio
G Excluding / Escluso G100+G102, G130+G133, G200+G206	G	H750	€ 1.235,00	€ 1.235,00	€ 1.235,00	€ 1.235,00
H Excluding / Escluso H120+H127, H140+H143	H		€ 1.135,00	€ 1.135,00	€ 1.135,00	€ 1.135,00
P	P		€ 1.441,00	€ 1.441,00	€ 1.441,00	€ 1.441,00

Upcharge for double-colour upholstery € 43,00
Supplemento tappezzeria bicolore € 43,00

For fabrics see page 325
Per i tessuti si veda a p. 325

PACKING / Imballo



TECHNICAL DETAILS / Dettagli tecnici

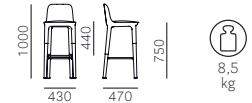

Folk 2930



SEAT Sedile	BACK Schienale	FRAME Telaio	ASH Frassino	
			POWDER COATED Verniciato	POLISHED ALUMINIUM Alluminio lucidato
FR-N1-GC-BI-AN	FR-N1-GC-BI-AN	FR-N1-GC-BI-AN	€ 366,00	€ 396,00

FINISHES / Finiture

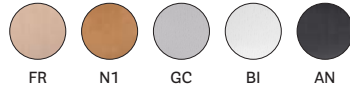

PACKING / Imballo



TECHNICAL DETAILS / Dettagli tecnici

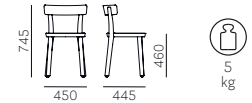

SAFETY, STRENGTH and DURABILITY TESTS
 Prove di sicurezza, resistenza e durata
 EN 1728:2012+AC2013
 EN 16139:2013 level 2



Folk 2920



SEAT Sedile	BACK Schienale	FRAME Telaio	ASH Frassino	
			POWDER COATED Verniciato	POLISHED ALUMINIUM Alluminio lucidato
Cane / Canna	FR-N1-GC-BI-AN	FR-N1-GC-BI-AN	€ 433,00	€ 463,00

FINISHES / Finiture

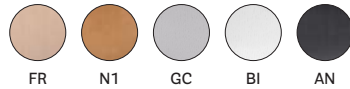

PACKING / Imballo



TECHNICAL DETAILS / Dettagli tecnici

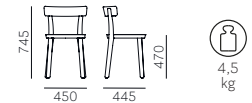

SAFETY, STRENGTH and DURABILITY TESTS
 Prove di sicurezza, resistenza e durata
 EN 1728:2012+AC2013
 EN 16139:2013 level 2



Folk 2940



SEAT Sedile	BACK Schienale	FRAME Telaio	ASH Frassino	
			POWDER COATED Verniciato	POLISHED ALUMINIUM Alluminio lucidato
C Excluding / Escluso C36+C39 D40+D44			€ 376,00	€ 406,00
			€ 389,00	€ 419,00
E	FR-N1-GC-BI-AN	FR-N1-GC-BI-AN	€ 409,00	€ 439,00
G			€ 409,00	€ 439,00
H Excluding / Escluso H140+H143			€ 380,00	€ 410,00
P			€ 484,00	€ 514,00

FINISHES / Finiture



PACKING / Imballo



TECHNICAL DETAILS / Dettagli tecnici



SAFETY, STRENGTH and DURABILITY TESTS
 Prove di sicurezza, resistenza e durata
 EN 1728:2012+AC2013
 EN 16139:2013 level 2

For fabrics see page 325
 Per i tessuti si veda a p. 325

For colours and finishes see at page 320
 Per colori e finiture vedere da pagina 320



Folk 2936



SEAT Sedile	BACK Schienale	FRAME Telaio	ASH Frassino	
			POWDER COATED Verniciato	POLISHED ALUMINIUM Alluminio lucidato
FR-N1-GC-BI-AN	FR-N1-GC-BI-AN	H650	€ 498,00	€ 546,00

FINISHES / Finiture

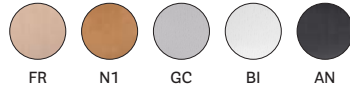

PACKING / Imballo



TECHNICAL DETAILS / Dettagli tecnici



SAFETY, STRENGTH and DURABILITY TESTS
 Prove di sicurezza, resistenza e durata
 EN 1728:2012+AC2013
 EN 16139:2013 level 2



Folk 2926



SEAT Sedile	BACK Schienale	FRAME Telaio	ASH Frassino	
			POWDER COATED Verniciato	POLISHED ALUMINIUM Alluminio lucidato
Cane / Canna	FR-N1-GC-BI-AN	H650	€ 566,00	€ 613,00

FINISHES / Finiture

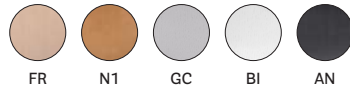

PACKING / Imballo



TECHNICAL DETAILS / Dettagli tecnici



SAFETY, STRENGTH and DURABILITY TESTS
 Prove di sicurezza, resistenza e durata
 EN 1728:2012+AC2013
 EN 16139:2013 level 2



Folk 2946



SEAT Sedile	BACK Schienale	FRAME Telaio	ASH Frassino	
			POWDER COATED Verniciato	POLISHED ALUMINIUM Alluminio lucidato
C Excluding / Escluso C36+C39	FR-N1-GC-BI-AN	H690	€ 509,00	€ 556,00
D40÷D44			€ 522,00	€ 569,00
E			€ 541,00	€ 589,00
G			€ 541,00	€ 589,00
H Excluding / Escluso H140+H143			€ 513,00	€ 561,00
P	€ 618,00	€ 665,00		

FINISHES / Finiture



PACKING / Imballo



TECHNICAL DETAILS / Dettagli tecnici



SAFETY, STRENGTH and DURABILITY TESTS
 Prove di sicurezza, resistenza e durata
 EN 1728:2012+AC2013
 EN 16139:2013 level 2

For fabrics see page 325
 Per i tessuti si veda a p. 325

For colours and finishes see at page 320
 Per colori e finiture vedere da pagina 320



Folk 2937



SEAT Sedile	BACK Schienale	FRAME Telaio	ASH Frassino	
			POWDER COATED Verniciato	POLISHED ALUMINIUM Alluminio lucidato
FR-N1-GC-BI-AN	FR-N1-GC-BI-AN	H750	€ 505,00	€ 552,00

FINISHES / Finiture



PACKING / Imballo



TECHNICAL DETAILS / Dettagli tecnici



SAFETY, STRENGTH and DURABILITY TESTS
 Prove di sicurezza, resistenza e durata
 EN 1728:2012+AC2013
 EN 16139:2013 level 2



Folk 2927



SEAT Sedile	BACK Schienale	FRAME Telaio	ASH Frassino	
			POWDER COATED Verniciato	POLISHED ALUMINIUM Alluminio lucidato
Cane / Canna	FR-N1-GC-BI-AN	H750	€ 571,00	€ 619,00

FINISHES / Finiture



PACKING / Imballo



TECHNICAL DETAILS / Dettagli tecnici



SAFETY, STRENGTH and DURABILITY TESTS
 Prove di sicurezza, resistenza e durata
 EN 1728:2012+AC2013
 EN 16139:2013 level 2



Folk 2947



SEAT Sedile	BACK Schienale	FRAME Telaio	ASH Frassino	
			POWDER COATED Verniciato	POLISHED ALUMINIUM Alluminio lucidato
C Excluding / Escluso C36+C39	FR-N1-GC-BI-AN	H790	€ 514,00	€ 562,00
D40+D44			€ 527,00	€ 575,00
E			€ 548,00	€ 595,00
G			€ 548,00	€ 595,00
H Excluding / Escluso H140+H143			€ 519,00	€ 566,00
P			€ 623,00	€ 670,00

FINISHES / Finiture



PACKING / Imballo



TECHNICAL DETAILS / Dettagli tecnici



SAFETY, STRENGTH and DURABILITY TESTS
 Prove di sicurezza, resistenza e durata
 EN 1728:2012+AC2013
 EN 16139:2013 level 2

For fabrics see page 325
 Per i tessuti si veda a p. 325

For colours and finishes see at page 320
 Per colori e finiture vedere da pagina 320



Fox 3725



SEAT Sedile	BACK Schienale	FRAME Telaio	BLEACHED ASH Frassino sbiancato	BLACK LACQUERED ASH Frassino laccato nero
PPL	PPL + FR	FR	€ 301,00 (BI, SA, BL)	€ 301,00 (BL, ML, NE)
PPL	PPL + AN	AN		

PPL FINISHES / Finiture PPL

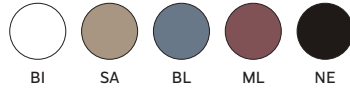

WOODEN FINISHES / Finiture legno



PACKING / Imballo



TECHNICAL DETAILS / Dettagli tecnici



SAFETY, STRENGTH and DURABILITY TESTS
Prove di sicurezza, resistenza e durata
EN 1728:2012+AC2013
EN 16139:2013 level 2



Fox 3727



SEAT Sedile	BACK Schienale	FRAME Telaio	BLEACHED ASH Frassino sbiancato	BLACK LACQUERED ASH Frassino laccato nero
F04	F04 + FR	FR	€ 658,00	€ 658,00
F04+F05	F04+F05 + AN	AN		

GENUINE LEATHER FINISHES / Finiture cuoio naturale



WOODEN FINISHES / Finiture legno



PACKING / Imballo



TECHNICAL DETAILS / Dettagli tecnici



SAFETY, STRENGTH and DURABILITY TESTS
Prove di sicurezza, resistenza e durata
EN 1728:2012+AC2013
EN 16139:2013 level 2



Fox 3723



SEAT Sedile	BACK Schienale	FRAME Telaio	ASH Frassino
C83+C89; C100+C101 C110+C122 C210+C217	C83+C89; C100+C101 C110+C122 C210+C217	FR-AN	€ 673,00
E G21+G24 G100+G102 G110+G116 G140+G146 G150+G156 G180+G185 G230+G239	E G21+G24 G100+G102 G110+G116 G140+G146 G150+G156 G180+G185 G230+G239		€ 782,00
H40+H53 H120+H127	H40+H53 H120+H127		€ 782,00
			€ 687,00

WOODEN FINISHES / Finiture legno



PACKING / Imballo



TECHNICAL DETAILS / Dettagli tecnici



SAFETY, STRENGTH and DURABILITY TESTS
Prove di sicurezza, resistenza e durata
EN 1728:2012+AC2013
EN 16139:2013 level 2

For fabrics see page 325
Per i tessuti si veda a p. 325



Fox 3726



SEAT Sedile	BACK Schienale	FRAME Telaio	BEIGE POWDER COATED Verniciato beige	SAND POWDER COATED Verniciato sabbia	BLACK POWDER COATED Verniciato nero
PPL	PPL + FR	Ø 14	€ 223,00 (BI)	€ 223,00 (SA, BL)	€ 223,00 (BI, ML, NE)
PPL	PPL + AN				

SAFETY, STRENGTH and DURABILITY TESTS
 Prove di sicurezza, resistenza e durata
 EN 1728:2012+AC2013
 EN 16139:2013 level 2

PPL FINISHES / Finiture PPL



**WOODEN FINISHES
Finiture legno**



**POWDER COATED FINISHES
Finiture verniciato**



PACKING / Imballo



TECHNICAL DETAILS / Dettagli tecnici



Fox 3728



SEAT Sedile	BACK Schienale	FRAME Telaio	BLACK POWDER COATED Verniciato nero
F04	F04 + FR	Ø 14	€ 580,00
F04+F05	F04+F05 + AN		

SAFETY, STRENGTH and DURABILITY TESTS
 Prove di sicurezza, resistenza e durata
 EN 1728:2012+AC2013
 EN 16139:2013 level 2

GENUINE LEATHER FINISHES / Finiture cuoio naturale



**WOODEN FINISHES
Finiture legno**



**POWDER COATED FINISH
Finitura verniciato**



PACKING / Imballo



TECHNICAL DETAILS / Dettagli tecnici



Fox 3724



SEAT Sedile	BACK Schienale	FRAME Telaio	BLACK POWDER COATED Verniciato nero
C83+C89; C100+C101 C110+C122 C210+C217	C83+C89; C100+C101 C110+C122 C210+C217	Ø 14	€ 595,00
E	E		€ 704,00
G21+G24 G100+G102 G110+G116 G140+G146 G150+G156 G180+G185 G230+G239	G21+G24 G100+G102 G110+G116 G140+G146 G150+G156 G180+G185 G230+G239		€ 704,00
H40+H53 H120+H127	H40+H53 H120+H127		€ 609,00

SAFETY, STRENGTH and DURABILITY TESTS
 Prove di sicurezza, resistenza e durata
 EN 1728:2012+AC2013
 EN 16139:2013 level 2

WOODEN FINISHES / Finiture legno



For fabrics see page 325
 Per i tessuti si veda a p. 325

PACKING / Imballo



TECHNICAL DETAILS / Dettagli tecnici

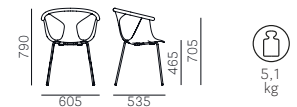

Frida 752



SEAT Sedile	BACK Schienale	FRAME Telaio	OAK Rovere
RS-W-N1- GC-BI	RS-W-N1- GC-BI	RS-W-N1- GC-BI	€ 623,00

FINISHES / Finiture



PACKING / Imballo



TECHNICAL DETAILS / Dettagli tecnici

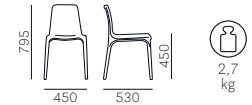

SAFETY, STRENGTH and DURABILITY TESTS
Prove di sicurezza, resistenza e durata
EN 1728:2000



Frida 752



SEAT Sedile	BACK Schienale	FRAME Telaio	OAK Rovere
BL2 AZ1 VE2 VE1 RB RA MO MC	BL2 AZ1 VE2 VE1 RB RA MO MC	BL2 AZ1 VE2 VE1 RB RA MO MC	€ 637,00 Lacquered with visible grains Laccato a poro aperto

FINISHES / Finiture



PACKING / Imballo



TECHNICAL DETAILS / Dettagli tecnici



SAFETY, STRENGTH and DURABILITY TESTS
Prove di sicurezza, resistenza e durata
EN 1728:2000



Glam 430



SEAT Sedile	BACK Schienale	FRAME Telaio	OAK Rovere
C Excluding / Escluso C36+C39			€ 342,00
G	RS-W-N1- GC-BI	RS-W-N1- GC-BI	€ 400,00
H Excluding / Escluso H140+H143			€ 348,00
P			€ 410,00

For fabrics see page 325
Per i tessuti si veda a p. 325

FINISHES / Finiture



PACKING / Imballo



TECHNICAL DETAILS / Dettagli tecnici

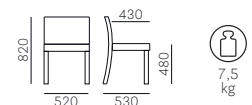

Glam 431



SEAT Sedile	BACK Schienale	FRAME Telaio	OAK Rovere
C Excluding / Escluso C36+C39			€ 342,00
G	RS-W-N1- GC-BI	RS-W-N1- GC-BI	€ 400,00
H Excluding / Escluso H140+H143			€ 348,00
P			€ 410,00

For fabrics see page 325
Per i tessuti si veda a p. 325

FINISHES / Finiture



SAFETY, STRENGTH and DURABILITY TESTS
Prove di sicurezza, resistenza e durata
EN 1728:2000

PACKING / Imballo



TECHNICAL DETAILS / Dettagli tecnici

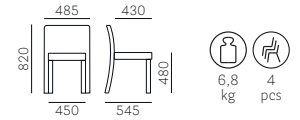

Glam 432



SEAT Sedile	BACK Schienale	FRAME Telaio	OAK Rovere
C Excluding / Escluso C36+C39			€ 368,00
G	Cane / Canna	RS-W	€ 424,00
H Excluding / Escluso H140+H143			€ 379,00
P			€ 450,00

For fabrics see page 325
Per i tessuti si veda a p. 325

WOODEN FINISHES / Finiture legno



CANE FINISHES / Finiture canna



PACKING / Imballo



TECHNICAL DETAILS / Dettagli tecnici

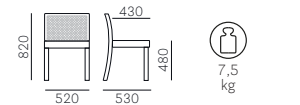

Glam 433



SEAT Sedile	BACK Schienale	FRAME Telaio	OAK Rovere
C Excluding / Escluso C36+C39			€ 368,00
G	Cane / Canna	RS-W	€ 424,00
H Excluding / Escluso H140+H143			€ 379,00
P			€ 450,00

For fabrics see page 325
Per i tessuti si veda a p. 325

WOODEN FINISHES / Finiture legno



CANE FINISHES / Finiture canna

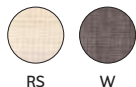

PACKING / Imballo



TECHNICAL DETAILS / Dettagli tecnici

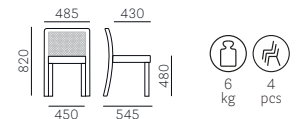

Glam 435

VAT NOT INCLUDED / Iva esclusa

Seating / Sedute



SEAT Sedile	BACK Schienale	FRAME Telaio	OAK Rovere
C Excluding / Escluso C36+C39	C	RS-W-N1- GC-BI	€ 396,00
G	G		€ 472,00
H Excluding / Escluso H140+H143	H		€ 389,00
P	P		€ 519,00

For fabrics see page 325
Per i tessuti si veda a p. 325

FINISHES / Finiture



PACKING / Imballo



TECHNICAL DETAILS / Dettagli tecnici

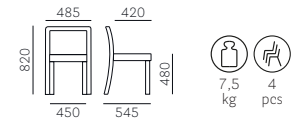

Gliss 900.3



SEAT Sedile	FABRIC Tessuto
C	€ 98,00
E	€ 156,00
G	€ 156,00
H	€ 104,00

Excluding / Escluso H140+H143
For fabrics see page 325
Per i tessuti si veda a p. 325

PACKING / Imballo



TECHNICAL DETAILS / Dettagli tecnici

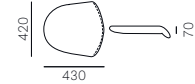

Gliss 900.8

Fabric covering only
Solo vestina



SEAT Sedile	BACK Schienale	FABRIC Tessuto
C Excluding / Escluso C36+C39	C	€ 345,00
E	E	€ 517,00
G	G	€ 517,00
H	H	€ 359,00

Excluding / Escluso H140+H143
For technopolymer shell only
Solo per scocca tecnopolimero
For fabrics see page 325
Per i tessuti si veda a p. 325

PACKING / Imballo



TECHNICAL DETAILS / Dettagli tecnici



Gliss 904

WOOD



SEAT Sedile	BACK Schienale	FRAME Telaio	ASH Frassino
TP	TP	FR-AN-N1	€ 225,00

White powder-coated steel rod frame, for BI shell with FR frame. Black powder-coated steel rod frame for other versions
Telaio in tondino verniciato bianco, per scocca BI con telaio FR. Telaio in tondino verniciato nero per le altre versioni

TP FINISHES / Finiture TP



WOODEN FINISHES / Finiture legno



PACKING / Imballo



TECHNICAL DETAILS / Dettagli tecnici



SAFETY, STRENGTH and DURABILITY TESTS
Prove di sicurezza, resistenza e durata
EN 1728:2000



Gliss 905

WOOD



SEAT Sedile	BACK Schienale	FRAME Telaio	ASH Frassino
PC	PC	FR-AN-N1	€ 247,00

SAFETY, STRENGTH and DURABILITY TESTS
 Prove di sicurezza, resistenza e durata
 EN 1728:2000

PC FINISHES / Finiture PC



WOODEN FINISHES / Finiture legno



PACKING / Imballo



TECHNICAL DETAILS / Dettagli tecnici

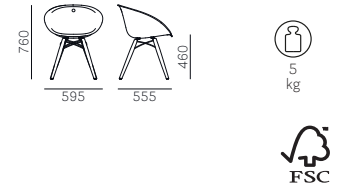

Gliss 920



SEAT Sedile	BACK Schienale	FRAME Telaio	POWDER COATED Verniciato	CHROMED Cromato
TP	TP	Ø 10	€ 125,00	€ 125,00

SAFETY, STRENGTH and DURABILITY TESTS
 Prove di sicurezza, resistenza e durata
 EN 1022:1998

TP FINISHES / Finiture TP



PACKING / Imballo



TECHNICAL DETAILS / Dettagli tecnici



Gliss 921



SEAT Sedile	BACK Schienale	FRAME Telaio	POWDER COATED Verniciato	CHROMED Cromato
PC	PC	Ø 10	€ 150,00	€ 150,00

SAFETY, STRENGTH and DURABILITY TESTS
 Prove di sicurezza, resistenza e durata
 EN 1022:1998
 EN 1728:2000

PC FINISHES / Finiture PC



PACKING / Imballo



TECHNICAL DETAILS / Dettagli tecnici



For colours and finishes see at page 320
 Per colori e finiture vedere da pagina 320

Gliss 921/CL1

Fire retardant version
Versione ignifuga



SEAT Sedile	BACK Schienale	FRAME Telaio	POWDER COATED Verniciato	CHROMED Cromato
PC	PC	Ø 10	€ 173,00	€ 173,00

Minimum order 300 pcs
Ordine minimo 300 pz

PC FINISHES / Finiture PC



SAFETY, STRENGTH and DURABILITY TESTS
Prove di sicurezza, resistenza e durata
EN 1022:1998
EN 1728:2000

PACKING / Imballo



TECHNICAL DETAILS / Dettagli tecnici



Gliss 960/2

Gas lift device
Alzata a gas



SEAT Sedile	BACK Schienale	FRAME Telaio	WHITE/BLACK POWDER COATED Verniciato bianco/nero	POLISHED ALUMINIUM Alluminio lucidato
TP	TP	Ø 750	€ 233,00	€ 311,00

TP FINISHES / Finiture TP



PACKING / Imballo



TECHNICAL DETAILS / Dettagli tecnici

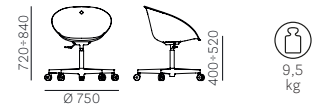

Gliss 961/2

Gas lift device
Alzata a gas



SEAT Sedile	BACK Schienale	FRAME Telaio	BLACK POWDER COATED Verniciato nero	POLISHED ALUMINIUM Alluminio lucidato
PC	PC	Ø 750	€ 255,00	€ 333,00

PC FINISHES / Finiture PC



PACKING / Imballo



TECHNICAL DETAILS / Dettagli tecnici

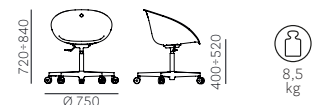

For colours and finishes see at page 320
Per colori e finiture vedere da pagina 320

Gliss 968



SEAT Sedile	BACK Schienale	FRAME Telaio	CHROMED Cromato
PC	PC	Ø 16	€ 242,00

PC FINISHES / Finiture PC

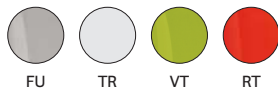

PACKING / Imballo



TECHNICAL DETAILS / Dettagli tecnici



Gliss 904/F

WOOD



SEAT Sedile	BACK Schienale	FRAME Telaio	ASH Frassino
F01; F04+F09	F01; F04+F09	FR-AN-N1	€ 992,00

For fabrics see page 325
Per i tessuti si veda a p. 325

WOODEN FINISHES / Finiture legno



PACKING / Imballo



TECHNICAL DETAILS / Dettagli tecnici

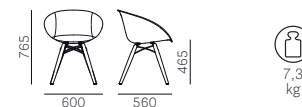

SAFETY, STRENGTH and DURABILITY TESTS
Prove di sicurezza, resistenza e durata
EN 1728:2000



Gliss 930



SEAT Sedile	BACK Schienale	FRAME Telaio	CHROMED Cromato
F01; F04+F09	F01; F04+F09	Ø 10	€ 882,00

For fabrics see page 325
Per i tessuti si veda a p. 325

PACKING / Imballo



TECHNICAL DETAILS / Dettagli tecnici



Gliss 966/2F

Gas lift device
Alzata a gas



SEAT Sedile	BACK Schienale	FRAME Telaio	WHITE/BLACK POWDER COATED Verniciato bianco/nero	POLISHED ALUMINIUM Alluminio lucidato
F01; F04+F09	F01; F04+F09	Ø 750	€ 1.001,00	€ 1.083,00

For fabrics see page 325
Per i tessuti si veda a p. 325

PACKING / Imballo



TECHNICAL DETAILS / Dettagli tecnici



Gliss 900/A



SEAT Sedile	BACK Schienale	FRAME Telaio	BLACK POWDER COATED Verniciato nero	CHROMED Cromato
C Excluding / Escluso C36+C39	C	Ø 16	€ 569,00	€ 569,00
E	E		€ 764,00	€ 764,00
G	G		€ 764,00	€ 764,00
H Excluding / Escluso H140+H143	H		€ 579,00	€ 579,00

For fabrics see page 325
Per i tessuti si veda a p. 325

PACKING / Imballo



TECHNICAL DETAILS / Dettagli tecnici



Gliss 904/A

WOOD



SEAT Sedile	BACK Schienale	FRAME Telaio	ASH Frassino
C Excluding / Escluso C36+C39	C	FR-AN-N1	€ 680,00
E	E		€ 874,00
G	G		€ 874,00
H Excluding / Escluso H140+H143	H		€ 691,00

For fabrics see page 325
Per i tessuti si veda a p. 325

WOODEN FINISHES / Finiture legno



PACKING / Imballo



TECHNICAL DETAILS / Dettagli tecnici



SAFETY, STRENGTH and DURABILITY TESTS
Prove di sicurezza, resistenza e durata
EN 1728:2000



Gliss 920+900.8



SEAT Sedile	BACK Schienale	FRAME Telaio	POWDER COATED Verniciato	CHROMED Cromato
C Excluding / Escluso C36+C39	C	Ø 10	€ 470,00	€ 470,00
E	E		€ 641,00	€ 641,00
G	G		€ 641,00	€ 641,00
H Excluding / Escluso H140+H143	H		€ 483,00	€ 483,00

For fabrics see page 325
Per i tessuti si veda a p. 325

TP FINISHES / Finiture TP



SAFETY, STRENGTH and DURABILITY TESTS
Prove di sicurezza, resistenza e durata
EN 1022:1998

PACKING / Imballo



TECHNICAL DETAILS / Dettagli tecnici



Gliss 1020



SEAT Sedile	BACK Schienale	FRAME Telaio	CHROMED Cromato
C Excluding / Escluso C36+C39	C	Ø 10	€ 569,00
E	E		€ 764,00
G	G		€ 764,00
H Excluding / Escluso H140+H143	H		€ 579,00

For fabrics see page 325
Per i tessuti si veda a p. 325

PACKING / Imballo



TECHNICAL DETAILS / Dettagli tecnici



SAFETY, STRENGTH and DURABILITY TESTS
Prove di sicurezza, resistenza e durata
EN 1728:2000

Gliss 902



SEAT Sedile	BACK Schienale	FRAME Telaio	WHITE/BLACK POWDER COATED Verniciato bianco/nero	CHROMED Cromato
PC	PC	Ø 11 H650	€ 162,00 Powder coated in the same colour of the shell Verniciato in tinta con la scocca	€ 162,00

PC FINISHES / Finiture PC



SAFETY, STRENGTH and DURABILITY TESTS
Prove di sicurezza, resistenza e durata
EN 1728:2000

PACKING / Imballo



TECHNICAL DETAILS / Dettagli tecnici

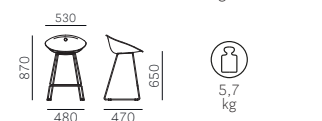

For colours and finishes see at page 320
Per colori e finiture vedere da pagina 320

Gliss 906



SEAT Sedile	BACK Schienale	FRAME Telaio	WHITE/BLACK POWDER COATED Verniciato bianco/nero	CHROMED Cromato
PC	PC	Ø 11 H750	<p>€ 177,00</p> <p>Powder coated in the same colour of the shell Verniciato in tinta con la scocca</p>	<p>€ 177,00</p>

PC FINISHES / Finiture PC

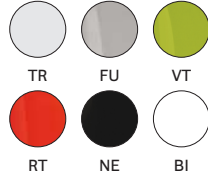

PACKING / Imballo



TECHNICAL DETAILS / Dettagli tecnici

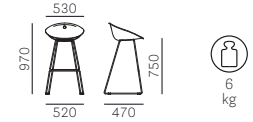

SAFETY, STRENGTH and DURABILITY TESTS
Prove di sicurezza, resistenza e durata
EN 1728:2000

Gliss 970

Gas lift device
Alzata a gas



SEAT Sedile	BACK Schienale	FRAME Telaio	CHROMED Cromato
PC	PC	Ø 400 H555+815	<p>€ 394,00</p>

PC FINISHES / Finiture PC

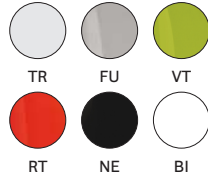

PACKING / Imballo



TECHNICAL DETAILS / Dettagli tecnici

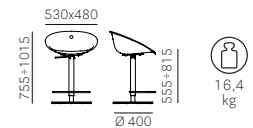

SAFETY, STRENGTH and DURABILITY TESTS
Prove di sicurezza, resistenza e durata
EN 1728:2000

Gliss 932



SEAT Sedile	BACK Schienale	FRAME Telaio	WHITE/BLACK POWDER COATED Verniciato bianco/nero	CHROMED Cromato
F01; F04+F09	F01; F04+F09	Ø 11 H660	<p>€ 756,00</p>	<p>€ 756,00</p>

GENUINE LEATHER FINISHES / Finiture cuoio naturale



PACKING / Imballo



TECHNICAL DETAILS / Dettagli tecnici

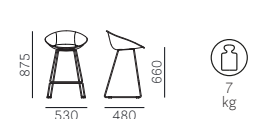

Gliss 936



SEAT Sedile	BACK Schienale	FRAME Telaio	WHITE/BLACK POWDER COATED Verniciato bianco/nero	CHROMED Cromato
F01; F04+F09	F01; F04+F09	Ø 11 H760	€ 771,00	€ 771,00

GENUINE LEATHER FINISHES / Finiture cuoio naturale



PACKING / Imballo

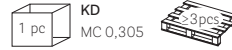

TECHNICAL DETAILS / Dettagli tecnici

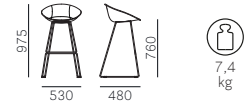

Gliss 990

Gas lift device
Alzata a gas



SEAT Sedile	BACK Schienale	FRAME Telaio	CHROMED Cromato
F01; F04+F09	F01; F04+F09	Ø 400 H565+825	€ 1.016,00

GENUINE LEATHER FINISHES / Finiture cuoio naturale



PACKING / Imballo



TECHNICAL DETAILS / Dettagli tecnici

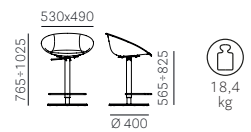

SAFETY, STRENGTH and DURABILITY TESTS
Prove di sicurezza, resistenza e durata
EN 1728:2000

Gliss 912



SEAT Sedile	BACK Schienale	FRAME Telaio	WHITE/BLACK POWDER COATED Verniciato bianco/nero	CHROMED Cromato
C Excluding / Escluso C36+C39	C	Ø 11 H670	€ 492,00	€ 492,00
E	E		€ 686,00	€ 686,00
G	G		€ 686,00	€ 686,00
H Excluding / Escluso H140+H143	H		€ 504,00	€ 504,00

For fabrics see page 325
Per i tessuti si veda a p. 325

PACKING / Imballo



TECHNICAL DETAILS / Dettagli tecnici

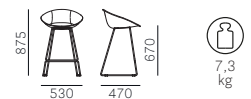

Gliss 916



SEAT Sedile	BACK Schienale	FRAME Telaio	WHITE/BLACK POWDER COATED Verniciato bianco/nero	CHROMED Cromato
C Excluding / Escluso C36+C39	C	Ø 11 H770	€ 509,00	€ 509,00
E	E		€ 702,00	€ 702,00
G	G		€ 702,00	€ 702,00
H Excluding / Escluso H140+H143	H		€ 520,00	€ 520,00

For fabrics see page 325
Per i tessuti si veda a p. 325

PACKING / Imballo

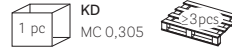

TECHNICAL DETAILS / Dettagli tecnici

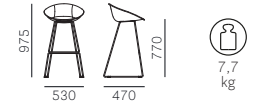

Gliss 980

Gas lift device
Alzata a gas



SEAT Sedile	BACK Schienale	FRAME Telaio	CHROMED Cromato
C Excluding / Escluso C36+C39	C	Ø 400 H565*825	€ 718,00
E	E		€ 897,00
G	G		€ 897,00
H Excluding / Escluso H140+H143	H		€ 714,00

For fabrics see page 325
Per i tessuti si veda a p. 325

PACKING / Imballo



TECHNICAL DETAILS / Dettagli tecnici

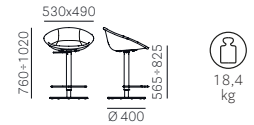

SAFETY, STRENGTH and DURABILITY TESTS
Prove di sicurezza, resistenza e durata
EN 1728:2000

Gliss 340

LOUNGE



SEAT Sedile	BACK Schienale	FRAME Telaio	POWDER COATED Verniciato	CHROMED Cromato
TP	TP	Ø 12	€ 205,00	€ 205,00

TP FINISHES / Finiture TP



SAFETY, STRENGTH and DURABILITY TESTS
Prove di sicurezza, resistenza e durata
EN 1728:2000

PACKING / Imballo



TECHNICAL DETAILS / Dettagli tecnici

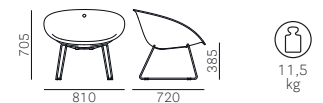

For colours and finishes see at page 320
Per colori e finiture vedere da pagina 320

Gliss 350

SWING



SEAT Sedile	BACK Schienale	FRAME Telaio	CHROMED Cromato
TP	TP	Ø 12	€ 335,00

TP FINISHES / Finiture TP



WOODEN FINISHES / Finiture legno



PACKING / Imballo



TECHNICAL DETAILS / Dettagli tecnici

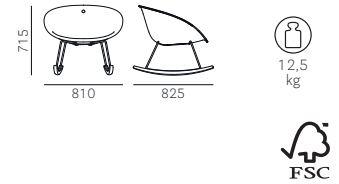

Gliss 360

LOUNGE



SEAT Sedile	BACK Schienale	POWDER COATED Verniciato	POLISHED ALUMINIUM Alluminio lucidato
TP	TP	€ 372,00	€ 452,00

TP FINISHES / Finiture TP



PACKING / Imballo



TECHNICAL DETAILS / Dettagli tecnici



Gliss 340/3

Fabric covering only
Solo vestina



SEAT Sedile	BACK Schienale	FABRIC Tessuto
C Excluding / Escluso C36+C39	C	€ 383,00
E	E	€ 574,00
G	G	€ 574,00
H Excluding / Escluso H140+H143 For technopolymer shell only Solo per scocca tecnopolimero	H	€ 397,00

For fabrics see page 325
Per i tessuti si veda a p. 325

PACKING / Imballo



TECHNICAL DETAILS / Dettagli tecnici



For colours and finishes see at page 320
Per colori e finiture vedere da pagina 320

Gliss 341

LOUNGE



SEAT Sedile	BACK Schienale	FRAME Telaio	POWDER COATED Verniciato	CHROMED Cromato
F01; F04+F09	F01; F04+F09	Ø 12	€ 1.372,00	€ 1.372,00

For fabrics see page 325
Per i tessuti si veda a p. 325

PACKING / Imballo



TECHNICAL DETAILS / Dettagli tecnici

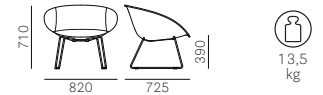

SAFETY, STRENGTH and DURABILITY TESTS
Prove di sicurezza, resistenza e durata
EN 1728:2000

Gliss 351

SWING



SEAT Sedile	BACK Schienale	FRAME Telaio	CHROMED Cromato
F01; F04+F09	F01; F04+F09	Ø 12	€ 1.492,00

For fabrics see page 325
Per i tessuti si veda a p. 325

WOODEN FINISHES / Finiture legno



FR

PACKING / Imballo



TECHNICAL DETAILS / Dettagli tecnici



Gliss 361

LOUNGE



SEAT Sedile	BACK Schienale	FRAME Telaio	POWDER COATED Verniciato	POLISHED ALUMINIUM Alluminio lucidato
F01; F04+F09	F01; F04+F09	Ø 820	€ 1.550,00	€ 1.632,00

For fabrics see page 325
Per i tessuti si veda a p. 325

PACKING / Imballo



TECHNICAL DETAILS / Dettagli tecnici

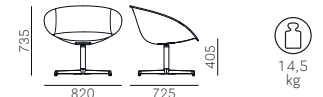

For colours and finishes see at page 320
Per colori e finiture vedere da pagina 320

Gossip 621RM



recycled polypropylene



SEAT Sedile	BACK Schienale	FRAME Telaio	POLYPROPYLENE Polipropilene
PPL	PPL	PPL	€ 84,00

PPL FINISHES / Finiture PPL



RG

PACKING / Imballo



TECHNICAL DETAILS / Dettagli tecnici



SAFETY, STRENGTH and DURABILITY TESTS
 Prove di sicurezza, resistenza e durata
 EN 1728:2012+AC2013
 EN 581-1:2017
 EN 581-2:2015+AC:2016

Gossip 621



SEAT Sedile	BACK Schienale	FRAME Telaio	POLYPROPYLENE Polipropilene
PPL	PPL	PPL	€ 84,00

PPL FINISHES / Finiture PPL



NE

SA

VE

PACKING / Imballo



TECHNICAL DETAILS / Dettagli tecnici



SAFETY, STRENGTH and DURABILITY TESTS
 Prove di sicurezza, resistenza e durata
 EN 1728:2012+AC2013
 EN 581-1:2017
 EN 581-2:2015+AC:2016

Grace 410



SEAT Sedile	BACK Schienale	FRAME Telaio	POWDER COATED Verniciato	SILVER POWDER COATED Verniciato alluminio	CHROMED Cromato	BRUSHED S/STEEL Inox satinato
PPL	PPL	Ø 16	€ 117,00 FRAME/TELAIO* White/Bianco Black/Nero Orange/Arancio	€ 124,00	€ 117,00	€ 172,00 AISI 316L

FRAME/TELAIO*
 Powder coated in the same colour of the shell / Verniciato in tinta con la scocca

PPL FINISHES / Finiture PPL



BI

NE

RO

AR

VE

PACKING / Imballo



TECHNICAL DETAILS / Dettagli tecnici

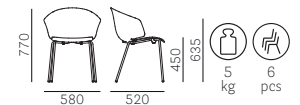

For colours and finishes see at page 320
 Per colori e finiture vedere da pagina 320



Grace 411



SEAT Sedile	BACK Schienale	FRAME Telaio	POWDER COATED Verniciato	CHROMED Cromato
PPL	PPL	Ø 11	€ 110,00 FRAME/TELAIO* White/Bianco Black/Nero Orange/Arancio	€ 110,00

FRAME/TELAIO*
Powder coated in the same colour of the shell / Verniciato in tinta con la scocca

PPL FINISHES / Finiture PPL



PACKING / Imballo



TECHNICAL DETAILS / Dettagli tecnici

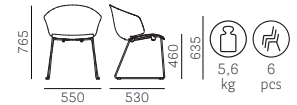

SAFETY, STRENGTH and DURABILITY TESTS
Prove di sicurezza, resistenza e durata
EN 1728:2000



Happy 490



SEAT Sedile	FRAME Telaio	POLYPROPYLENE Polipropilene
PPL	PPL H750	€ 94,00

PPL FINISHES / Finiture PPL



PACKING / Imballo



TECHNICAL DETAILS / Dettagli tecnici



SAFETY, STRENGTH and DURABILITY TESTS
Prove di sicurezza, resistenza e durata
EN 1728:2000

Happy 491



SEAT Sedile	FRAME Telaio	POLYPROPYLENE Polipropilene
PPL	PPL H450	€ 64,00

PPL FINISHES / Finiture PPL



PACKING / Imballo



TECHNICAL DETAILS / Dettagli tecnici



For colours and finishes see at page 320
Per colori e finiture vedere da pagina 320

Héra 2865



SEAT Sedile	BACK Schienale	FRAME Telaio	ASH Frassino	WALNUT (N) Noce
C Excluding / Escluso D40+D44 D120+D123	C36+C39		€ 895,00	€ 986,00
E			€ 921,00	€ 1.012,00
G	FR-AN-N	FR-AN-N	€ 962,00	€ 1.053,00
H			€ 962,00	€ 1.053,00
N			€ 903,00	€ 994,00
P			€ 981,00	€ 1.072,00
			€ 1.109,00	€ 1.200,00

For fabrics see page 325
Per i tessuti si veda a p. 325

FINISHES / Finiture



PACKING / Imballo



TECHNICAL DETAILS / Dettagli tecnici



SAFETY, STRENGTH and DURABILITY TESTS
Prove di sicurezza, resistenza e durata
EN 1728:2012+AC2013
EN 16139:2013 level 2



Héra 2869

LOUNGE



SEAT Sedile	BACK Schienale	FRAME Telaio	ASH Frassino	ASH * Frassino
C Excluding / Escluso D40+D44 D120+D123	C36+C39		€ 2.275,00	€ 2.275,00
E	N3	N3	€ 2.301,00	€ 2.301,00
G	BI-GC-AN- BL2-AZ1-	BI-GC-AN- BL2-AZ1-	€ 2.366,00	€ 2.366,00
H	VE2-VE1- RB-RA- MO-MC	VE2-VE1- RB-RA- MO-MC	€ 2.366,00	€ 2.366,00
N			€ 2.288,00	€ 2.288,00
P			€ 2.392,00	€ 2.392,00
			€ 2.548,00	€ 2.548,00

FINISHES / Finiture

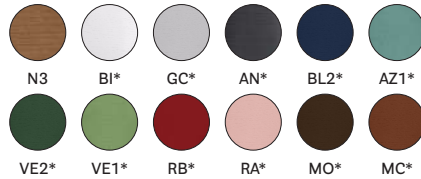

PACKING / Imballo



Lacquered with visible grains
Laccato a poro aperto

TECHNICAL DETAILS / Dettagli tecnici

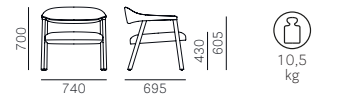

For fabrics see page 325
Per i tessuti si veda a p. 325



Host 200

Sofa unit
Divano

SEAT Sedile	BACK Schienale	FRAME Telaio	POWDER COATED Verniciato	CHROMED Cromato
C Excluding / Escluso C36+C39, C90+C95	C		€ 1.047,00	€ 1.024,00
D40+D44	D40+D44		€ 1.148,00	€ 1.125,00
E	E	Ø 16	€ 1.341,00	€ 1.317,00
G	G		€ 1.341,00	€ 1.317,00
H Excluding / Escluso H140+H143	H		€ 1.069,00	€ 1.046,00

For fabrics see page 325
Per i tessuti si veda a p. 325Couple of linking devices included
Inclusa una coppia di ganci di collegamento
(Item / Art. 200/G_NE)

PACKING / Imballo



TECHNICAL DETAILS / Dettagli tecnici

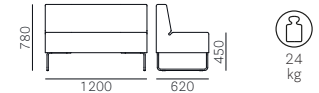

Host 201

Single seat unit
Seduta singola

SEAT Sedile	BACK Schienale	FRAME Telaio	POWDER COATED Verniciato	CHROMED Cromato
C Excluding / Escluso C36+C39, C90+C95	C		€ 648,00	€ 624,00
D40+D44	D40+D44		€ 721,00	€ 697,00
E	E	Ø 16	€ 830,00	€ 806,00
G	G		€ 830,00	€ 806,00
H Excluding / Escluso H140+H143	H		€ 662,00	€ 639,00

For fabrics see page 325
Per i tessuti si veda a p. 325Couple of linking devices included
Inclusa una coppia di ganci di collegamento
(Item / Art. 200/G_NE)

PACKING / Imballo



TECHNICAL DETAILS / Dettagli tecnici

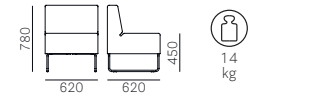

Host 202

Corner unit
Angolare

SEAT Sedile	BACK Schienale	FRAME Telaio	POWDER COATED Verniciato	CHROMED Cromato
C Excluding / Escluso C36+C39, C90+C95	C		€ 848,00	€ 825,00
D40+D44	D40+D44		€ 926,00	€ 903,00
E	E	Ø 16	€ 1.074,00	€ 1.051,00
G	G		€ 1.074,00	€ 1.051,00
H Excluding / Escluso H140+H143	H		€ 865,00	€ 842,00

For fabrics see page 325
Per i tessuti si veda a p. 325Couple of linking devices included
Inclusa una coppia di ganci di collegamento
(Item / Art. 200/G_NE)

PACKING / Imballo

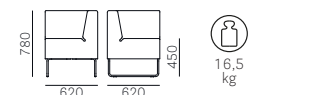

TECHNICAL DETAILS / Dettagli tecnici

For colours and finishes see at page 320
Per colori e finiture vedere da pagina 320

Host 203

Pouf



SEAT Sedile	FRAME Telaio	POWDER COATED Verniciato	CHROMED Cromato
C Excluding / Escluso C36+C39, C90+C95		€ 520,00	€ 497,00
D40+D44		€ 566,00	€ 543,00
E	Ø 16	€ 622,00	€ 598,00
G		€ 622,00	€ 598,00
H Excluding / Escluso H140+H143		€ 528,00	€ 505,00

For fabrics see page 325
Per i tessuti si veda a p. 325

Couple of linking devices included
Inclusa una coppia di ganci di collegamento
(Item / Art. 200/G_NE)

PACKING / Imballo



TECHNICAL DETAILS / Dettagli tecnici



Host 220

Sofa unit
Divano



SEAT Sedile	BACK Schienale	FRAME Telaio	POWDER COATED Verniciato	CHROMED Cromato
C Excluding / Escluso C36+C39, C90+C95	C		€ 1.164,00	€ 1.141,00
D40+D44	D40+D44		€ 1.265,00	€ 1.242,00
E	E	25x25	€ 1.456,00	€ 1.433,00
G	G		€ 1.456,00	€ 1.433,00
H Excluding / Escluso H140+H143	H		€ 1.186,00	€ 1.163,00

For fabrics see page 325
Per i tessuti si veda a p. 325

PACKING / Imballo



TECHNICAL DETAILS / Dettagli tecnici

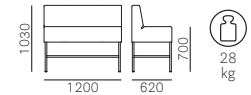

Host 221

Single seat unit
Seduta singola



SEAT Sedile	BACK Schienale	FRAME Telaio	POWDER COATED Verniciato	CHROMED Cromato
C Excluding / Escluso C36+C39, C90+C95	C		€ 695,00	€ 671,00
D40+D44	D40+D44		€ 767,00	€ 744,00
E	E	25x25	€ 877,00	€ 853,00
G	G		€ 877,00	€ 853,00
H Excluding / Escluso H140+H143	H		€ 709,00	€ 686,00

For fabrics see page 325
Per i tessuti si veda a p. 325

PACKING / Imballo



TECHNICAL DETAILS / Dettagli tecnici

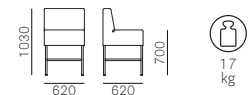

For colours and finishes see at page 320
Per colori e finiture vedere da pagina 320

Host 222

Corner unit
Angolare



SEAT Sedile	BACK Schienale	FRAME Telaio	POWDER COATED Verniciato	CHROMED Cromato
C Excluding / Escluso C36+C39, C90+C95	C	25x25	€ 895,00	€ 871,00
D40+D44	D40+D44		€ 973,00	€ 949,00
E	E		€ 1.121,00	€ 1.098,00
G	G		€ 1.121,00	€ 1.098,00
H Excluding / Escluso H140+H143	H		€ 912,00	€ 888,00

For fabrics see page 325
Per i tessuti si veda a p. 325

PACKING / Imballo



TECHNICAL DETAILS / Dettagli tecnici

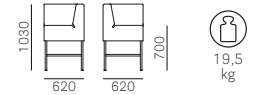

Host 223

Pouf



SEAT Sedile	FRAME Telaio	POWDER COATED Verniciato	CHROMED Cromato
C Excluding / Escluso C36+C39, C90+C95	25x25	€ 567,00	€ 544,00
D40+D44		€ 613,00	€ 589,00
E		€ 669,00	€ 645,00
G		€ 669,00	€ 645,00
H Excluding / Escluso H140+H143		€ 575,00	€ 552,00

For fabrics see page 325
Per i tessuti si veda a p. 325

PACKING / Imballo



TECHNICAL DETAILS / Dettagli tecnici



Host lounge 790



SEAT Sedile	BACK Schienale	FRAME Telaio	BRUSHED S/STEEL Inox satinato
PET	PET	Ø 16	€ 380,00 AISI 316

Couple of linking devices included / Inclusa una coppia di ganci di collegamento
(Item / Art. 790/G_NE)

PET FINISHES / Finiture PET

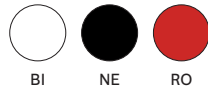

PACKING / Imballo



TECHNICAL DETAILS / Dettagli tecnici



For colours and finishes see at page 320
Per colori e finiture vedere da pagina 320

Host lounge 792



SEAT Sedile	FRAME Telaio	BRUSHED S/STEEL Inox satinato
PET	Ø 16	

€ 337,00
AISI 316

Couple of linking devices included / Inclusa una coppia di ganci di collegamento
(Item / Art. 790/G_NE)

PET FINISHES / Finiture PET

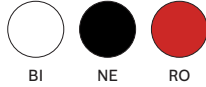

PACKING / Imballo



TECHNICAL DETAILS / Dettagli tecnici

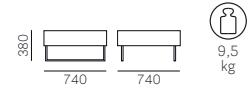

Host lounge 791



SEAT Sedile	BACK Schienale	FRAME Telaio	CHROMED Cromato
H Excluding / Escluso H140+H143	H Excluding / Escluso H140+H143	Ø 16	

€ 730,00

For fabrics see page 325
Per i tessuti si veda a p. 325

Couple of linking devices included
Inclusa una coppia di ganci di collegamento
(Item / Art. 790/G_NE)

PACKING / Imballo



TECHNICAL DETAILS / Dettagli tecnici

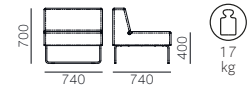

Host lounge 793



SEAT Sedile	FRAME Telaio	CHROMED Cromato
H Excluding / Escluso H140+H143	Ø 16	

€ 558,00

For fabrics see page 325
Per i tessuti si veda a p. 325

Couple of linking devices included
Inclusa una coppia di ganci di collegamento
(Item / Art. 790/G_NE)

PACKING / Imballo



TECHNICAL DETAILS / Dettagli tecnici



Ice 800



SEAT Sedile	BACK Schienale	FRAME Telaio	ANODIZED ALUMINIUM Alluminio anodizzato
PPL	PPL	Ø 28	€ 75,00

PPL FINISHES / Finiture PPL

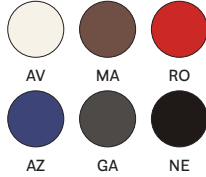

SAFETY, STRENGTH and DURABILITY TESTS
Prove di sicurezza, resistenza e durata
EN 1728:2000

PACKING / Imballo



TECHNICAL DETAILS / Dettagli tecnici



Ice 800/CL1

Fire retardant version
Versione ignifuga



SEAT Sedile	BACK Schienale	FRAME Telaio	ANODIZED ALUMINIUM Alluminio anodizzato
PPL	PPL	Ø 28	€ 106,00

Minimum order 100 pcs each colour
Ordine minimo 100 pz per colore

PPL FINISHES / Finiture PPL



SAFETY, STRENGTH and DURABILITY TESTS
Prove di sicurezza, resistenza e durata
EN 1728:2000

PACKING / Imballo



TECHNICAL DETAILS / Dettagli tecnici



Ice 850



SEAT Sedile	BACK Schienale	FRAME Telaio	ANODIZED ALUMINIUM Alluminio anodizzato
PPL	PPL	Ø 28	€ 108,00

PPL FINISHES / Finiture PPL

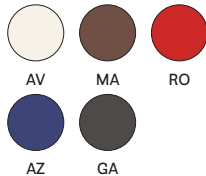

SAFETY, STRENGTH and DURABILITY TESTS
Prove di sicurezza, resistenza e durata
EN 1728:2000

PACKING / Imballo



TECHNICAL DETAILS / Dettagli tecnici

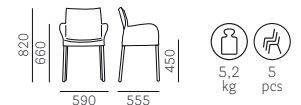

Ice 850/CL1

Fire retardant version
Versione ignifuga



SEAT Sedile	BACK Schienale	FRAME Telaio	ANODIZED ALUMINIUM Alluminio anodizzato
PPL	PPL	Ø 28	€ 143,00

Minimum order 300 pcs each colour
Ordine minimo 300 pz per colore

PPL FINISHES / Finiture PPL



PACKING / Imballo



TECHNICAL DETAILS / Dettagli tecnici

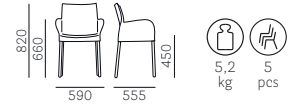

SAFETY, STRENGTH and DURABILITY TESTS
Prove di sicurezza, resistenza e durata
EN 1728:2000

Ikon 862

LOW STOOL



SEAT Sedile	FRAME Telaio	POLYPROPYLENE Polipropilene
C36+C39 C83+C89; C100+C101 C110+C122 C210+C217		€ 294,00
D40+D44	PPL	€ 315,00
G		€ 344,00
Excluding / Escluso G180+G185, G230+G239 H60+H61 H120+H127		€ 301,00

For fabrics see page 325
Per i tessuti si veda a p. 325

PPL FINISHES / Finiture PPL

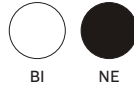

PACKING / Imballo



TECHNICAL DETAILS / Dettagli tecnici



Ikon Bench B863_1L

Single linear unit
Lineare singola

TOP Ripiano	FRAME Telaio	PRICE Prezzo
159x38CFP BIANCO	BI	€ 563,00
159x38COP NERO-247-263	NE-SA-GC	€ 468,00



Floor fixing kit (for each single base): surcharge € 101,00 (item B863_FIX)
Kit di fissaggio a terra per singola base: supplemento € 101,00 (art. B863_FIX)

PPL FINISHES / Finiture PPL

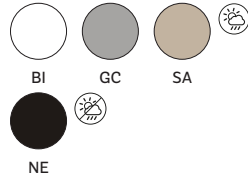

PACKING / Imballo



TECHNICAL DETAILS / Dettagli tecnici



Ikon Bench B863_1C

Single curved unit
Curva singola

TOP Ripiano	FRAME Telaio	PRICE Prezzo
R140x38CFP BIANCO	BI	€ 1.046,00
R140x38COP NERO-247-263	NE-SA-GC	€ 861,00



Floor fixing kit (for each single base): surcharge € 101,00 (item B863_FIX)
Kit di fissaggio a terra per singola base: supplemento € 101,00 (art. B863_FIX)

PPL FINISHES / Finiture PPL

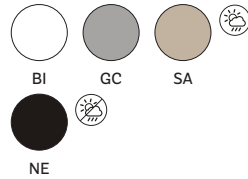

PACKING / Imballo



TECHNICAL DETAILS / Dettagli tecnici

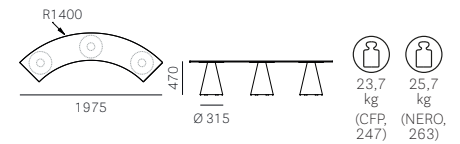

Ikon Bench B863.4

For single linear unit
Per moduli lineari

Cushion only
Solo cuscino

SEAT Sedile	PRICE Prezzo
C	€ 146,00
G	€ 218,00
H Excluding / Escluso H140+H143	€ 149,00



For fabrics see page 325
Per i tessuti si veda a p. 325

Price for single cushion
Prezzo per singolo cuscino

PACKING / Imballo



TECHNICAL DETAILS / Dettagli tecnici



Examples of IKON Bench combinations

Esempi di configurazioni IKON Bench

B863_1L

BI € 563,00
NE/SA/GC € 468,00

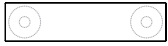

B863_2L

BI € 1.004,00
NE/SA/GC € 814,00

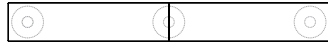

B863_3L

BI € 1.443,00
NE/SA/GC € 1.161,00

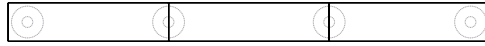

B863_4L

BI € 1.884,00
NE/SA/GC € 1.507,00

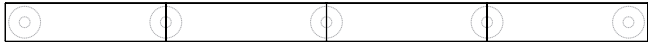

B863_4C

BI € 3.816,00
NE/SA/GC € 3.074,00

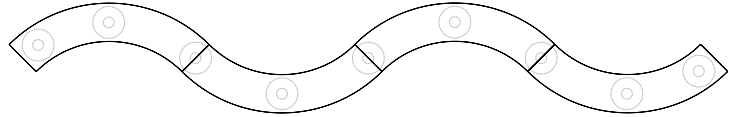

B863_1C

BI € 1.046,00
NE/SA/GC € 861,00

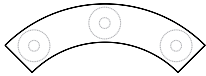

B863_2C

BI € 1.970,00
NE/SA/GC € 1.598,00

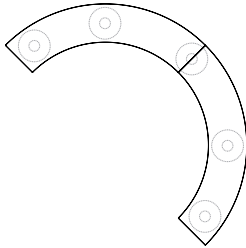

B863_3C

BI € 2.893,00
NE/SA/GC € 2.335,00

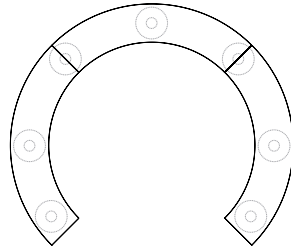

B863_LC

BI € 1.486,00
NE/SA/GC € 1.207,00

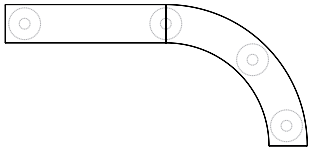

B863_LCC

BI € 2.409,00
NE/SA/GC € 1.944,00

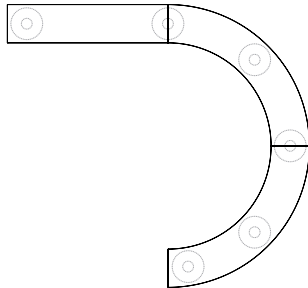

B863_CLC

BI € 2.409,00
NE/SA/GC € 1.944,00

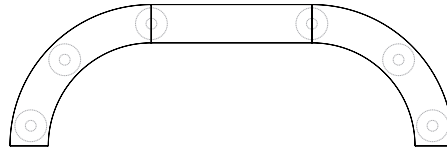

B863_LLC

BI € 1.927,00
NE/SA/GC € 1.553,00

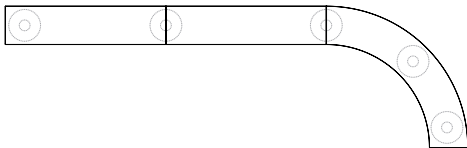

B863_LCL

BI € 1.927,00
NE/SA/GC € 1.553,00

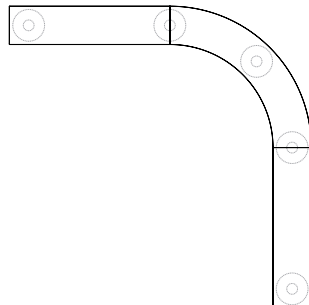

Examples of IKON Bench combinations

Esempi di configurazioni IKON Bench

B863_LLLC

BI € 2.366,00
NE/SA/GC € 1.898,00

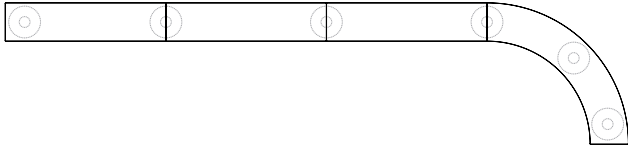

B863_LLCL

BI € 2.366,00
NE/SA/GC € 1.898,00

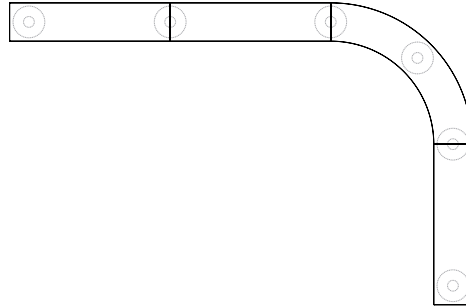

B863_CCCL

BI € 3.332,00
NE/SA/GC € 2.681,00

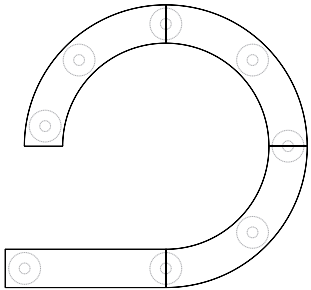

B863_CCLC

BI € 3.332,00
NE/SA/GC € 2.681,00

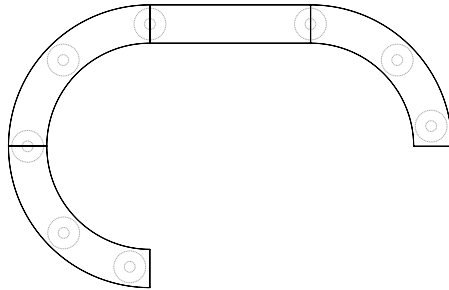

B863_CCLL

BI € 2.850,00
NE/SA/GC € 2.290,00

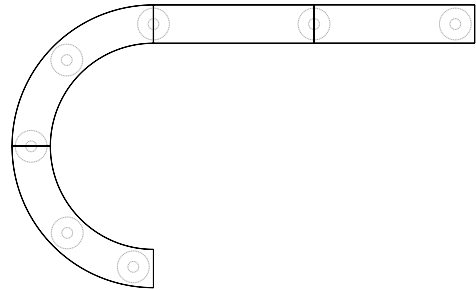

B863_LCCL

BI € 2.850,00
NE/SA/GC € 2.290,00

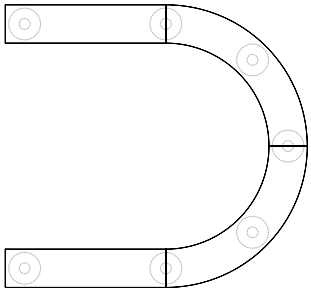

B863_CLLC

BI € 2.850,00
NE/SA/GC € 2.290,00

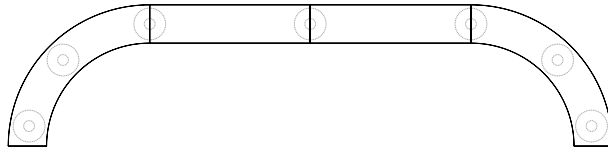

B863_CLCL

BI € 2.850,00
NE/SA/GC € 2.290,00

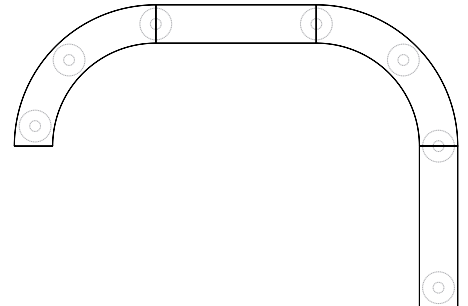

B863C_CLCCLC

BI € 4.576,00
NE/SA/GC € 3.646,00

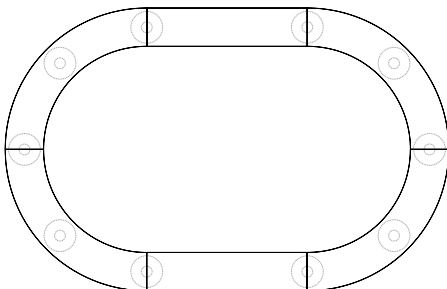

B863C_CLCLCLCL

BI € 5.458,00
NE/SA/GC € 4.339,00

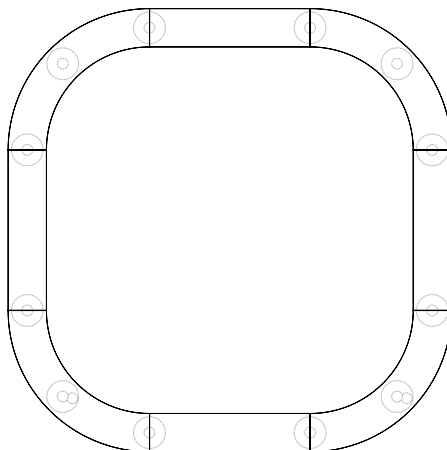

B863C_4C

BI € 3.696,00
NE/SA/GC € 2.954,00

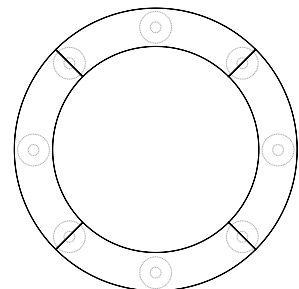

Ila 2020

LOUNGE



SEAT Sedile	BACK Schienale	FRAME Telaio	POWDER COATED Verniciato	TITANIUM Titanio
C210+C217	C210+C217	Ø 580	€ 2.239,00	€ 2.574,00
D40+D44	D40+D44		€ 2.382,00	€ 2.717,00
D120+D123	D120+D123		€ 2.782,00	€ 3.118,00
E	E		€ 2.611,00	€ 2.946,00
G	G		€ 2.782,00	€ 3.118,00
G180+G185	G180+G185		€ 2.288,00	€ 2.625,00
G230+G239	G230+G239		€ 2.460,00	€ 2.797,00
H*	H*		€ 2.711,00	€ 3.046,00
H40+H53	H40+H53		€ 3.097,00	€ 3.432,00
N*	N*			
P	P			

*Excluding / Escluso H120+H127, N20+N27

Upcharge for double-colour upholstery (fabric inner-leather outer) € 43,00
Supplemento tappezzeria bicolore (fronte tessuto-retro pelle) € 43,00For fabrics see page 325
Per i tessuti si veda a p. 325

PACKING / Imballo



TECHNICAL DETAILS / Dettagli tecnici

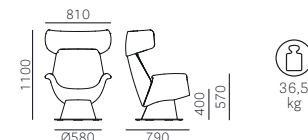

SAFETY, STRENGTH and DURABILITY TESTS

Prove di sicurezza, resistenza e durata

EN 1728:2012+AC2013

EN 16139:2013 level 2

Ila 2021

LOUNGE

Without headrest
Senza poggiatesta

SEAT Sedile	BACK Schienale	FRAME Telaio	POWDER COATED Verniciato	TITANIUM Titanio
C210+C217	C210+C217	Ø 580	€ 1.839,00	€ 2.174,00
D40+D44	D40+D44		€ 1.953,00	€ 2.288,00
D120+D123	D120+D123		€ 2.282,00	€ 2.617,00
E	E		€ 2.131,00	€ 2.468,00
G	G		€ 2.282,00	€ 2.617,00
G180+G185	G180+G185		€ 1.882,00	€ 2.217,00
G230+G239	G230+G239		€ 2.031,00	€ 2.368,00
H*	H*		€ 2.210,00	€ 2.546,00
H40+H53	H40+H53		€ 2.474,00	€ 2.811,00
N*	N*			
P	P			

*Excluding / Escluso H120+H127, N20+N27

Upcharge for double-colour upholstery (fabric inner-leather outer) € 43,00
Supplemento tappezzeria bicolore (fronte tessuto-retro pelle) € 43,00For fabrics see page 325
Per i tessuti si veda a p. 325

PACKING / Imballo

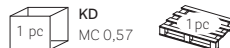

TECHNICAL DETAILS / Dettagli tecnici



SAFETY, STRENGTH and DURABILITY TESTS

Prove di sicurezza, resistenza e durata

EN 1728:2012+AC2013

EN 16139:2013 level 2

Ila 2022

LOUNGE



SEAT Sedile	BACK Schienale	FRAME Telaio	POWDER COATED Verniciato
C210+C217	C210+C217	Ø 30	€ 1.931,00
D40+D44	D40+D44		€ 2.074,00
D120+D123	D120+D123		€ 2.474,00
E	E		€ 2.303,00
G	G		€ 2.474,00
G180+G185	G180+G185		€ 1.982,00
G230+G239	G230+G239		€ 2.153,00
H*	H*		€ 2.403,00
H40+H53	H40+H53		€ 2.789,00
N*	N*		
P	P		

*Excluding / Escluso H120+H127, N20+N27

Upcharge for double-colour upholstery (fabric inner-leather outer) € 43,00
Supplemento tappezzeria bicolore (fronte tessuto-retro pelle) € 43,00For fabrics see page 325
Per i tessuti si veda a p. 325

PACKING / Imballo



TECHNICAL DETAILS / Dettagli tecnici

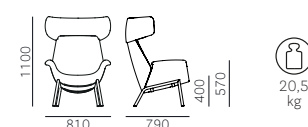

SAFETY, STRENGTH and DURABILITY TESTS

Prove di sicurezza, resistenza e durata

EN 1728:2012+AC2013

EN 16139:2013 level 2

For colours and finishes see at page 320
Per colori e finiture vedere da pagina 320

Ila 2023

LOUNGE
Without headrest
Senza poggiatesta



SEAT Sedile	BACK Schienale	FRAME Telaio	POWDER COATED Verniciato
C210+C217	C210+C217	Ø 30	€ 1.531,00
D40+D44	D40+D44		€ 1.645,00
D120+D123	D120+D123		€ 1.974,00
E	E		€ 1.824,00
G	G		€ 1.974,00
G180+G185	G180+G185		€ 1.573,00
G230+G239	G230+G239		€ 1.724,00
H*	H*		€ 1.902,00
H40+H53	H40+H53		€ 2.168,00
N*	N*		
P	P		

*Excluding / Escluso H120+H127, N20+N27

Upcharge for double-colour upholstery (fabric inner-leather outer) € 43,00
Supplemento tappezzeria bicolore (fronte tessuto-retro pelle) € 43,00

For fabrics see page 325
Per i tessuti si veda a p. 325

PACKING / Imballo



TECHNICAL DETAILS / Dettagli tecnici

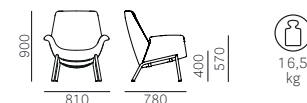

SAFETY, STRENGTH and DURABILITY TESTS

Prove di sicurezza, resistenza e durata

EN 1728:2012+AC2013

EN 16139:2013 level 2

Ila 2024

LOUNGE



SEAT Sedile	BACK Schienale	FRAME Telaio	ASH Frassino
C210+C217	C210+C217	FR-N1-AN	€ 2.074,00
D40+D44	D40+D44		€ 2.217,00
D120+D123	D120+D123		€ 2.617,00
E	E		€ 2.446,00
G	G		€ 2.617,00
G180+G185	G180+G185		€ 2.125,00
G230+G239	G230+G239		€ 2.296,00
H*	H*		€ 2.546,00
H40+H53	H40+H53		€ 2.932,00
N*	N*		
P	P		

*Excluding / Escluso H120+H127, N20+N27

Upcharge for double-colour upholstery (fabric inner-leather outer) € 43,00
Supplemento tappezzeria bicolore (fronte tessuto-retro pelle) € 43,00

FINISHES / Finiture



For fabrics see page 325
Per i tessuti si veda a p. 325

PACKING / Imballo



TECHNICAL DETAILS / Dettagli tecnici

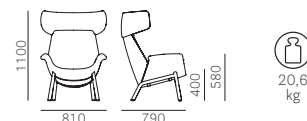

Ila 2025

LOUNGE
Without headrest
Senza poggiatesta



SEAT Sedile	BACK Schienale	FRAME Telaio	ASH Frassino
C210+C217	C210+C217	FR-N1-AN	€ 1.674,00
D40+D44	D40+D44		€ 1.788,00
D120+D123	D120+D123		€ 2.117,00
E	E		€ 1.967,00
G	G		€ 2.117,00
G180+G185	G180+G185		€ 1.716,00
G230+G239	G230+G239		€ 1.867,00
H*	H*		€ 2.045,00
H40+H53	H40+H53		€ 2.311,00
N*	N*		
P	P		

*Excluding / Escluso H120+H127, N20+N27

Upcharge for double-colour upholstery (fabric inner-leather outer) € 43,00
Supplemento tappezzeria bicolore (fronte tessuto-retro pelle) € 43,00

FINISHES / Finiture



For fabrics see page 325
Per i tessuti si veda a p. 325

PACKING / Imballo



TECHNICAL DETAILS / Dettagli tecnici



For colours and finishes see at page 320
Per colori e finiture vedere da pagina 320



Inga 5613



SEAT Sedile	BACK Schienale	FRAME Telaio	POWDER COATED Verniciato	CHROMED Cromato	ANTIQU BRASS Ottone antico
RS-W-AN	RS-W-AN	Ø 16	€ 195,00	€ 195,00	€ 294,00
V101- V102-V103	V101- V102-V103		€ 228,00	€ 228,00	€ 327,00

FINISHES / Finiture



PACKING / Imballo



TECHNICAL DETAILS / Dettagli tecnici



Inga 5619



SEAT Sedile	BACK Schienale	FRAME Telaio	POWDER COATED Verniciato	CHROMED Cromato	ANTIQU BRASS Ottone antico
RS-W-AN	RS-W-AN	Ø 10	€ 203,00	€ 195,00	€ 294,00
V101- V102-V103	V101- V102-V103		€ 237,00	€ 228,00	€ 327,00

FINISHES / Finiture



PACKING / Imballo



TECHNICAL DETAILS / Dettagli tecnici



SAFETY, STRENGTH and DURABILITY TESTS
Prove di sicurezza, resistenza e durata
EN 1728:2012+AC2013
EN 16139:2013 level 2

Inga 5663



SEAT Sedile	BACK Schienale	FRAME Telaio	POWDER COATED Verniciato	CHROMED Cromato	ANTIQU BRASS Ottone antico
F01+F09	F01+F09	Ø 16	€ 374,00	€ 374,00	€ 472,00
F11+F19	F11+F19		€ 241,00	€ 241,00	€ 340,00

Matching stitches
Cuciture in tinta

For fabrics see page 325
Per i tessuti si veda a p. 325

PACKING / Imballo



TECHNICAL DETAILS / Dettagli tecnici



For colours and finishes see at page 320
Per colori e finiture vedere da pagina 320

Inga 5669



SEAT Sedile	BACK Schienale	FRAME Telaio	POWDER COATED Verniciato	CHROMED Cromato	ANTIQU BRASS Ottone antico
F01+F09	F01+F09	Ø 10	€ 381,00	€ 374,00	€ 472,00
F11+F19	F11+F19		€ 249,00	€ 241,00	€ 340,00

Matching stitches
Cuciture in tinta

For fabrics see page 325
Per i tessuti si veda a p. 325

PACKING / Imballo



TECHNICAL DETAILS / Dettagli tecnici

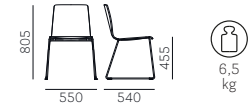

SAFETY, STRENGTH and DURABILITY TESTS
Prove di sicurezza, resistenza e durata
EN 1728:2012+AC2013
EN 16139:2013 level 2

Inga 5683



SEAT Sedile	BACK Schienale	FRAME Telaio	POWDER COATED Verniciato	CHROMED Cromato	ANTIQU BRASS Ottone antico
C Excluding / Escluso C36+C39	C	Ø 16	€ 281,00	€ 281,00	€ 380,00
D40÷D44	D40÷D44		€ 322,00	€ 322,00	€ 420,00
G	G		€ 371,00	€ 371,00	€ 470,00
H Excluding / Escluso H140+H143	H		€ 286,00	€ 286,00	€ 387,00

For fabrics see page 325
Per i tessuti si veda a p. 325

PACKING / Imballo



TECHNICAL DETAILS / Dettagli tecnici



Inga 5689



SEAT Sedile	BACK Schienale	FRAME Telaio	POWDER COATED Verniciato	CHROMED Cromato	ANTIQU BRASS Ottone antico
C Excluding / Escluso C36+C39	C	Ø 10	€ 289,00	€ 281,00	€ 380,00
D40÷D44	D40÷D44		€ 329,00	€ 322,00	€ 420,00
G	G		€ 379,00	€ 371,00	€ 470,00
H Excluding / Escluso H140+H143	H		€ 296,00	€ 286,00	€ 387,00

For fabrics see page 325
Per i tessuti si veda a p. 325

PACKING / Imballo



TECHNICAL DETAILS / Dettagli tecnici

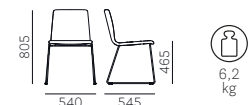

SAFETY, STRENGTH and DURABILITY TESTS
Prove di sicurezza, resistenza e durata
EN 1728:2012+AC2013
EN 16139:2013 level 2

For colours and finishes see at page 320
Per colori e finiture vedere da pagina 320

Inga 5614



SEAT Sedile	BACK Schienale	FRAME Telaio	POWDER COATED Verniciato	CHROMED Cromato	ANTIQU BRASS Ottone antico
RS-W-AN	RS-W-AN	Ø 16	€ 215,00	€ 215,00	€ 305,00
V101- V102-V103	V101- V102-V103		€ 245,00	€ 245,00	€ 335,00

FINISHES / Finiture



PACKING / Imballo



TECHNICAL DETAILS / Dettagli tecnici



Inga 5664



SEAT Sedile	BACK Schienale	FRAME Telaio	POWDER COATED Verniciato	CHROMED Cromato	ANTIQU BRASS Ottone antico
F01+F09	F01+F09	Ø 16	€ 376,00	€ 376,00	€ 467,00
F11+F19	F11+F19		€ 257,00	€ 257,00	€ 346,00

Matching stitches
Cuciture in tinta

For fabrics see page 325
Per i tessuti si veda a p. 325

PACKING / Imballo



TECHNICAL DETAILS / Dettagli tecnici



Inga 5684



SEAT Sedile	BACK Schienale	FRAME Telaio	POWDER COATED Verniciato	CHROMED Cromato	ANTIQU BRASS Ottone antico
C Excluding / Escluso C36+C39	C	Ø 16	€ 293,00	€ 293,00	€ 383,00
D40÷D44	D40÷D44		€ 329,00	€ 329,00	€ 419,00
G	G		€ 374,00	€ 374,00	€ 463,00
H Excluding / Escluso H140+H143	H		€ 298,00	€ 298,00	€ 388,00

For fabrics see page 325
Per i tessuti si veda a p. 325

PACKING / Imballo



TECHNICAL DETAILS / Dettagli tecnici

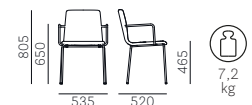

For colours and finishes see at page 320
Per colori e finiture vedere da pagina 320

Inga 5685

Upholstered armrests
Braccioli imbottiti



SEAT Sedile	BACK Schienale	FRAME Telaio	POWDER COATED Verniciato	CHROMED Cromato	ANTIQU BRASS Ottone anticato
C Excluding / Escluso C36+C39	C	Ø 16	€ 428,00	€ 428,00	€ 518,00
D40+D44	D40+D44		€ 465,00	€ 465,00	€ 554,00
G	G		€ 509,00	€ 509,00	€ 598,00
H Excluding / Escluso H140+H143	H		€ 433,00	€ 433,00	€ 523,00

For fabrics see page 325
Per i tessuti si veda a p. 325

PACKING / Imballo



TECHNICAL DETAILS / Dettagli tecnici



Inga 5616



SEAT Sedile	BACK Schienale	FRAME Telaio	POWDER COATED Verniciato	CHROMED Cromato	ANTIQU BRASS Ottone anticato
RS-W-AN	RS-W-AN	Ø 16 H670	€ 223,00	€ 223,00	€ 320,00
V101- V102-V103	V101- V102-V103		€ 253,00	€ 253,00	€ 350,00

FINISHES / Finiture



PACKING / Imballo



TECHNICAL DETAILS / Dettagli tecnici



Inga 5617



SEAT Sedile	BACK Schienale	FRAME Telaio	POWDER COATED Verniciato	CHROMED Cromato	ANTIQU BRASS Ottone anticato
RS-W-AN	RS-W-AN	Ø 16 H770	€ 225,00	€ 225,00	€ 323,00
V101- V102-V103	V101- V102-V103		€ 255,00	€ 255,00	€ 353,00

FINISHES / Finiture



PACKING / Imballo



TECHNICAL DETAILS / Dettagli tecnici



For colours and finishes see at page 320
Per colori e finiture vedere da pagina 320



Inga 5686



SEAT Sedile	BACK Schienale	FRAME Telaio	POWDER COATED Verniciato	CHROMED Cromato	ANTIQU BRASS Ottone antico
C Excluding / Escluso C36+C39	C	Ø 16 H680	€ 299,00	€ 299,00	€ 398,00
D40+D44	D40+D44		€ 337,00	€ 337,00	€ 427,00
G	G		€ 381,00	€ 381,00	€ 479,00
H Excluding / Escluso H140+H143	H		€ 306,00	€ 306,00	€ 403,00

For fabrics see page 325
Per i tessuti si veda a p. 325

PACKING / Imballo



TECHNICAL DETAILS / Dettagli tecnici



Inga 5687



SEAT Sedile	BACK Schienale	FRAME Telaio	POWDER COATED Verniciato	CHROMED Cromato	ANTIQU BRASS Ottone antico
C Excluding / Escluso C36+C39	C	Ø 16 H780	€ 303,00	€ 303,00	€ 401,00
D40+D44	D40+D44		€ 340,00	€ 340,00	€ 431,00
G	G		€ 384,00	€ 384,00	€ 481,00
H Excluding / Escluso H140+H143	H		€ 309,00	€ 309,00	€ 406,00

For fabrics see page 325
Per i tessuti si veda a p. 325

PACKING / Imballo



TECHNICAL DETAILS / Dettagli tecnici



Inga 5681

LOUNGE



SEAT Sedile	BACK Schienale	FRAME Telaio	POWDER COATED Verniciato	CHROMED Cromato
C Excluding / Escluso C36+C39	C	Ø 16	€ 432,00	€ 432,00
D40+D44	D40+D44		€ 472,00	€ 472,00
G	G		€ 537,00	€ 537,00
H Excluding / Escluso H140+H143	H		€ 449,00	€ 449,00

For fabrics see page 325
Per i tessuti si veda a p. 325

PACKING / Imballo



TECHNICAL DETAILS / Dettagli tecnici



For colours and finishes see at page 320
Per colori e finiture vedere da pagina 320

Inga 5688

LOUNGE



SEAT Sedile	BACK Schienale	FRAME Telaio	POWDER COATED Verniciato	CHROMED Cromato
C Excluding / Escluso C36+C39	C	Ø 11	€ 448,00	€ 448,00
D40+D44	D40+D44		€ 488,00	€ 488,00
G	G		€ 553,00	€ 553,00
H Excluding / Escluso H140+H143	H		€ 463,00	€ 463,00

For fabrics see page 325
Per i tessuti si veda a p. 325

PACKING / Imballo



TECHNICAL DETAILS / Dettagli tecnici

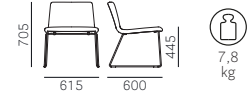

Intrigo 3715



SEAT Sedile	BACK Schienale	FRAME Telaio	POWDER COATED Verniciato
METAL	METAL	METAL	€ 366,00

FINISHES / Finiture



PACKING / Imballo



TECHNICAL DETAILS / Dettagli tecnici

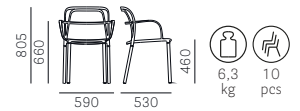

SAFETY, STRENGTH and DURABILITY TESTS
Prove di sicurezza, resistenza e durata
EN 1728:2012+AC2013
EN 16139:2013 level 2

Intrigo 3715.5

Seat cushion
Cuscino per sedile



SEAT Sedile	FABRIC Tessuto
D22+D26 D80+D89 D100+D105 D110+D114 D130	€ 116,00

For fabrics see page 325
Per i tessuti si veda a p. 325

PACKING / Imballo



TECHNICAL DETAILS / Dettagli tecnici



For colours and finishes see at page 320
Per colori e finiture vedere da pagina 320

Intrigo 3715.20

Seat + back cushion
Cuscino per sedile e schienale



SEAT Sedile	BACK Schienale	FABRIC Tessuto
D22+D26 D80+D89 D100+D105 D110+D114 D130	D22+D26 D80+D89 D100+D105 D110+D114 D130	€ 189,00

For fabrics see page 325
Per i tessuti si veda a p. 325

PACKING / Imballo



TECHNICAL DETAILS / Dettagli tecnici

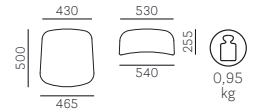

Island 795-795E



SEAT Sedile	BACK Schienale	FRAME Telaio	FABRIC Tessuto
B01+B02 C90+C95	B01+B02 C90+C95	Ø 900	€ 743,00 795
D22+D26 D80+D89 D100+D105 D110+D114 D130	D22+D26 D80+D89 D100+D105 D110+D114 D130		€ 929,00 795E

For fabrics see page 325
Per i tessuti si veda a p. 325

PACKING / Imballo



TECHNICAL DETAILS / Dettagli tecnici

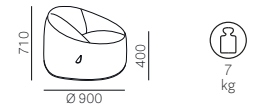

Island 796-796E



SEAT Sedile	FRAME Telaio	FABRIC Tessuto
B01+B02 C90+C95	Ø 650	€ 403,00 796
D22+D26 D80+D89 D100+D105 D110+D114 D130		€ 465,00 796E

For fabrics see page 325
Per i tessuti si veda a p. 325

PACKING / Imballo



TECHNICAL DETAILS / Dettagli tecnici



Island 797-797E



SEAT Sedile	FRAME Telaio	FABRIC Tessuto
B01+B02 C90+C95	Ø 900	€ 537,00 797
D22+D26 D80+D89 D100+D105 D110+D114 D130		€ 670,00 797E 

For fabrics see page 325
Per i tessuti si veda a p. 325

PACKING / Imballo



TECHNICAL DETAILS / Dettagli tecnici



Jamaica 2910



SEAT Sedile	BACK Schienale	FRAME Telaio	POWDER COATED Verniciato	GOLD LACQUERED Laccato oro	BLACK NICKEL Nichel nero	ANTIQU BRASS Ottone anticato
FR-AN	FR-AN	FR-AN	€ 393,00	€ 442,00	€ 465,00	€ 465,00

FINISHES / Finiture



PACKING / Imballo



TECHNICAL DETAILS / Dettagli tecnici

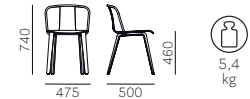

SAFETY, STRENGTH and DURABILITY TESTS
Prove di sicurezza, resistenza e durata
EN 1728:2012+AC2013
EN 16139:2013 level 2



Jamaica 2911



SEAT Sedile	BACK Schienale	FRAME Telaio	POWDER COATED Verniciato	GOLD LACQUERED Laccato oro	BLACK NICKEL Nichel nero	ANTIQU BRASS Ottone anticato
C Excluding / Escluso C36+C39	C	FR-AN	€ 537,00	€ 587,00	€ 609,00	€ 609,00
D40+D44	D40+D44		€ 571,00	€ 622,00	€ 643,00	€ 643,00
E	E		€ 624,00	€ 675,00	€ 696,00	€ 696,00
G	G		€ 624,00	€ 675,00	€ 696,00	€ 696,00
H Excluding / Escluso H140+H143	H		€ 550,00	€ 600,00	€ 622,00	€ 622,00
P	P		€ 808,00	€ 857,00	€ 879,00	€ 879,00

For fabrics see page 325
Per i tessuti si veda a p. 325

FINISHES / Finiture



PACKING / Imballo



TECHNICAL DETAILS / Dettagli tecnici



SAFETY, STRENGTH and DURABILITY TESTS
Prove di sicurezza, resistenza e durata
EN 1728:2012+AC2013
EN 16139:2013 level 2

For colours and finishes see at page 320
Per colori e finiture vedere da pagina 320



Jamaica 2015



SEAT Sedile	BACK Schienale	FRAME Telaio	POWDER COATED Verniciato	GOLD LACQUERED Laccato oro	BLACK NICKEL Nichel nero	ANTIQUÉ BRASS Ottone anticato
FR-AN	FR-AN	FR-AN	€ 405,00	€ 454,00	€ 476,00	€ 476,00

FINISHES / Finiture



PACKING / Imballo



TECHNICAL DETAILS / Dettagli tecnici



SAFETY, STRENGTH and DURABILITY TESTS
 Prove di sicurezza, resistenza e durata
 EN 1728:2012+AC2013
 EN 16139:2013 level 2



Jamaica 2016



SEAT Sedile	BACK Schienale	FRAME Telaio	POWDER COATED Verniciato	GOLD LACQUERED Laccato oro	BLACK NICKEL Nichel nero	ANTIQUÉ BRASS Ottone anticato
C Excluding / Escluso C36+C39 D40÷D44	C D40÷D44	FR-AN	€ 549,00	€ 598,00	€ 621,00	€ 621,00
E	E		€ 583,00	€ 634,00	€ 654,00	€ 654,00
G	G		€ 636,00	€ 686,00	€ 708,00	€ 708,00
H Excluding / Escluso H140+H143	H		€ 636,00	€ 686,00	€ 708,00	€ 708,00
P	P		€ 562,00	€ 611,00	€ 634,00	€ 634,00
			€ 819,00	€ 869,00	€ 891,00	€ 891,00

For fabrics see page 325
 Per i tessuti si veda a p. 325

FINISHES / Finiture



PACKING / Imballo



TECHNICAL DETAILS / Dettagli tecnici



SAFETY, STRENGTH and DURABILITY TESTS
 Prove di sicurezza, resistenza e durata
 EN 1728:2012+AC2013
 EN 16139:2013 level 2



Jazz 3719



SEAT Sedile	BACK Schienale	FRAME Telaio	POWDER COATED Verniciato	GOLD LACQUERED Laccato oro	BRUSHED BRONZE Bronzo satinato	ANTIQUE BRASS Ottone anticato	ANTIQUE COPPER Rame anticato	TITANIUM Titanio
C83+C89; C100+C101 C110+C122 C130+C141 C210+C217	C83+C89; C100+C101 C110+C122 C130+C141 C210+C217	Ø 16	€ 329,00	€ 394,00	€ 415,00	€ 415,00	€ 415,00	€ 415,00
D120+D123	D120+D123		€ 358,00	€ 423,00	€ 444,00	€ 444,00	€ 444,00	€ 444,00
E	E		€ 401,00	€ 466,00	€ 487,00	€ 487,00	€ 487,00	€ 487,00
G	G		€ 401,00	€ 466,00	€ 487,00	€ 487,00	€ 487,00	€ 487,00
H	H		€ 341,00	€ 406,00	€ 427,00	€ 427,00	€ 427,00	€ 427,00

For fabrics see page 325
Per i tessuti si veda a p. 325

PACKING / Imballo



TECHNICAL DETAILS / Dettagli tecnici



SAFETY, STRENGTH and DURABILITY TESTS
Prove di sicurezza, resistenza e durata
EN 1728:2012+AC2013
EN 16139:2013 level 2

Jazz 3716



SEAT Sedile	BACK Schienale	FRAME Telaio	POWDER COATED Verniciato	GOLD LACQUERED Laccato oro	BRUSHED BRONZE Bronzo satinato	ANTIQUE BRASS Ottone anticato	ANTIQUE COPPER Rame anticato	TITANIUM Titanio
C83+C89; C100+C101 C110+C122 C130+C141 C210+C217	C83+C89; C100+C101 C110+C122 C130+C141 C210+C217	Ø 16	€ 556,00	€ 647,00	€ 667,00	€ 667,00	€ 667,00	€ 667,00
D120+D123	D120+D123		€ 611,00	€ 676,00	€ 697,00	€ 697,00	€ 697,00	€ 697,00
E	E		€ 708,00	€ 797,00	€ 819,00	€ 819,00	€ 819,00	€ 819,00
G	G		€ 708,00	€ 797,00	€ 819,00	€ 819,00	€ 819,00	€ 819,00
H	H		€ 576,00	€ 666,00	€ 687,00	€ 687,00	€ 687,00	€ 687,00

For fabrics see page 325
Per i tessuti si veda a p. 325

PACKING / Imballo



TECHNICAL DETAILS / Dettagli tecnici

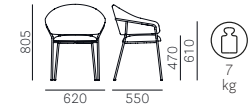

SAFETY, STRENGTH and DURABILITY TESTS
Prove di sicurezza, resistenza e durata
EN 1728:2012+AC2013
EN 16139:2013 level 2

Jazz 3717



SEAT Sedile	BACK Schienale	FRAME Telaio	POWDER COATED Verniciato	GOLD LACQUERED Laccato oro	BRUSHED BRONZE Bronzo satinato	ANTIQUE BRASS Ottone anticato	ANTIQUE COPPER Rame anticato	TITANIUM Titanio
C83+C89; C100+C101 C110+C122 C130+C141 C210+C217	C83+C89; C100+C101 C110+C122 C130+C141 C210+C217	Ø 16 H660	€ 567,00	€ 678,00	€ 721,00	€ 721,00	€ 721,00	€ 721,00
D120+D123	D120+D123		€ 619,00	€ 683,00	€ 705,00	€ 705,00	€ 705,00	€ 705,00
E	E		€ 697,00	€ 808,00	€ 851,00	€ 851,00	€ 851,00	€ 851,00
G	G		€ 697,00	€ 808,00	€ 851,00	€ 851,00	€ 851,00	€ 851,00
H	H		€ 584,00	€ 695,00	€ 738,00	€ 738,00	€ 738,00	€ 738,00

For fabrics see page 325
Per i tessuti si veda a p. 325

PACKING / Imballo



TECHNICAL DETAILS / Dettagli tecnici



For colours and finishes see at page 320
Per colori e finiture vedere da pagina 320

Jazz 3718

VAT NOT INCLUDED / Iva esclusa

Seating / Sedute



SEAT Sedile	BACK Schienale	FRAME Telaio	POWDER COATED Verniciato	GOLD LACQUERED Laccato oro	BRUSHED BRONZE Bronzo satinato	ANTIQUE BRASS Ottone anticato	ANTIQUE COPPER Rame anticato	TITANIUM Titanio
C83+C89; C100+C101 C110+C122 C130+C141 C210+C217	C83+C89; C100+C101 C110+C122 C130+C141 C210+C217	Ø 16 H760	€ 570,00	€ 680,00	€ 723,00	€ 723,00	€ 723,00	€ 723,00
D120+D123	D120+D123		€ 622,00	€ 687,00	€ 708,00	€ 708,00	€ 708,00	€ 708,00
E	E		€ 700,00	€ 810,00	€ 853,00	€ 853,00	€ 853,00	€ 853,00
G	G		€ 700,00	€ 810,00	€ 853,00	€ 853,00	€ 853,00	€ 853,00
H	H		€ 587,00	€ 697,00	€ 740,00	€ 740,00	€ 740,00	€ 740,00

For fabrics see page 325
Per i tessuti si veda a p. 325

PACKING / Imballo



TECHNICAL DETAILS / Dettagli tecnici



For colours and finishes see at page 320
Per colori e finiture vedere da pagina 320



Removable lining
Rivestimento sfoderabile

CODE Codice	SEAT Sedile	BACK Schienale	FABRIC Tessuto
JEFF001 Linear without armrests Lineare senza braccioli	D120÷D123	D120÷D123	€ 4.056,00
	G *	G *	€ 4.485,00
	H140÷H143	H140÷H143	€ 3.913,00
	N01÷N08 N30÷N38	N01÷N08 N30÷N38	€ 4.693,00
JEFF002 Linear with right armrest Lineare con bracciolo DX	D120÷D123	D120÷D123	€ 5.330,00
	G *	G *	€ 5.915,00
	H140÷H143	H140÷H143	€ 5.135,00
	N01÷N08 N30÷N38	N01÷N08 N30÷N38	€ 6.201,00
JEFF003 Linear with left armrest Lineare con bracciolo SX	D120÷D123	D120÷D123	€ 5.330,00
	G *	G *	€ 5.915,00
	H140÷H143	H140÷H143	€ 5.135,00
	N01÷N08 N30÷N38	N01÷N08 N30÷N38	€ 6.201,00
JEFF004 End piece with right armrest Terminale con bracciolo DX	D120÷D123	D120÷D123	€ 4.602,00
	G *	G *	€ 5.070,00
	H140÷H143	H140÷H143	€ 4.420,00
	N01÷N08 N30÷N38	N01÷N08 N30÷N38	€ 5.304,00
JEFF005 End piece with left armrest Terminale con bracciolo SX	D120÷D123	D120÷D123	€ 4.602,00
	G *	G *	€ 5.070,00
	H140÷H143	H140÷H143	€ 4.420,00
	N01÷N08 N30÷N38	N01÷N08 N30÷N38	€ 5.304,00
JEFF006 Right end piece without armrest Terminale DX senza bracciolo	D120÷D123	D120÷D123	€ 3.705,00
	G *	G *	€ 4.056,00
	H140÷H143	H140÷H143	€ 3.575,00
	N01÷N08 N30÷N38	N01÷N08 N30÷N38	€ 4.225,00
JEFF007 Left end piece without armrest Terminale SX senza bracciolo	D120÷D123	D120÷D123	€ 3.705,00
	G *	G *	€ 4.056,00
	H140÷H143	H140÷H143	€ 3.575,00
	N01÷N08 N30÷N38	N01÷N08 N30÷N38	€ 4.225,00
JEFF008 Chaise longue with right armrest Chaise longue con bracciolo DX	D120÷D123	D120÷D123	€ 4.927,00
	G *	G *	€ 5.434,00
	H140÷H143	H140÷H143	€ 4.745,00
	N01÷N08 N30÷N38	N01÷N08 N30÷N38	€ 5.681,00
JEFF009 Chaise longue with left armrest Chaise longue con bracciolo SX	D120÷D123	D120÷D123	€ 4.927,00
	G *	G *	€ 5.434,00
	H140÷H143	H140÷H143	€ 4.745,00
	N01÷N08 N30÷N38	N01÷N08 N30÷N38	€ 5.681,00
JEFF010 Corner 120° Angolare 120°	D120÷D123	D120÷D123	€ 6.877,00
	G *	G *	€ 7.553,00
	H140÷H143	H140÷H143	€ 6.617,00
	N01÷N08 N30÷N38	N01÷N08 N30÷N38	€ 7.904,00

*Excluding / Escluso G07, G100+G102, G130+G133, G150+G156, G180+G185, G200+G206, G230+G239

Optional cushions available on request see page 313
Disponibili a richiesta i cuscini accessori si veda a p. 313

For fabrics see page 325
Per i tessuti si veda a p. 325

TECHNICAL DETAILS / Dettagli tecnici

JEFF001

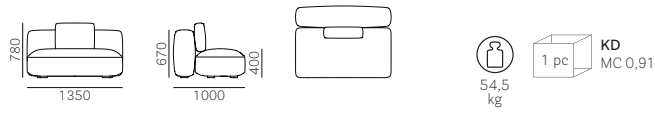

JEFF002

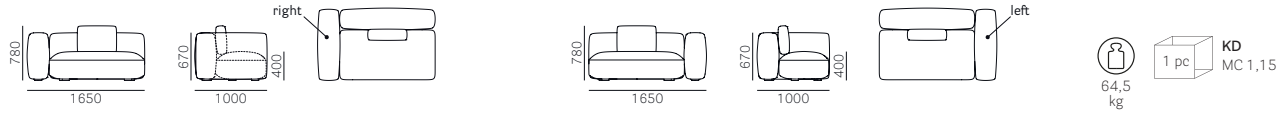

JEFF003

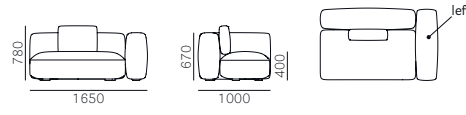

JEFF004

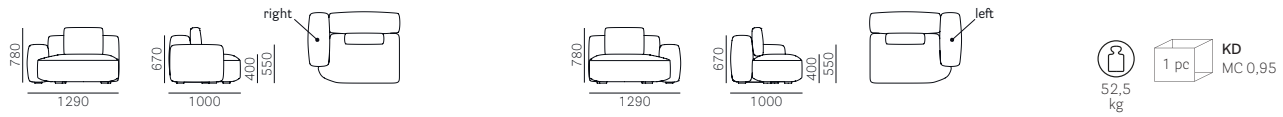

JEFF005

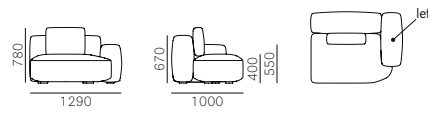

JEFF006

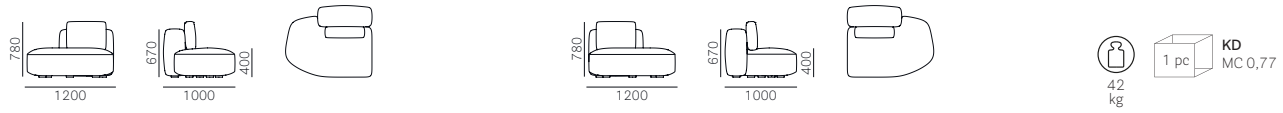

JEFF007

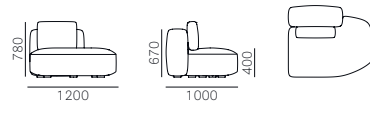

JEFF008

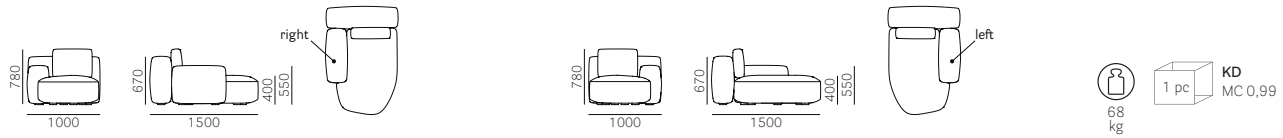

JEFF009

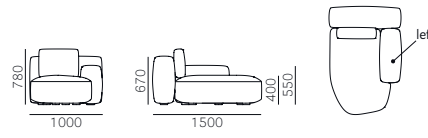

JEFF010

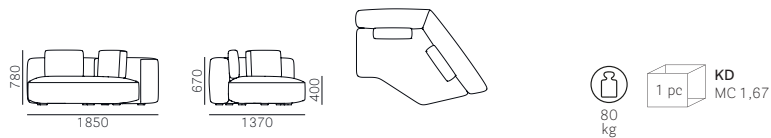

Examples of JEFF combinations

Esempi di configurazioni JEFF

JEFF004 + 005

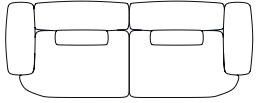

JEFF004 + 001 + 005

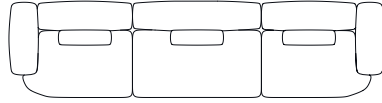

JEFF004 + 001 + 009

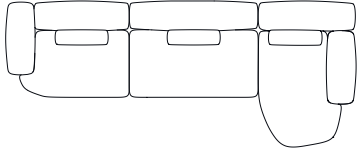

JEFF008 + 001 + 005

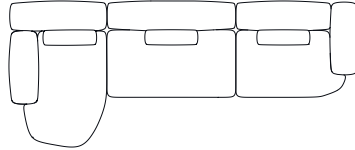

JEFF006 + 001 + 009

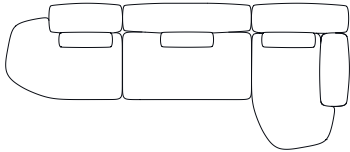

JEFF008 + 001 + 007

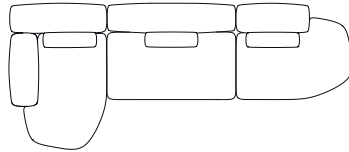

JEFF004 + 003 + 001 + 001 + 005

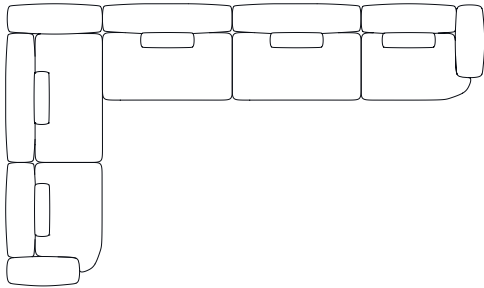

JEFF004 + 001 + 001 + 002 + 007

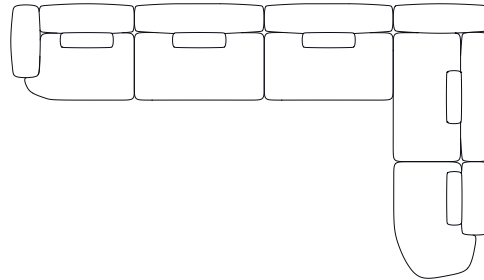

JEFF004 + 003 + 001 + 007

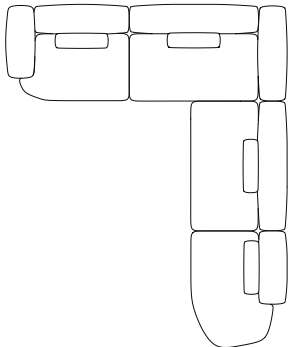

JEFF004 + 010 + 001 + 007

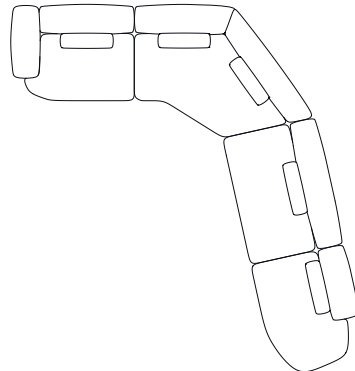

JEFF004 + 001 + 010 + 005

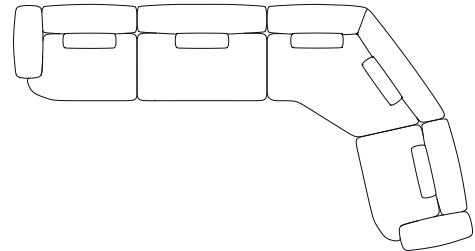

Jil 520



SEAT Sedile	BACK Schienale	FRAME Telaio
C Excluding / Escluso C36+C39	C	RS-W-N1- GC-BI
G	G	
H Excluding / Escluso H140+H143	H	
P	P	

OAK
Rovere

For fabrics see page 325
Per i tessuti si veda a p. 325

FINISHES / Finiture



W

SAFETY, STRENGTH and DURABILITY TESTS
Prove di sicurezza, resistenza e durata
EN 1728:2000

PACKING / Imballo



TECHNICAL DETAILS / Dettagli tecnici

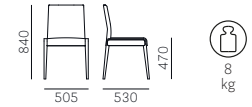

Jil 525



SEAT Sedile	BACK Schienale	FRAME Telaio
C Excluding / Escluso C36+C39	C	RS-W-N1- GC-BI
G	G	
H Excluding / Escluso H140+H143	H	
P	P	

OAK
Rovere

For fabrics see page 325
Per i tessuti si veda a p. 325

FINISHES / Finiture

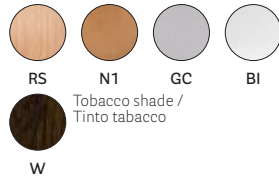

W

SAFETY, STRENGTH and DURABILITY TESTS
Prove di sicurezza, resistenza e durata
EN 1728:2000

PACKING / Imballo



TECHNICAL DETAILS / Dettagli tecnici

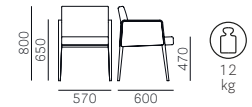

Jil 526



SEAT Sedile	BACK Schienale	FRAME Telaio
C Excluding / Escluso C36+C39	C	H780
G	G	
H Excluding / Escluso H140+H143	H	
P	P	

OAK
Rovere

For fabrics see page 325
Per i tessuti si veda a p. 325

FINISHES / Finiture



W

SAFETY, STRENGTH and DURABILITY TESTS
Prove di sicurezza, resistenza e durata
EN 1728:2000

PACKING / Imballo



TECHNICAL DETAILS / Dettagli tecnici

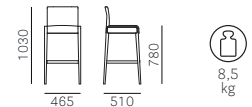

Jil 521

LOUNGE



SEAT Sedile	BACK Schienale	FRAME Telaio	OAK Rovere
C Excluding / Escluso C36+C39	C	RS-W-N1- GC-BI	€ 1.005,00
G	G		€ 1.293,00
H Excluding / Escluso H140+H143	H		€ 1.022,00
P	P		€ 1.393,00

For fabrics see page 325
Per i tessuti si veda a p. 325

FINISHES / Finiture



PACKING / Imballo



TECHNICAL DETAILS / Dettagli tecnici

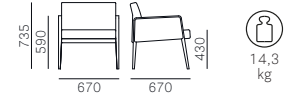

Joi 870



SEAT Sedile	BACK Schienale	FRAME Telaio	ANODIZED ALUMINIUM Alluminio anodizzato
PPL	PPL	27x27	€ 76,00

PPL FINISHES / Finiture PPL



PACKING / Imballo



TECHNICAL DETAILS / Dettagli tecnici



SAFETY, STRENGTH and DURABILITY TESTS
Prove di sicurezza, resistenza e durata
EN 1728:2000

Joi 870/CL1

Fire retardant version
Versione ignifuga



SEAT Sedile	BACK Schienale	FRAME Telaio	ANODIZED ALUMINIUM Alluminio anodizzato
PPL	PPL	27x27	€ 107,00

Minimum order 200 pcs each colour
Ordine minimo 200 pz per colore

PPL FINISHES / Finiture PPL



PACKING / Imballo



TECHNICAL DETAILS / Dettagli tecnici



SAFETY, STRENGTH and DURABILITY TESTS
Prove di sicurezza, resistenza e durata
EN 1728:2000



Koi-Booki 370



SEAT Sedile	BACK Schienale	FRAME Telaio	POWDER COATED Verniciato
PPL	PPL	22x22	€ 137,00*

FRAME/TELAIO*
Powder coated in the same colour of the shell / Verniciato in tinta con la scocca

PPL FINISHES / Finiture PPL



PACKING / Imballo



TECHNICAL DETAILS / Dettagli tecnici



SAFETY, STRENGTH and DURABILITY TESTS
Prove di sicurezza, resistenza e durata
EN 1728:2000



Koi-Booki 370/CL1

Fire retardant version
Versione ignifuga



SEAT Sedile	BACK Schienale	FRAME Telaio	WHITE POWDER COATED Verniciato bianco
PPL	PPL	22x22	€ 168,00

Minimum order 100 pcs
Ordine minimo 100 pz

PPL FINISHES / Finiture PPL



PACKING / Imballo



TECHNICAL DETAILS / Dettagli tecnici



SAFETY, STRENGTH and DURABILITY TESTS
Prove di sicurezza, resistenza e durata
EN 1728:2000

Kuadra 1101



SEAT Sedile	BACK Schienale	FRAME Telaio	POWDER COATED Verniciato	CHROMED Cromato	SATINIZED Satinato
TP	TP	20x20	€ 146,00	€ 168,00	€ 205,00

TP FINISHES / Finiture TP



PACKING / Imballo



TECHNICAL DETAILS / Dettagli tecnici



SAFETY, STRENGTH and DURABILITY TESTS
Prove di sicurezza, resistenza e durata
EN 1728:2000

Kuadra 1329/TP



SEAT Sedile	BACK Schienale	FRAME Telaio	POWDER COATED Verniciato	CHROMED Cromato	SATINIZED Satinato
TP	TP	20x20	€ 270,00	€ 292,00	€ 328,00

Chromed armrest for chromed or powder coated frame; satinized armrest for satinized frame
Bracciolo cromato per telaio cromato e verniciato; bracciolo satinato per telaio satinato

TP FINISHES / Finiture TP



PACKING / Imballo



TECHNICAL DETAILS / Dettagli tecnici

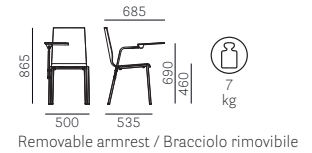

TABLET FINISHES / Finiture tavoletta

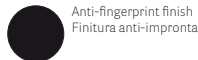

FNP_NE

Kuadra 1151



SEAT Sedile	BACK Schienale	FRAME Telaio	POWDER COATED Verniciato	CHROMED Cromato	MATT CHROMED Cromato opaco	BRUSHED S/STEEL Inox satinato
TP	TP	Ø 16	€ 103,00	€ 103,00	€ 121,00	€ 197,00

TP FINISHES / Finiture TP



PACKING / Imballo



TECHNICAL DETAILS / Dettagli tecnici



SAFETY, STRENGTH and DURABILITY TESTS
Prove di sicurezza, resistenza e durata
EN 1728:2000

For colours and finishes see at page 320
Per colori e finiture vedere da pagina 320

Kuadra 1158



SEAT Sedile	BACK Schienale	FRAME Telaio	POWDER COATED Verniciato	CHROMED Cromato
TP	TP	Ø 10	€ 119,00	€ 111,00

TP FINISHES / Finiture TP



PACKING / Imballo



TECHNICAL DETAILS / Dettagli tecnici

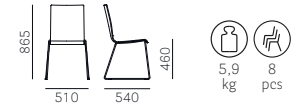

Kuadra 1271



SEAT Sedile	BACK Schienale	FRAME Telaio	POWDER COATED Verniciato	CHROMED Cromato	SATINIZED Satinato
PC	PC	20x20	€ 201,00	€ 224,00	€ 255,00

PC FINISHES / Finiture PC

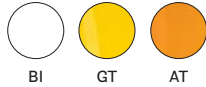

PACKING / Imballo



TECHNICAL DETAILS / Dettagli tecnici



SAFETY, STRENGTH and DURABILITY TESTS
 Prove di sicurezza, resistenza e durata
EN 1728:2000

Kuadra 1321



SEAT Sedile	BACK Schienale	FRAME Telaio	POWDER COATED Verniciato	CHROMED Cromato	SATINIZED Satinato
RS-W-AN	RS-W-AN	20x20	€ 201,00	€ 224,00	€ 263,00

FINISHES / Finiture



PACKING / Imballo



TECHNICAL DETAILS / Dettagli tecnici



SAFETY, STRENGTH and DURABILITY TESTS
Prove di sicurezza, resistenza e durata
EN 1728:2000



Kuadra 1321/A



SEAT Sedile	BACK Schienale	FRAME Telaio	POWDER COATED Verniciato	CHROMED Cromato	SATINIZED Satinato
C Excluding / Escluso C36+C39			€ 257,00	€ 280,00	€ 319,00
G	RS-W	20x20	€ 277,00	€ 299,00	€ 341,00
H Excluding / Escluso H140+H143			€ 258,00	€ 281,00	€ 320,00
P			€ 284,00	€ 306,00	€ 346,00

For fabrics see page 325
Per i tessuti si veda a p. 325

FINISHES / Finiture



PACKING / Imballo



TECHNICAL DETAILS / Dettagli tecnici

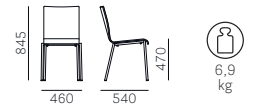

SAFETY, STRENGTH and DURABILITY TESTS
Prove di sicurezza, resistenza e durata
EN 1728:2000

Kuadra 1329



SEAT Sedile	BACK Schienale	FRAME Telaio	POWDER COATED Verniciato	CHROMED Cromato	SATINIZED Satinato
RS-W-AN	RS-W-AN	20x20	€ 325,00	€ 348,00	€ 388,00

Chromed armrest for chromed or powder coated frame; satinized armrest for satinized frame
Bracciolo cromato per telaio cromato e verniciato; bracciolo satinato per telaio satinato

FINISHES / Finiture



TABLET FINISHES / Finiture tavoletta

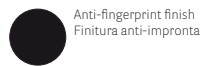

FNPN_NE

For colours and finishes see at page 320
Per colori e finiture vedere da pagina 320

PACKING / Imballo



TECHNICAL DETAILS / Dettagli tecnici

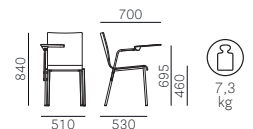

Removable armrest / Bracciolo rimovibile



Kuadra 1331



SEAT Sedile	BACK Schienale	FRAME Telaio	POWDER COATED Verniciato	CHROMED Cromato	MATT CHROMED Cromato opaco
RS-W-AN	RS-W-AN	Ø 16	€ 171,00	€ 171,00	€ 192,00

FINISHES / Finiture



PACKING / Imballo



TECHNICAL DETAILS / Dettagli tecnici



SAFETY, STRENGTH and DURABILITY TESTS
Prove di sicurezza, resistenza e durata
EN 1728:2000

Kuadra 1328



SEAT Sedile	BACK Schienale	FRAME Telaio	POWDER COATED Verniciato	CHROMED Cromato
RS-W-AN	RS-W-AN	Ø 10	€ 180,00	€ 171,00

FINISHES / Finiture



PACKING / Imballo



TECHNICAL DETAILS / Dettagli tecnici



Kuadra 1281



SEAT Sedile	BACK Schienale	FRAME Telaio	POWDER COATED Verniciato	CHROMED Cromato	MATT CHROMED Cromato opaco
F01+F09	F01+F09	Ø 16	€ 357,00	€ 357,00	€ 377,00
F11+F19	F11+F19		€ 218,00	€ 218,00	€ 240,00

For fabrics see page 325
Per i tessuti si veda a p. 325

PACKING / Imballo



TECHNICAL DETAILS / Dettagli tecnici



SAFETY, STRENGTH and DURABILITY TESTS
Prove di sicurezza, resistenza e durata
EN 1728:2000

For colours and finishes see at page 320
Per colori e finiture vedere da pagina 320

Kuadra 1291



SEAT Sedile	BACK Schienale	FRAME Telaio	POWDER COATED Verniciato	CHROMED Cromato	SATINIZED Satinato
F01+F09	F01+F09	20x20	€ 390,00	€ 414,00	€ 454,00
F11+F19	F11+F19		€ 260,00	€ 284,00	€ 315,00

For fabrics see page 325
Per i tessuti si veda a p. 325

PACKING / Imballo



TECHNICAL DETAILS / Dettagli tecnici

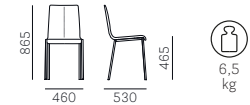

Kuadra 1298



SEAT Sedile	BACK Schienale	FRAME Telaio	POWDER COATED Verniciato	CHROMED Cromato
F01+F09	F01+F09	Ø 10	€ 364,00	€ 357,00
F11+F19	F11+F19		€ 227,00	€ 218,00

For fabrics see page 325
Per i tessuti si veda a p. 325

PACKING / Imballo



TECHNICAL DETAILS / Dettagli tecnici

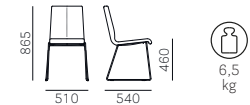

Kuadra 1010



SEAT Sedile	BACK Schienale	FRAME Telaio	POWDER COATED Verniciato	CHROMED Cromato	SATINIZED Satinato
C Excluding / Escluso C36+C39	C	20x20	€ 298,00	€ 320,00	€ 349,00
G	G		€ 375,00	€ 397,00	€ 426,00
H Excluding / Escluso H140+H143	H		€ 302,00	€ 325,00	€ 353,00

For fabrics see page 325
Per i tessuti si veda a p. 325

PACKING / Imballo



TECHNICAL DETAILS / Dettagli tecnici



SAFETY, STRENGTH and DURABILITY TESTS
Prove di sicurezza, resistenza e durata
EN 1728:2000

For colours and finishes see at page 320
Per colori e finiture vedere da pagina 320

Kuadra 1051



SEAT Sedile	BACK Schienale	FRAME Telaio	POWDER COATED Verniciato	CHROMED Cromato	MATT CHROMED Cromato opaco
C Excluding / Escluso C36+C39	C		€ 258,00	€ 258,00	€ 281,00
G	G	Ø 16	€ 336,00	€ 336,00	€ 358,00
H Excluding / Escluso H140+H143	H		€ 263,00	€ 263,00	€ 285,00

For fabrics see page 325
Per i tessuti si veda a p. 325

PACKING / Imballo



TECHNICAL DETAILS / Dettagli tecnici



SAFETY, STRENGTH and DURABILITY TESTS
Prove di sicurezza, resistenza e durata
EN 1728:2000

Kuadra 1058



SEAT Sedile	BACK Schienale	FRAME Telaio	POWDER COATED Verniciato	CHROMED Cromato
C Excluding / Escluso C36+C39	C		€ 270,00	€ 260,00
G	G	Ø 10	€ 346,00	€ 337,00
H Excluding / Escluso H140+H143	H		€ 273,00	€ 264,00

For fabrics see page 325
Per i tessuti si veda a p. 325

PACKING / Imballo



TECHNICAL DETAILS / Dettagli tecnici

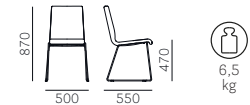

Kuadra 1102



SEAT Sedile	BACK Schienale	FRAME Telaio	POWDER COATED Verniciato	CHROMED Cromato	SATINIZED Satinato
TP	TP	20x20 H650	€ 181,00	€ 202,00	€ 237,00

TP FINISHES / Finiture TP



PACKING / Imballo



TECHNICAL DETAILS / Dettagli tecnici



For colours and finishes see at page 320
Per colori e finiture vedere da pagina 320

Kuadra 1106



SEAT Sedile	BACK Schienale	FRAME Telaio	POWDER COATED Verniciato	CHROMED Cromato	SATINIZED Satinato
TP	TP	20x20 H800	€ 212,00	€ 233,00	€ 264,00

TP FINISHES / Finiture TP



PACKING / Imballo



TECHNICAL DETAILS / Dettagli tecnici



Kuadra 1112



SEAT Sedile	BACK Schienale	FRAME Telaio	POWDER COATED Verniciato	CHROMED Cromato	MATT CHROMED Cromato opaco
TP	TP	Ø 16 H670	€ 137,00	€ 137,00	€ 155,00

TP FINISHES / Finiture TP



PACKING / Imballo



TECHNICAL DETAILS / Dettagli tecnici



SAFETY, STRENGTH and DURABILITY TESTS
Prove di sicurezza, resistenza e durata
EN 1728:2012+AC2013
EN 16139:2013 level 2

Kuadra 1116



SEAT Sedile	BACK Schienale	FRAME Telaio	POWDER COATED Verniciato	CHROMED Cromato	MATT CHROMED Cromato opaco
TP	TP	Ø 16 H770	€ 140,00	€ 140,00	€ 158,00

TP FINISHES / Finiture TP



PACKING / Imballo



TECHNICAL DETAILS / Dettagli tecnici



For colours and finishes see at page 320
Per colori e finiture vedere da pagina 320

Kuadra 1322



SEAT Sedile	BACK Schienale	FRAME Telaio	POWDER COATED Verniciato	CHROMED Cromato	SATINIZED Satinato
RS-W-AN	RS-W-AN	20x20 H650	€ 244,00	€ 264,00	€ 294,00

FINISHES / Finiture



PACKING / Imballo



TECHNICAL DETAILS / Dettagli tecnici



Kuadra 1326



SEAT Sedile	BACK Schienale	FRAME Telaio	POWDER COATED Verniciato	CHROMED Cromato	SATINIZED Satinato
RS-W-AN	RS-W-AN	20x20 H800	€ 275,00	€ 296,00	€ 327,00

FINISHES / Finiture



PACKING / Imballo



TECHNICAL DETAILS / Dettagli tecnici



Kuadra 1332



SEAT Sedile	BACK Schienale	FRAME Telaio	POWDER COATED Verniciato	CHROMED Cromato	MATT CHROMED Cromato opaco
RS-W-AN	RS-W-AN	Ø 16 H670	€ 214,00	€ 214,00	€ 233,00

FINISHES / Finiture



PACKING / Imballo



TECHNICAL DETAILS / Dettagli tecnici



For colours and finishes see at page 320
Per colori e finiture vedere da pagina 320

Kuadra 1336



SEAT Sedile	BACK Schienale	FRAME Telaio	POWDER COATED Verniciato	CHROMED Cromato	MATT CHROMED Cromato opaco
RS-W-AN	RS-W-AN	Ø 16 H770	€ 218,00	€ 218,00	€ 236,00

FINISHES / Finiture



PACKING / Imballo



TECHNICAL DETAILS / Dettagli tecnici



Kuadra 1322/F



SEAT Sedile	BACK Schienale	FRAME Telaio	POWDER COATED Verniciato	CHROMED Cromato	SATINIZED Satinato
F01+F09	F01+F09	20x20 H650	€ 394,00	€ 415,00	€ 467,00
F11+F19	F11+F19		€ 284,00	€ 305,00	€ 341,00

For fabrics see page 325
Per i tessuti si veda a p. 325

PACKING / Imballo



TECHNICAL DETAILS / Dettagli tecnici



Kuadra 1326/F



SEAT Sedile	BACK Schienale	FRAME Telaio	POWDER COATED Verniciato	CHROMED Cromato	SATINIZED Satinato
F01+F09	F01+F09	20x20 H800	€ 414,00	€ 433,00	€ 485,00
F11+F19	F11+F19		€ 315,00	€ 336,00	€ 367,00

For fabrics see page 325
Per i tessuti si veda a p. 325

PACKING / Imballo



TECHNICAL DETAILS / Dettagli tecnici



For colours and finishes see at page 320
Per colori e finiture vedere da pagina 320

Kuadra 1332/F



SEAT Sedile	BACK Schienale	FRAME Telaio	POWDER COATED Verniciato	CHROMED Cromato	MATT CHROMED Cromato opaco
F01+F09	F01+F09	Ø 16 H670	€ 353,00	€ 353,00	€ 371,00
F11+F19	F11+F19		€ 254,00	€ 254,00	€ 272,00

For fabrics see page 325
Per i tessuti si veda a p. 325

PACKING / Imballo



TECHNICAL DETAILS / Dettagli tecnici



Kuadra 1336/F



SEAT Sedile	BACK Schienale	FRAME Telaio	POWDER COATED Verniciato	CHROMED Cromato	MATT CHROMED Cromato opaco
F01+F09	F01+F09	Ø 16 H770	€ 355,00	€ 355,00	€ 375,00
F11+F19	F11+F19		€ 257,00	€ 257,00	€ 276,00

For fabrics see page 325
Per i tessuti si veda a p. 325

PACKING / Imballo



TECHNICAL DETAILS / Dettagli tecnici



Kuadra 1122



SEAT Sedile	BACK Schienale	FRAME Telaio	POWDER COATED Verniciato	CHROMED Cromato	SATINIZED Satinato
C Excluding / Escluso C36+C39	C	20x20 H670	€ 325,00	€ 346,00	€ 377,00
G	G		€ 396,00	€ 415,00	€ 448,00
H Excluding / Escluso H140+H143	H		€ 329,00	€ 350,00	€ 381,00

For fabrics see page 325
Per i tessuti si veda a p. 325

PACKING / Imballo



TECHNICAL DETAILS / Dettagli tecnici

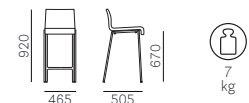

For colours and finishes see at page 320
Per colori e finiture vedere da pagina 320

Kuadra 1126



SEAT Sedile	BACK Schienale	FRAME Telaio	POWDER COATED Verniciato	CHROMED Cromato	SATINIZED Satinato
C Excluding / Escluso C36+C39	C		€ 357,00	€ 376,00	€ 407,00
G	G	20x20 H820	€ 426,00	€ 446,00	€ 479,00
H Excluding / Escluso H140+H143	H		€ 361,00	€ 381,00	€ 413,00

For fabrics see page 325
Per i tessuti si veda a p. 325

PACKING / Imballo



TECHNICAL DETAILS / Dettagli tecnici

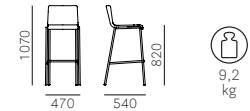

Kuadra 1132



SEAT Sedile	BACK Schienale	FRAME Telaio	POWDER COATED Verniciato	CHROMED Cromato	MATT CHROMED Cromato opaco
C Excluding / Escluso C36+C39	C		€ 281,00	€ 281,00	€ 299,00
G	G	Ø 16 H670	€ 350,00	€ 350,00	€ 370,00
H Excluding / Escluso H140+H143	H		€ 284,00	€ 284,00	€ 303,00

For fabrics see page 325
Per i tessuti si veda a p. 325

PACKING / Imballo



TECHNICAL DETAILS / Dettagli tecnici

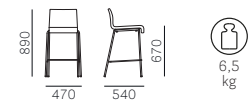

SAFETY, STRENGTH and DURABILITY TESTS
Prove di sicurezza, resistenza e durata
EN 1728:2012+AC2013
EN 16139:2013 level 2

Kuadra 1136



SEAT Sedile	BACK Schienale	FRAME Telaio	POWDER COATED Verniciato	CHROMED Cromato	MATT CHROMED Cromato opaco
C Excluding / Escluso C36+C39	C		€ 284,00	€ 284,00	€ 303,00
G	G	Ø 16 H790	€ 354,00	€ 354,00	€ 372,00
H Excluding / Escluso H140+H143	H		€ 288,00	€ 288,00	€ 306,00

For fabrics see page 325
Per i tessuti si veda a p. 325

PACKING / Imballo



TECHNICAL DETAILS / Dettagli tecnici

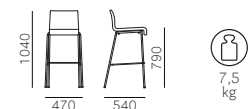

For colours and finishes see at page 320
Per colori e finiture vedere da pagina 320

Kuadra 4408



SEAT Sedile	BACK Schienale	FRAME Telaio	CHROMED Cromato	SATINIZED Satinato
RS-W-AN	RS-W-AN	400x400	€ 437,00	€ 437,00

FINISHES / Finiture



PACKING / Imballo



TECHNICAL DETAILS / Dettagli tecnici

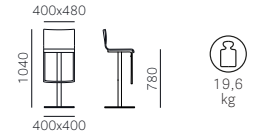

SAFETY, STRENGTH and DURABILITY TESTS
Prove di sicurezza, resistenza e durata
EN 1728:2000

Kuadra 4429



SEAT Sedile	BACK Schienale	FRAME Telaio	SATINIZED Satinato
RS-W-AN	RS-W-AN	400x400	€ 449,00

FINISHES / Finiture



PACKING / Imballo



TECHNICAL DETAILS / Dettagli tecnici

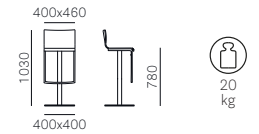

SAFETY, STRENGTH and DURABILITY TESTS
Prove di sicurezza, resistenza e durata
EN 1728:2000

Kuadra 4408/F



SEAT Sedile	BACK Schienale	FRAME Telaio	CHROMED Cromato	SATINIZED Satinato
F01+F09	F01+F09	400x400	€ 598,00	€ 598,00
F11+F19	F11+F19		€ 487,00	€ 487,00

For fabrics see page 325
Per i tessuti si veda a p. 325

PACKING / Imballo

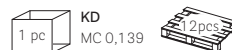

TECHNICAL DETAILS / Dettagli tecnici

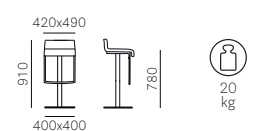

SAFETY, STRENGTH and DURABILITY TESTS
Prove di sicurezza, resistenza e durata
EN 1728:2000

Kuadra 4427/F



SEAT Sedile	BACK Schienale	FRAME Telaio	SATINIZED Satinato
F01+F09	F01+F09	400x400	€ 614,00
F11+F19	F11+F19		€ 496,00

For fabrics see page 325
Per i tessuti si veda a p. 325

PACKING / Imballo



TECHNICAL DETAILS / Dettagli tecnici

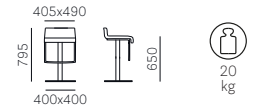

SAFETY, STRENGTH and DURABILITY TESTS
Prove di sicurezza, resistenza e durata
EN 1728:2000

Kuadra 4429/F



SEAT Sedile	BACK Schienale	FRAME Telaio	SATINIZED Satinato
F01+F09	F01+F09	400x400	€ 618,00
F11+F19	F11+F19		€ 500,00

For fabrics see page 325
Per i tessuti si veda a p. 325

PACKING / Imballo



TECHNICAL DETAILS / Dettagli tecnici

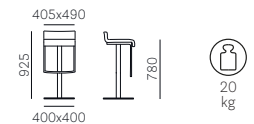

SAFETY, STRENGTH and DURABILITY TESTS
Prove di sicurezza, resistenza e durata
EN 1728:2000

Kuadra XL 2401



SEAT Sedile	BACK Schienale	FRAME Telaio	POWDER COATED Verniciato	CHROMED Cromato	SATINIZED Satinato
BI	BI	20x20	€ 149,00	€ 175,00	€ 218,00
SA-NE	SA-NE		€ 172,00	€ 198,00	€ 241,00

TP FINISHES / Finiture TP



SAFETY, STRENGTH and DURABILITY TESTS
Prove di sicurezza, resistenza e durata
EN 1728:2000

PACKING / Imballo



TECHNICAL DETAILS / Dettagli tecnici



For colours and finishes see at page 320
Per colori e finiture vedere da pagina 320

Kuadra XL 2403



SEAT Sedile	BACK Schienale	FRAME Telaio	POWDER COATED Verniciato	CHROMED Cromato
BI	BI	Ø 16	€ 111,00	€ 111,00
SA-NE	SA-NE		€ 136,00	€ 136,00

TP FINISHES / Finiture TP



PACKING / Imballo



TECHNICAL DETAILS / Dettagli tecnici



Kuadra XL 2409



SEAT Sedile	BACK Schienale	FRAME Telaio	POWDER COATED Verniciato	CHROMED Cromato
BI	BI	Ø 10	€ 127,00	€ 117,00
SA-NE	SA-NE		€ 151,00	€ 142,00

TP FINISHES / Finiture TP



PACKING / Imballo



TECHNICAL DETAILS / Dettagli tecnici



Kuadra XL 2411



SEAT Sedile	BACK Schienale	FRAME Telaio	POWDER COATED Verniciato	CHROMED Cromato	SATINIZED Satinato
RS-W-AN	RS-W-AN	20x20	€ 201,00	€ 224,00	€ 263,00

FINISHES / Finiture



PACKING / Imballo



TECHNICAL DETAILS / Dettagli tecnici



SAFETY, STRENGTH and DURABILITY TESTS
Prove di sicurezza, resistenza e durata
EN 1728:2000

For colours and finishes see at page 320
Per colori e finiture vedere da pagina 320



Kuadra XL 2413



SEAT Sedile	BACK Schienale	FRAME Telaio	POWDER COATED Verniciato	CHROMED Cromato
RS-W-AN	RS-W-AN	Ø 16	€ 171,00	€ 171,00

FINISHES / Finiture



PACKING / Imballo



TECHNICAL DETAILS / Dettagli tecnici



Kuadra XL 2411/A



SEAT Sedile	BACK Schienale	FRAME Telaio	POWDER COATED Verniciato	CHROMED Cromato	SATINIZED Satinato
C Excluding / Escluso C36+C39			€ 254,00	€ 277,00	€ 318,00
G	RS-W-AN	20x20	€ 275,00	€ 297,00	€ 337,00
H Excluding / Escluso H140+H143			€ 255,00	€ 277,00	€ 318,00
P			€ 280,00	€ 303,00	€ 342,00

For fabrics see page 325
Per i tessuti si veda a p. 325

FINISHES / Finiture



PACKING / Imballo



TECHNICAL DETAILS / Dettagli tecnici



SAFETY, STRENGTH and DURABILITY TESTS
Prove di sicurezza, resistenza e durata
EN 1728:2000

Kuadra XL 2413/A



SEAT Sedile	BACK Schienale	FRAME Telaio	POWDER COATED Verniciato	CHROMED Cromato
C Excluding / Escluso C36+C39			€ 225,00	€ 225,00
G	RS-W-AN	Ø 16	€ 245,00	€ 245,00
H Excluding / Escluso H140+H143			€ 225,00	€ 225,00
P			€ 250,00	€ 250,00

For fabrics see page 325
Per i tessuti si veda a p. 325

FINISHES / Finiture



PACKING / Imballo



TECHNICAL DETAILS / Dettagli tecnici



For colours and finishes see at page 320
Per colori e finiture vedere da pagina 320

Kuadra XL 2419



SEAT Sedile	BACK Schienale	FRAME Telaio	POWDER COATED Verniciato	CHROMED Cromato
RS-W-AN	RS-W-AN	Ø 10	€ 179,00	€ 171,00

FINISHES / Finiture



PACKING / Imballo



TECHNICAL DETAILS / Dettagli tecnici



Kuadra XL 2441



SEAT Sedile	BACK Schienale	FRAME Telaio	POWDER COATED Verniciato	CHROMED Cromato	SATINIZED Satinato
C Excluding / Escluso C36+C39	C	20x20	€ 383,00	€ 406,00	€ 446,00
G	G		€ 453,00	€ 475,00	€ 515,00
H Excluding / Escluso H140+H143	H		€ 389,00	€ 413,00	€ 453,00
P	P		€ 476,00	€ 500,00	€ 540,00

For fabrics see page 325
Per i tessuti si veda a p. 325

FINISHES / Finiture



PACKING / Imballo



TECHNICAL DETAILS / Dettagli tecnici



SAFETY, STRENGTH and DURABILITY TESTS
Prove di sicurezza, resistenza e durata
EN 1728:2000

Kuadra XL 2443



SEAT Sedile	BACK Schienale	FRAME Telaio	POWDER COATED Verniciato	CHROMED Cromato
C Excluding / Escluso C36+C39	C	Ø 16	€ 354,00	€ 354,00
G	G		€ 423,00	€ 423,00
H Excluding / Escluso H140+H143	H		€ 361,00	€ 361,00
P	P		€ 448,00	€ 448,00

For fabrics see page 325
Per i tessuti si veda a p. 325

FINISHES / Finiture



PACKING / Imballo



TECHNICAL DETAILS / Dettagli tecnici



For colours and finishes see at page 320
Per colori e finiture vedere da pagina 320

Kuada XL 2461



SEAT Sedile	BACK Schienale	FRAME Telaio	POWDER COATED Verniciato	CHROMED Cromato	SATINIZED Satinato
F01+F09	F01+F09	20x20	€ 390,00	€ 414,00	€ 454,00
F11+F19	F11+F19		€ 253,00	€ 275,00	€ 315,00

For fabrics see page 325
Per i tessuti si veda a p. 325

PACKING / Imballo



TECHNICAL DETAILS / Dettagli tecnici



Kuada XL 2463



SEAT Sedile	BACK Schienale	FRAME Telaio	POWDER COATED Verniciato	CHROMED Cromato
F01+F09	F01+F09	Ø 16	€ 357,00	€ 357,00
F11+F19	F11+F19		€ 218,00	€ 218,00

For fabrics see page 325
Per i tessuti si veda a p. 325

PACKING / Imballo



TECHNICAL DETAILS / Dettagli tecnici

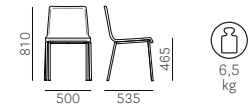

Kuada XL 2481



SEAT Sedile	BACK Schienale	FRAME Telaio	POWDER COATED Verniciato	CHROMED Cromato	SATINIZED Satinato
C Excluding / Escluso	C C36+C39	20x20	€ 335,00	€ 358,00	€ 398,00
G	G		€ 420,00	€ 442,00	€ 483,00
H Excluding / Escluso	H H140+H143		€ 341,00	€ 363,00	€ 403,00

For fabrics see page 325
Per i tessuti si veda a p. 325

PACKING / Imballo



TECHNICAL DETAILS / Dettagli tecnici

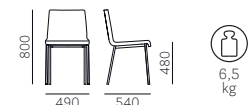

For colours and finishes see at page 320
Per colori e finiture vedere da pagina 320

Kuadra XL 2483



SEAT Sedile	BACK Schienale	FRAME Telaio	POWDER COATED Verniciato	CHROMED Cromato
C Excluding / Escluso C36+C39	C		€ 298,00	€ 298,00
G	G	Ø 16	€ 384,00	€ 384,00
H Excluding / Escluso H140+H143	H		€ 305,00	€ 305,00

For fabrics see page 325
Per i tessuti si veda a p. 325

PACKING / Imballo



TECHNICAL DETAILS / Dettagli tecnici

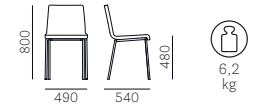

Kuadra XL 2491



SEAT Sedile	BACK Schienale	FRAME Telaio	POWDER COATED Verniciato	CHROMED Cromato	SATINIZED Satinato
C Excluding / Escluso C36+C39	C		€ 383,00	€ 405,00	€ 445,00
G	G	20x20	€ 467,00	€ 491,00	€ 530,00
H Excluding / Escluso H140+H143	H		€ 388,00	€ 410,00	€ 450,00

For fabrics see page 325
Per i tessuti si veda a p. 325

PACKING / Imballo



TECHNICAL DETAILS / Dettagli tecnici



Kuadra XL 2493



SEAT Sedile	BACK Schienale	FRAME Telaio	POWDER COATED Verniciato	CHROMED Cromato
C Excluding / Escluso C36+C39	C		€ 346,00	€ 346,00
G	G	Ø 16	€ 431,00	€ 431,00
H Excluding / Escluso H140+H143	H		€ 351,00	€ 351,00

For fabrics see page 325
Per i tessuti si veda a p. 325

PACKING / Imballo



TECHNICAL DETAILS / Dettagli tecnici



For colours and finishes see at page 320
Per colori e finiture vedere da pagina 320

Kuadra XL 2402



SEAT Sedile	BACK Schienale	FRAME Telaio	POWDER COATED Verniciato	CHROMED Cromato	SATINIZED Satinato
BI	BI	20x20	€ 192,00	€ 218,00	€ 276,00
SA-NE	SA-NE		€ 215,00	€ 241,00	€ 299,00

TP FINISHES / Finiture TP



PACKING / Imballo



TECHNICAL DETAILS / Dettagli tecnici



Kuadra XL 2404



SEAT Sedile	BACK Schienale	FRAME Telaio	POWDER COATED Verniciato	CHROMED Cromato
BI	BI	Ø 16	€ 163,00	€ 163,00
SA-NE	SA-NE		€ 172,00	€ 172,00

TP FINISHES / Finiture TP



PACKING / Imballo



TECHNICAL DETAILS / Dettagli tecnici



Kuadra XL 2412



SEAT Sedile	BACK Schienale	FRAME Telaio	POWDER COATED Verniciato	CHROMED Cromato	SATINIZED Satinato
RS-W-AN	RS-W-AN	20x20	€ 244,00	€ 268,00	€ 322,00

FINISHES / Finiture



PACKING / Imballo



TECHNICAL DETAILS / Dettagli tecnici



For colours and finishes see at page 320
Per colori e finiture vedere da pagina 320



Kuadra XL 2414



SEAT Sedile	BACK Schienale	FRAME Telaio	POWDER COATED Verniciato	CHROMED Cromato
RS-W-AN	RS-W-AN	Ø 16	€ 210,00	€ 210,00

FINISHES / Finiture



PACKING / Imballo



TECHNICAL DETAILS / Dettagli tecnici



Kuadra XL 2412/A



SEAT Sedile	BACK Schienale	FRAME Telaio	POWDER COATED Verniciato	CHROMED Cromato	SATINIZED Satinato
C Excluding / Escluso C36+C39			€ 298,00	€ 323,00	€ 376,00
G	RS-W-AN	20x20	€ 318,00	€ 342,00	€ 396,00
H Excluding / Escluso H140+H143			€ 299,00	€ 324,00	€ 377,00
P			€ 324,00	€ 348,00	€ 401,00

For fabrics see page 325
Per i tessuti si veda a p. 325

FINISHES / Finiture



PACKING / Imballo



TECHNICAL DETAILS / Dettagli tecnici



Kuadra XL 2414/A



SEAT Sedile	BACK Schienale	FRAME Telaio	POWDER COATED Verniciato	CHROMED Cromato
C Excluding / Escluso C36+C39			€ 263,00	€ 263,00
G	RS-W-AN	Ø 16	€ 283,00	€ 283,00
H Excluding / Escluso H140+H143			€ 263,00	€ 263,00
P			€ 289,00	€ 289,00

For fabrics see page 325
Per i tessuti si veda a p. 325

FINISHES / Finiture



PACKING / Imballo



TECHNICAL DETAILS / Dettagli tecnici



For colours and finishes see at page 320
Per colori e finiture vedere da pagina 320

Kuadra XL 2442



SEAT Sedile	BACK Schienale	FRAME Telaio	POWDER COATED Verniciato	CHROMED Cromato	SATINIZED Satinato
C Excluding / Escluso C36+C39	C	20x20	€ 427,00	€ 452,00	€ 505,00
G	G		€ 496,00	€ 520,00	€ 574,00
H Excluding / Escluso H140+H143	H		€ 433,00	€ 457,00	€ 511,00
P	P		€ 520,00	€ 545,00	€ 598,00

For fabrics see page 325
Per i tessuti si veda a p. 325

FINISHES / Finiture



PACKING / Imballo



TECHNICAL DETAILS / Dettagli tecnici



Kuadra XL 2444



SEAT Sedile	BACK Schienale	FRAME Telaio	POWDER COATED Verniciato	CHROMED Cromato
C Excluding / Escluso C36+C39	C	Ø 16	€ 392,00	€ 392,00
G	G		€ 461,00	€ 461,00
H Excluding / Escluso H140+H143	H		€ 398,00	€ 398,00
P	P		€ 485,00	€ 485,00

For fabrics see page 325
Per i tessuti si veda a p. 325

FINISHES / Finiture



PACKING / Imballo



TECHNICAL DETAILS / Dettagli tecnici



Kuadra XL 2462



SEAT Sedile	BACK Schienale	FRAME Telaio	POWDER COATED Verniciato	CHROMED Cromato	SATINIZED Satinato
F01+F09	F01+F09	20x20	€ 400,00	€ 424,00	€ 478,00
F11+F19	F11+F19		€ 286,00	€ 311,00	€ 364,00

For fabrics see page 325
Per i tessuti si veda a p. 325

PACKING / Imballo



TECHNICAL DETAILS / Dettagli tecnici

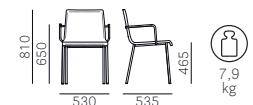

For colours and finishes see at page 320
Per colori e finiture vedere da pagina 320

Kuadra XL 2464



SEAT Sedile	BACK Schienale	FRAME Telaio	POWDER COATED Verniciato	CHROMED Cromato
F01+F09	F01+F09	Ø 16	€ 400,00	€ 400,00
F11+F19	F11+F19		€ 260,00	€ 260,00

For fabrics see page 325
Per i tessuti si veda a p. 325

PACKING / Imballo



TECHNICAL DETAILS / Dettagli tecnici



Kuadra XL 2482



SEAT Sedile	BACK Schienale	FRAME Telaio	POWDER COATED Verniciato	CHROMED Cromato	SATINIZED Satinato
C Excluding / Escluso C36+C39	C	20x20	€ 368,00	€ 392,00	€ 446,00
G	G		€ 453,00	€ 478,00	€ 531,00
H Excluding / Escluso H140+H143	H		€ 374,00	€ 398,00	€ 452,00

For fabrics see page 325
Per i tessuti si veda a p. 325

PACKING / Imballo



TECHNICAL DETAILS / Dettagli tecnici

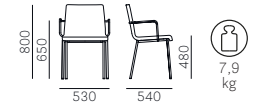

Kuadra XL 2484



SEAT Sedile	BACK Schienale	FRAME Telaio	POWDER COATED Verniciato	CHROMED Cromato
C Excluding / Escluso C36+C39	C	Ø 16	€ 329,00	€ 329,00
G	G		€ 414,00	€ 414,00
H Excluding / Escluso H140+H143	H		€ 335,00	€ 335,00

For fabrics see page 325
Per i tessuti si veda a p. 325

PACKING / Imballo



TECHNICAL DETAILS / Dettagli tecnici



For colours and finishes see at page 320
Per colori e finiture vedere da pagina 320

Kuadra XL 2492



SEAT Sedile	BACK Schienale	FRAME Telaio	POWDER COATED Verniciato	CHROMED Cromato	SATINIZED Satinato
C Excluding / Escluso C36+C39	C		€ 415,00	€ 440,00	€ 493,00
G	G	20x20	€ 500,00	€ 524,00	€ 578,00
H Excluding / Escluso H140+H143	H		€ 420,00	€ 445,00	€ 498,00

For fabrics see page 325
Per i tessuti si veda a p. 325

PACKING / Imballo



TECHNICAL DETAILS / Dettagli tecnici

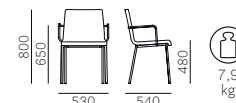

Kuadra XL 2494



SEAT Sedile	BACK Schienale	FRAME Telaio	POWDER COATED Verniciato	CHROMED Cromato
C Excluding / Escluso C36+C39	C		€ 377,00	€ 377,00
G	G	Ø 16	€ 462,00	€ 462,00
H Excluding / Escluso H140+H143	H		€ 383,00	€ 383,00

For fabrics see page 325
Per i tessuti si veda a p. 325

PACKING / Imballo



TECHNICAL DETAILS / Dettagli tecnici



Kuadra XL 4429



SEAT Sedile	BACK Schienale	FRAME Telaio	SATINIZED Satinato
C Excluding / Escluso C36+C39	C		€ 592,00
G	G	400x400	€ 680,00
H Excluding / Escluso H140+H143	H		€ 596,00

For fabrics see page 325
Per i tessuti si veda a p. 325

PACKING / Imballo



TECHNICAL DETAILS / Dettagli tecnici

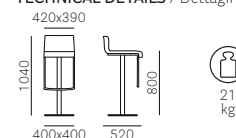

For colours and finishes see at page 320
Per colori e finiture vedere da pagina 320

Laja 883

WOOD



SEAT Sedile	BACK Schienale	FRAME Telaio	ASH Frassino
C Excluding / Escluso C36+C39	C	FR-N1-AN	€ 626,00
G	G		€ 757,00
H Excluding / Escluso H140+H143	H		€ 634,00
P	P		€ 829,00

Upcharge for double-colour upholstery (inner/outer) € 29,00
 Supplemento tappezzeria bicolore (fronte/retro) € 29,00

For fabrics see page 325
 Per i tessuti si veda a p. 325

FINISHES / Finiture



PACKING / Imballo



TECHNICAL DETAILS / Dettagli tecnici



Laja 880



SEAT Sedile	BACK Schienale	POWDER COATED Verniciato	POLISHED ALUMINIUM Alluminio lucidato
C Excluding / Escluso C36+C39	C	€ 611,00	€ 640,00
G	G	€ 743,00	€ 771,00
H Excluding / Escluso H140+H143	H	€ 619,00	€ 648,00
P	P	€ 814,00	€ 843,00

Upcharge for double-colour upholstery (inner/outer) € 29,00
 Supplemento tappezzeria bicolore (fronte/retro) € 29,00

For fabrics see page 325
 Per i tessuti si veda a p. 325

PACKING / Imballo



TECHNICAL DETAILS / Dettagli tecnici



SAFETY, STRENGTH and DURABILITY TESTS
 Prove di sicurezza, resistenza e durata
 EN 1728:2000

Laja 881



SEAT Sedile	BACK Schienale	FRAME Telaio	POWDER COATED Verniciato	CHROMED Cromato
C Excluding / Escluso C36+C39	C	Ø 12	€ 630,00	€ 630,00
G	G		€ 805,00	€ 805,00
H Excluding / Escluso H140+H143	H		€ 640,00	€ 640,00
P	P		€ 913,00	€ 913,00

Upcharge for double-colour upholstery (inner/outer) € 29,00
 Supplemento tappezzeria bicolore (fronte/retro) € 29,00

For fabrics see page 325
 Per i tessuti si veda a p. 325

PACKING / Imballo



TECHNICAL DETAILS / Dettagli tecnici

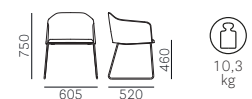

For colours and finishes see at page 320
 Per colori e finiture vedere da pagina 320

Laja 882

CANTILEVER



SEAT Sedile	BACK Schienale	FRAME Telaio	POWDER COATED Verniciato	CHROMED Cromato
C Excluding / Escluso C36+C39	C	Ø 25	€ 679,00	€ 708,00
G	G		€ 855,00	€ 883,00
H Excluding / Escluso H140+H143	H		€ 691,00	€ 719,00
P	P		€ 964,00	€ 992,00

Upcharge for double-colour upholstery (inner/outer) € 29,00
 Supplemento tappezzeria bicolore (fronte/retro) € 29,00

For fabrics see page 325
 Per i tessuti si veda a p. 325

PACKING / Imballo



TECHNICAL DETAILS / Dettagli tecnici

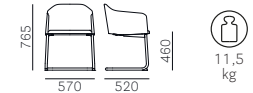

SAFETY, STRENGTH and DURABILITY TESTS

Prove di sicurezza, resistenza e durata
 EN 1728:2012+AC2013
 EN 16139:2013 level 2

Laja 884

WOOD



SEAT Sedile	BACK Schienale	FRAME Telaio	ASH Frassino
C Excluding / Escluso C36+C39	C	FR-N1-AN	€ 693,00
G	G		€ 869,00
H Excluding / Escluso H140+H143	H		€ 705,00
P	P		€ 978,00

Upcharge for double-colour upholstery (inner/outer) € 29,00
 Supplemento tappezzeria bicolore (fronte/retro) € 29,00

For fabrics see page 325
 Per i tessuti si veda a p. 325

FINISHES / Finiture



PACKING / Imballo



TECHNICAL DETAILS / Dettagli tecnici

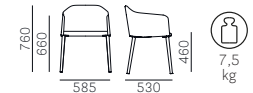

SAFETY, STRENGTH and DURABILITY TESTS

Prove di sicurezza, resistenza e durata
 EN 1728:2000

Laja 884T

WOOD



SEAT Sedile	BACK Schienale	FRAME Telaio	ASH Frassino
C Excluding / Escluso C36+C39	C	FR-N1-AN	€ 817,00
G	G		€ 992,00
H Excluding / Escluso H140+H143	H		€ 829,00
P	P		€ 1.102,00

Upcharge for double-colour upholstery (inner/outer) € 29,00
 Supplemento tappezzeria bicolore (fronte/retro) € 29,00

For fabrics see page 325
 Per i tessuti si veda a p. 325

FINISHES / Finiture



TABLET FINISHES / Finiture tavoletta

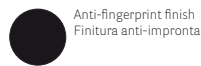

FNP_NE

For colours and finishes see at page 320
 Per colori e finiture vedere da pagina 320

PACKING / Imballo



TECHNICAL DETAILS / Dettagli tecnici



Laja 884/TT

Turning tablet only
Solo tavoletta girevoleTOP
Ripiano

€ 124,00

Black powder coated armrest Ø11 mm
Bracciolo in tondino Ø11 mm verniciato neroFor item / Per articolo
884

TABLET FINISHES / Finiture tavoletta



 Anti-fingerprint finish
Finitura anti-impronta

FNP_NE

PACKING / Imballo

 MC 0,014

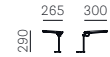
TECHNICAL DETAILS / Dettagli tecnici



 1
kg

Laja 885



SEAT Sedile	BACK Schienale	POWDER COATED Verniciato	POLISHED ALUMINIUM Alluminio lucidato
C Excluding / Escluso C36+C39	C	€ 679,00	€ 708,00
G	G	€ 855,00	€ 883,00
H Excluding / Escluso H140+H143	H	€ 691,00	€ 719,00
P	P	€ 964,00	€ 992,00

Upcharge for double-colour upholstery (inner/outer) € 29,00
Supplemento tappezzeria bicolore (fronte/retro) € 29,00For fabrics see page 325
Per i tessuti si veda a p. 325

PACKING / Imballo

 MC 0,295

TECHNICAL DETAILS / Dettagli tecnici

SAFETY, STRENGTH and DURABILITY TESTS
Prove di sicurezza, resistenza e durata
EN 1728:2000

Laja 886



SEAT Sedile	BACK Schienale	FRAME Telaio	WHITE/BLACK POWDER COATED Verniciato bianco/nero	POLISHED ALUMINIUM Alluminio lucidato
C Excluding / Escluso C36+C39	C		€ 793,00	€ 836,00
G	G	Ø 680	€ 969,00	€ 1.012,00
H Excluding / Escluso H140+H143	H		€ 805,00	€ 848,00
P	P		€ 1.078,00	€ 1.121,00

Upcharge for double-colour upholstery (inner/outer) € 29,00
Supplemento tappezzeria bicolore (fronte/retro) € 29,00For fabrics see page 325
Per i tessuti si veda a p. 325

PACKING / Imballo

 KD
MC 0,189

TECHNICAL DETAILS / Dettagli tecnici

For colours and finishes see at page 320
Per colori e finiture vedere da pagina 320

Laja 887



SEAT Sedile	BACK Schienale	FRAME Telaio	WHITE/BLACK POWDER COATED Verniciato bianco/nero	POLISHED ALUMINIUM Alluminio lucidato
C Excluding / Escluso C36+C39	C	Ø 680	€ 822,00	€ 865,00
G	G		€ 998,00	€ 1.040,00
H Excluding / Escluso H140+H143	H		€ 834,00	€ 877,00
P	P		€ 1.107,00	€ 1.150,00

Upcharge for double-colour upholstery (inner/outer) € 29,00
Supplemento tappezzeria bicolore (fronte/retro) € 29,00

For fabrics see page 325
Per i tessuti si veda a p. 325

PACKING / Imballo



TECHNICAL DETAILS / Dettagli tecnici



Laja 889G

WINGS



SEAT Sedile	BACK Schienale	FRAME Telaio	FABRIC Tessuto
C Excluding / Escluso C36+C39	C	C	€ 1.078,00
G	G	G	€ 1.259,00
H Excluding / Escluso H140+H143	H	H	€ 1.092,00
P	P	P	€ 1.572,00

Upcharge for double-colour upholstery (inner/outer) € 29,00
Supplemento tappezzeria bicolore (fronte/retro) € 29,00

For fabrics see page 325
Per i tessuti si veda a p. 325

PACKING / Imballo



TECHNICAL DETAILS / Dettagli tecnici

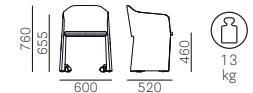

SAFETY, STRENGTH and DURABILITY TESTS
Prove di sicurezza, resistenza e durata
EN 1728:2012+AC2013
EN 16139:2013 level 2

Laja 889F

WINGS



SEAT Sedile	BACK Schienale	FRAME Telaio	FABRIC Tessuto
C Excluding / Escluso C36+C39	C	C	€ 1.035,00
G	G	G	€ 1.187,00
H Excluding / Escluso H140+H143	H	H	€ 1.050,00
P	P	P	€ 1.529,00

Upcharge for double-colour upholstery (inner/outer) € 29,00
Supplemento tappezzeria bicolore (fronte/retro) € 29,00

For fabrics see page 325
Per i tessuti si veda a p. 325

PACKING / Imballo



TECHNICAL DETAILS / Dettagli tecnici

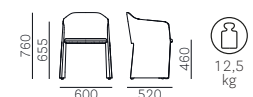

SAFETY, STRENGTH and DURABILITY TESTS
Prove di sicurezza, resistenza e durata
EN 1728:2012+AC2013
EN 16139:2013 level 2

Lamorisse 3684



SEAT Sedile	BACK Schienale	FRAME Telaio
D22+D26 D80+D89 D100+D105 D110+D114 D130	D22+D26 D80+D89 D100+D105 D110+D114 D130	METAL

POWDER COATED
Verniciato

€ 845,00

For fabrics see page 325
Per i tessuti si veda a p. 325

FINISHES / Finiture



PACKING / Imballo



TECHNICAL DETAILS / Dettagli tecnici

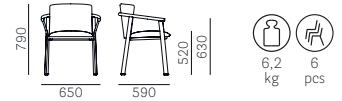

SAFETY, STRENGTH and DURABILITY TESTS
Prove di sicurezza, resistenza e durata
EN 1728:2012+AC2013
EN 16139:2013 level 2

Lamorisse 3685



SEAT Sedile	BACK Schienale	FRAME Telaio
D22+D26 D80+D89 D100+D105 D110+D114 D130	D22+D26 D80+D89 D100+D105 D110+D114 D130	METAL

POWDER COATED
Verniciato

€ 1.157,00

For fabrics see page 325
Per i tessuti si veda a p. 325

FINISHES / Finiture

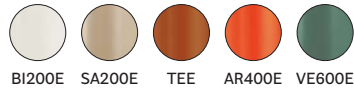

PACKING / Imballo



TECHNICAL DETAILS / Dettagli tecnici



SAFETY, STRENGTH and DURABILITY TESTS
Prove di sicurezza, resistenza e durata
EN 1728:2012+AC2013
EN 16139:2013 level 2

Leila 681



SEAT Sedile	BACK Schienale	FRAME Telaio
C Excluding / Escluso C36+C39	C	RS-W-N1- GC-BI
G	G	
H Excluding / Escluso H140+H143	H	
P	P	

OAK
Rovere

€ 762,00

€ 920,00

€ 771,00

€ 1.078,00

For fabrics see page 325
Per i tessuti si veda a p. 325

FINISHES / Finiture



PACKING / Imballo



TECHNICAL DETAILS / Dettagli tecnici

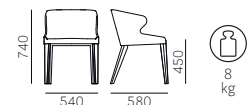

SAFETY, STRENGTH and DURABILITY TESTS
Prove di sicurezza, resistenza e durata
EN 1728:2000

Leila 682



SEAT Sedile	BACK Schienale	FRAME Telaio	CHROMED Cromato	SATINIZED Satinato
C Excluding / Escluso C36+C39	C	Ø 16	€ 669,00	€ 700,00
G	G		€ 826,00	€ 857,00
H Excluding / Escluso H140+H143	H		€ 678,00	€ 709,00
P	P		€ 985,00	€ 1.016,00

For fabrics see page 325
Per i tessuti si veda a p. 325

PACKING / Imballo



TECHNICAL DETAILS / Dettagli tecnici



Log 365



SEAT Sedile	BACK Schienale	FRAME Telaio	FABRIC Tessuto
C Excluding / Escluso C36+C39 D40÷D44 D120÷D123	C D40÷D44 D120÷D123	C D40÷D44 D120÷D123	€ 761,00
E	E	E	€ 882,00
G	G	G	€ 905,00
H	H	H	€ 905,00
N	N	N	€ 771,00
			€ 1.078,00

For fabrics see page 325
Per i tessuti si veda a p. 325

PACKING / Imballo



TECHNICAL DETAILS / Dettagli tecnici

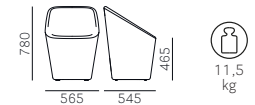

SAFETY, STRENGTH and DURABILITY TESTS
Prove di sicurezza, resistenza e durata
EN 1728:2012+AC2013
EN 16139:2013 level 2

Log 366

LOUNGE



SEAT Sedile	BACK Schienale	FRAME Telaio	FABRIC Tessuto
C Excluding / Escluso C36+C39 D40÷D44 D120÷D123	C D40÷D44 D120÷D123	C D40÷D44 D120÷D123	€ 1.011,00
E	E	E	€ 1.108,00
G	G	G	€ 1.302,00
H	H	H	€ 1.302,00
N	N	N	€ 1.029,00
			€ 1.381,00

For fabrics see page 325
Per i tessuti si veda a p. 325

PACKING / Imballo



TECHNICAL DETAILS / Dettagli tecnici

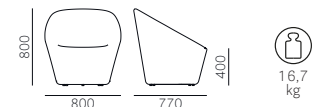

Log 367

POUF

SEAT Sedile	FRAME Telaio	FABRIC Tessuto
C Excluding / Escluso D40÷D44 D120÷D123	C C36+C39 D40÷D44 D120÷D123	€ 532,00
E	E	€ 579,00
G	G	€ 671,00
H	H	€ 671,00
N	N	€ 540,00
		€ 713,00

For fabrics see page 325
Per i tessuti si veda a p. 325



PACKING / Imballo



TECHNICAL DETAILS / Dettagli tecnici



Log 368

SOFA

SEAT Sedile	BACK Schienale	FRAME Telaio	FABRIC Tessuto
C Excluding / Escluso D40÷D44 D120÷D123	C C36+C39 D40÷D44 D120÷D123	C D40÷D44 D120÷D123	€ 1.680,00
E	E	E	€ 1.852,00
G	G	G	€ 2.113,00
H	H	H	€ 2.113,00
N	N	N	€ 1.740,00
			€ 2.238,00

For fabrics see page 325
Per i tessuti si veda a p. 325



PACKING / Imballo



TECHNICAL DETAILS / Dettagli tecnici

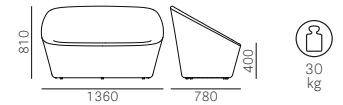

Malmö 390

SEAT Sedile	BACK Schienale	FRAME Telaio	ASH Frassino
FR-N1-GC-BI-AN	FR-N1-GC-BI-AN	FR-N1-GC-BI-AN	€ 333,00

FINISHES / Finiture



PACKING / Imballo



TECHNICAL DETAILS / Dettagli tecnici



SAFETY, STRENGTH and DURABILITY TESTS
Prove di sicurezza, resistenza e durata
EN 1728:2012+AC2013
EN 16139:2013 level 2



PRODUCT CERTIFIED
FOR LOW CHEMICAL
EMISSIONS:
UL.COM/GG
UL 2818

Malmö 390



SEAT Sedile	BACK Schienale	FRAME Telaio
BL2	BL2	BL2
AZ1	AZ1	AZ1
VE2	VE2	VE2
VE1	VE1	VE1
RB	RB	RB
RA	RA	RA
MO	MO	MO
MC	MC	MC

ASH
Frassino

€ 349,00
Lacquered with visible grains
Laccato a poro aperto

FINISHES / Finiture

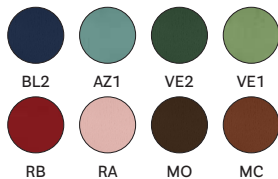

PACKING / Imballo



TECHNICAL DETAILS / Dettagli tecnici



SAFETY, STRENGTH and DURABILITY TESTS
Prove di sicurezza, resistenza e durata
EN 1728:2012+AC2013
EN 16139:2013 level 2



Malmö 392



SEAT Sedile	BACK Schienale	FRAME Telaio
F01+*F09	F01+*F09	FR-N1-GC- BI-AN

ASH
Frassino

€ 455,00

Matching stitches
Cuciture in tinta

For fabrics see page 325
Per i tessuti si veda a p. 325

FINISHES / Finiture



PACKING / Imballo



TECHNICAL DETAILS / Dettagli tecnici



SAFETY, STRENGTH and DURABILITY TESTS
Prove di sicurezza, resistenza e durata
EN 1728:2000



Malmö 391



SEAT Sedile	BACK Schienale	FRAME Telaio
C Excluding / Escluso C36+C39	C	
D40+D44	D40+D44	
D120+D123	D120+D123	
G	G	FR-N1-GC- BI-AN
H	H	
P	P	

ASH
Frassino

€ 440,00

€ 470,00

€ 519,00

€ 445,00

€ 606,00

For fabrics see page 325
Per i tessuti si veda a p. 325

FINISHES / Finiture



PACKING / Imballo



TECHNICAL DETAILS / Dettagli tecnici



SAFETY, STRENGTH and DURABILITY TESTS
Prove di sicurezza, resistenza e durata
EN 1728:2000



Malmö 395



SEAT Sedile	BACK Schienale	FRAME Telaio	ASH Frassino
FR-N1-GC-BI-AN	FR-N1-GC-BI-AN	FR-N1-GC-BI-AN	€ 384,00

FINISHES / Finiture

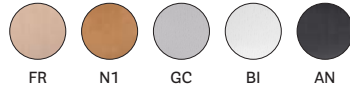

PACKING / Imballo



TECHNICAL DETAILS / Dettagli tecnici



SAFETY, STRENGTH and DURABILITY TESTS
Prove di sicurezza, resistenza e durata
EN 1728:2000



Malmö 395



SEAT Sedile	BACK Schienale	FRAME Telaio	ASH Frassino
BL2 AZ1 VE2 VE1 RB RA MO MC	BL2 AZ1 VE2 VE1 RB RA MO MC	BL2 AZ1 VE2 VE1 RB RA MO MC	€ 400,00 Lacquered with visible grains Laccato a poro aperto

FINISHES / Finiture



PACKING / Imballo



TECHNICAL DETAILS / Dettagli tecnici



SAFETY, STRENGTH and DURABILITY TESTS
Prove di sicurezza, resistenza e durata
EN 1728:2000



Malmö 397



SEAT Sedile	BACK Schienale	FRAME Telaio	ASH Frassino
F01 + F09	F01 + F09	FR-N1-GC-BI-AN	€ 554,00

Matching stitches
Cuciture in tinta
For fabrics see page 325
Per i tessuti si veda a p. 325

FINISHES / Finiture



PACKING / Imballo



TECHNICAL DETAILS / Dettagli tecnici



SAFETY, STRENGTH and DURABILITY TESTS
Prove di sicurezza, resistenza e durata
EN 1728:2000



Malmö 396



SEAT Sedile	BACK Schienale	FRAME Telaio	ASH Frassino
C Excluding / Escluso C36+C39 D40+D44 D120+D123	C D40+D44 D120+D123	FR-N1-GC- BI-AN	€ 536,00
G	G		€ 622,00
H	H		€ 543,00
P	P		€ 715,00

For fabrics see page 325
Per i tessuti si veda a p. 325

FINISHES / Finiture



PACKING / Imballo



TECHNICAL DETAILS / Dettagli tecnici



SAFETY, STRENGTH and DURABILITY TESTS
Prove di sicurezza, resistenza e durata
EN 1728:2000



Malmö 232



SEAT Sedile	BACK Schienale	FRAME Telaio	ASH Frassino	
			BRUSHED S/STEEL Inox satinato	ANTIQUE BRONZE Bronzo anticato
FR-N1-GC- BI-AN	FR-N1-GC- BI-AN	H650	€ 423,00	€ 487,00

FINISHES / Finiture



PACKING / Imballo



TECHNICAL DETAILS / Dettagli tecnici



Malmö 232



SEAT Sedile	BACK Schienale	FRAME Telaio	ASH Frassino	
			BRUSHED S/STEEL Inox satinato	ANTIQUE BRONZE Bronzo anticato
BL2 AZ1 VE2 VE1 RB RA MO MC	BL2 AZ1 VE2 VE1 RB RA MO MC	H650	€ 437,00	€ 501,00

FINISHES / Finiture



PACKING / Imballo



TECHNICAL DETAILS / Dettagli tecnici



Lacquered with visible grains
Laccato a poro aperto



PRODUCT CERTIFIED
FOR LOW CHEMICAL
EMISSIONS:
UL.COM/GG
UL 2818



PRODUCT CERTIFIED
FOR LOW CHEMICAL
EMISSIONS:
UL.COM/GG
UL 2818

Malmö 236



SEAT Sedile	BACK Schienale	FRAME Telaio	ASH Frassino	
			BRUSHED S/STEEL Inox satinato	ANTIQUE BRONZE Bronzo anticato
FR-N1-GC-BI-AN	FR-N1-GC-BI-AN	H750	€ 437,00	€ 501,00

FINISHES / Finiture



PACKING / Imballo



TECHNICAL DETAILS / Dettagli tecnici



Malmö 236



SEAT Sedile	BACK Schienale	FRAME Telaio	ASH Frassino	
			BRUSHED S/STEEL Inox satinato	ANTIQUE BRONZE Bronzo anticato
BL2 AZ1 VE2 VE1 RB RA MO MC	BL2 AZ1 VE2 VE1 RB RA MO MC	H750	€ 452,00	€ 515,00

Lacquered with visible grains
Laccato a poro aperto

FINISHES / Finiture



PACKING / Imballo



TECHNICAL DETAILS / Dettagli tecnici



Malmö 252



SEAT Sedile	BACK Schienale	FRAME Telaio	ASH Frassino	
			BRUSHED S/STEEL Inox satinato	ANTIQUE BRONZE Bronzo anticato
F01+F09	F01+F09	H655	€ 596,00	€ 661,00

Matching stitches
Cuciture in tinta

For fabrics see page 325
Per i tessuti si veda a p. 325

FINISHES / Finiture



PACKING / Imballo



TECHNICAL DETAILS / Dettagli tecnici



Malmö 256



SEAT Sedile	BACK Schienale	FRAME Telaio	ASH Frassino	
			BRUSHED S/STEEL Inox satinato	ANTIQUÉ BRONZE Bronzo anticato
F01+F09	F01+F09	H755	€ 610,00	€ 675,00

Matching stitches
Cuciture in tinta

For fabrics see page 325
Per i tessuti si veda a p. 325

FINISHES / Finiture



PACKING / Imballo



TECHNICAL DETAILS / Dettagli tecnici



Malmö 242



SEAT Sedile	BACK Schienale	FRAME Telaio	ASH Frassino	
			BRUSHED S/STEEL Inox satinato	ANTIQUÉ BRONZE Bronzo anticato
C Excluding / Escluso D40÷D44 D120÷D123	C C36+C39 D40÷D44 D120÷D123	H655	€ 579,00	€ 644,00
G	G		€ 610,00	€ 675,00
H	H		€ 660,00	€ 725,00
P	P		€ 585,00	€ 649,00
			€ 747,00	€ 812,00

For fabrics see page 325
Per i tessuti si veda a p. 325

FINISHES / Finiture



PACKING / Imballo



TECHNICAL DETAILS / Dettagli tecnici



Malmö 246



SEAT Sedile	BACK Schienale	FRAME Telaio	ASH Frassino	
			BRUSHED S/STEEL Inox satinato	ANTIQUÉ BRONZE Bronzo anticato
C Excluding / Escluso D40÷D44 D120÷D123	C C36+C39 D40÷D44 D120÷D123	H755	€ 593,00	€ 658,00
G	G		€ 624,00	€ 689,00
H	H		€ 674,00	€ 739,00
P	P		€ 600,00	€ 663,00
			€ 761,00	€ 826,00

For fabrics see page 325
Per i tessuti si veda a p. 325

FINISHES / Finiture



PACKING / Imballo



TECHNICAL DETAILS / Dettagli tecnici



Malmö

FABRIC
Tessuto



Cross stitches: surcharge **€ 43,00**
Cuciture a croce: supplemento **€ 43,00**

Simil leather, fabric (cat. G) and real leather (excluding PBS+PVE)
Finta pelle, tessuto (cat. G) e vera pelle (escluso PBS+PVE)

For fabrics see page 325
Per i tessuti si veda a p. 325

Malmö 295

LOUNGE



SEAT Sedile	BACK Schienale	FRAME Telaio	ASH Frassino
FR-N1-GC-BI-AN	FR-N1-GC-BI-AN	FR-N1-GC-BI-AN	€ 442,00

FINISHES / Finiture

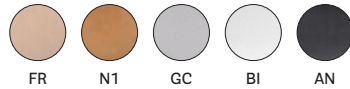

PACKING / Imballo



TECHNICAL DETAILS / Dettagli tecnici



SAFETY, STRENGTH and DURABILITY TESTS
Prove di sicurezza, resistenza e durata
EN 1728:2012+AC2013
EN 16139:2013 level 2

Malmö 295

LOUNGE



SEAT Sedile	BACK Schienale	FRAME Telaio	ASH Frassino
BL2 AZ1 VE2 VE1 RB RA MO MC	BL2 AZ1 VE2 VE1 RB RA MO MC	BL2 AZ1 VE2 VE1 RB RA MO MC	€ 457,00 Lacquered with visible grains Laccato a poro aperto

FINISHES / Finiture

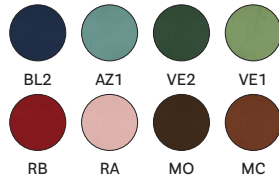

PACKING / Imballo



TECHNICAL DETAILS / Dettagli tecnici



SAFETY, STRENGTH and DURABILITY TESTS
Prove di sicurezza, resistenza e durata
EN 1728:2012+AC2013
EN 16139:2013 level 2



Malmö 297

LOUNGE



SEAT Sedile	BACK Schienale	FRAME Telaio	ASH Frassino
F01+F09	F01+F09	FR-N1-GC-BI-AN	€ 644,00

Matching stitches
Cuciture in tinta

For fabrics see page 325
Per i tessuti si veda a p. 325

FINISHES / Finiture

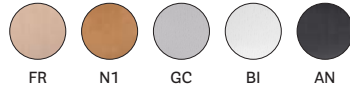

PACKING / Imballo



TECHNICAL DETAILS / Dettagli tecnici



SAFETY, STRENGTH and DURABILITY TESTS
Prove di sicurezza, resistenza e durata
EN 1728:2012+AC2013
EN 16139:2013 level 2



Malmö 296

LOUNGE



SEAT Sedile	BACK Schienale	FRAME Telaio	ASH Frassino
C Excluding / Escluso C36+C39 D40+D44 D120+D123	C D40+D44 D120+D123	FR-N1-GC-BI-AN	€ 650,00
G	G		€ 689,00
H	H		€ 753,00
P	P		€ 665,00
			€ 783,00

For fabrics see page 325
Per i tessuti si veda a p. 325

FINISHES / Finiture

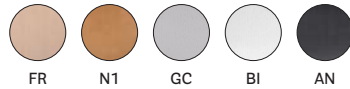

PACKING / Imballo



TECHNICAL DETAILS / Dettagli tecnici



SAFETY, STRENGTH and DURABILITY TESTS
Prove di sicurezza, resistenza e durata
EN 1728:2012+AC2013
EN 16139:2013 level 2



Malmö 299

RELAX



SEAT Sedile	BACK Schienale	FRAME Telaio	ASH Frassino
FR-N1-GC-BI-AN	FR-N1-GC-BI-AN	FR-N1-GC-BI-AN	€ 507,00

FINISHES / Finiture



PACKING / Imballo



TECHNICAL DETAILS / Dettagli tecnici



SAFETY, STRENGTH and DURABILITY TESTS
Prove di sicurezza, resistenza e durata
EN 1728:2012+AC2013
EN 16139:2013 level 2



PRODUCT CERTIFIED
FOR LOW CHEMICAL
EMISSIONS:
UL.COM/GG
UL 2818

Malmö 299

RELAX



SEAT Sedile	BACK Schienale	FRAME Telaio	ASH Frassino
BL2 AZ1 VE2 VE1 RB RA MO MC	BL2 AZ1 VE2 VE1 RB RA MO MC	BL2 AZ1 VE2 VE1 RB RA MO MC	€ 522,00 Lacquered with visible grains Laccato a poro aperto

FINISHES / Finiture



PACKING / Imballo



TECHNICAL DETAILS / Dettagli tecnici

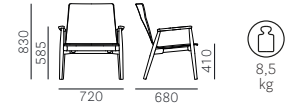

PRODUCT CERTIFIED FOR LOW CHEMICAL EMISSIONS: UL.COM/GG UL 2818

Malmö 298

RELAX



SEAT Sedile	BACK Schienale	FRAME Telaio	ASH Frassino
C Excluding / Escluso C36+C39 D40+D44 D120+D123	C D40+D44 D120+D123	FR-N1-GC- BI-AN	€ 786,00
G	G		€ 848,00
H	H		€ 942,00
P	P		€ 808,00
			€ 1.069,00

For fabrics see page 325
Per i tessuti si veda a p. 325

FINISHES / Finiture



PACKING / Imballo



TECHNICAL DETAILS / Dettagli tecnici



Modus

Linear
Lineare

MDL_110 **



MDWL_110 **



MDL_110

MDL_110_L100

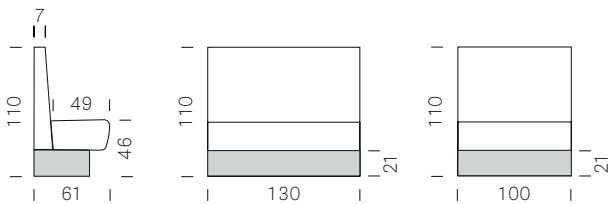

MDWL_110

MDWL_110_L100

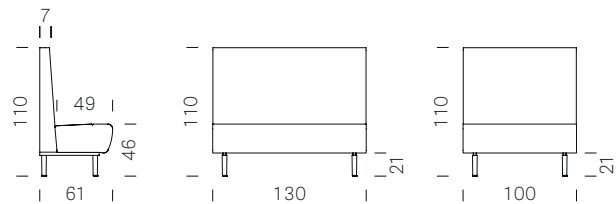

ART. MD4

Baseboard finishes available / Zoccolo disponibile nei colori

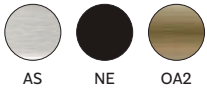

AS NE OA2

Ash wood legs / Gambe in frassino



FR N1 AN

FABRIC Tessuto	SMOOTH Liscio	BUTTONS Bottoni	CAPITONÉ Capitoné	HORIZONTAL STITCHES Cuciture orizzontali	VERTICAL STITCHES Cuciture verticali
C *	€ 1.386,00	€ 1.432,00	€ 1.644,00	€ 1.471,00	€ 1.529,00
D40+D44	€ 1.480,00	€ 1.525,00	€ 1.737,00	€ 1.564,00	€ 1.623,00
E	€ 1.674,00	€ 1.719,00	€ 1.931,00	€ 1.758,00	€ 1.817,00
G	€ 1.674,00	€ 1.719,00	€ 1.931,00	€ 1.758,00	€ 1.817,00
H *	€ 1.433,00	€ 1.479,00	€ 1.690,00	€ 1.518,00	€ 1.576,00
N	€ 1.775,00	€ 1.820,00	€ 2.032,00	€ 1.859,00	€ 1.918,00

*Excluding / Escluso C36+C39, C83+C89; C100+C101, C110+C122, H140+H143

Surcharge COUPLE SIDEBOARD L = 44 cm (item MD4/LAT_50) = € 117,00

Supplemento COPPIA ZOCCOLO LATERALE L = 44 cm (cod. MD4/LAT_50) = € 117,00

**KIT/MD2_FIX_MURO = € 26,00

Mandatory in case of a single bench resting on the wall. Recommended in case of side-by-side benches resting on the wall.
Obbligatorio in caso di panca singola che poggia a parete. Consigliato in caso di panche affiancate che poggiano a parete.The benches are suitable for wall mounting, if not we recommend to order the backside panel, see at page 186
Le panche sono adatte per utilizzo a parete. Diversamente consigliamo l'acquisto del pannello posteriore, si veda da pag. 186For fabrics see page 325
Per i tessuti si veda a p. 325Dimensions of Modus units are expressed in centimeters
Le misure dei moduli Modus sono espresse in centimetri

Modus

Linear
Lineare

MDL_140 **



MDWL_140 **

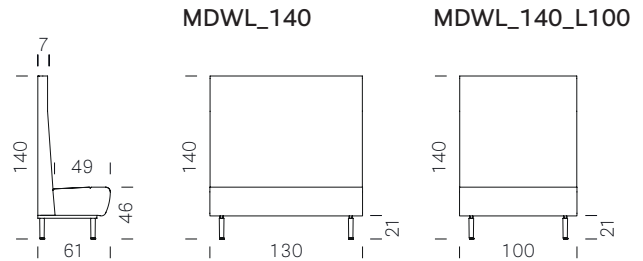
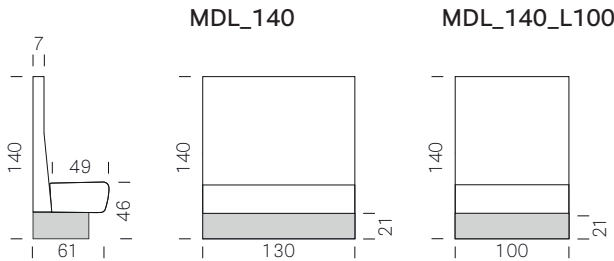

ART. MD4

Baseboard finishes available / Zoccolo disponibile nei colori



Ash wood legs / Gambe in frassino



FABRIC Tessuto	SMOOTH Liscio	BUTTONS Bottoni	CAPITONÉ Capitoné	HORIZONTAL STITCHES Cuciture orizzontali	VERTICAL STITCHES Cuciture verticali
C *	€ 1.602,00	€ 1.687,00	€ 2.060,00	€ 1.765,00	€ 1.765,00
D40+D44	€ 1.724,00	€ 1.809,00	€ 2.182,00	€ 1.887,00	€ 1.887,00
E	€ 1.880,00	€ 1.965,00	€ 2.338,00	€ 2.043,00	€ 2.043,00
G	€ 1.880,00	€ 1.965,00	€ 2.338,00	€ 2.043,00	€ 2.043,00
H *	€ 1.662,00	€ 1.746,00	€ 2.119,00	€ 1.824,00	€ 1.824,00
N	€ 2.005,00	€ 2.090,00	€ 2.463,00	€ 2.168,00	€ 2.168,00

*Excluding / Escluso C36+C39, C83+C89; C100+C101, C110+C122, H140+H143

Surcharge COUPLE SIDEBORD L = 44 cm (item MD4/LAT_50) = € 117,00
Supplemento COPPIA ZOCCOLO LATERALE L = 44 cm (cod. MD4/LAT_50) = € 117,00

**KIT/MD2_FIX_MURO = € 26,00

Mandatory in case of a single bench resting on the wall. Recommended in case of side-by-side benches resting on the wall.
Obbligatorio in caso di panca singola che poggia a parete. Consigliato in caso di panche affiancate che poggiano a parete.

The benches are suitable for wall mounting, if not we recommend to order the backside panel, see at page 186
Le panche sono adatte per utilizzo a parete. Diversamente consigliamo l'acquisto del pannello posteriore, si veda da pag. 186

For fabrics see page 325
Per i tessuti si veda a p. 325

Dimensions of Modus units are expressed in centimeters
Le misure dei moduli Modus sono espresse in centimetri

Modus

Linear
Lineare

MDL_175**

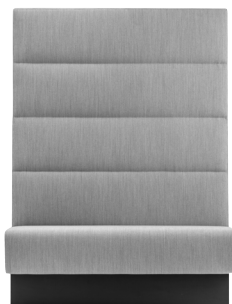

MDL_240

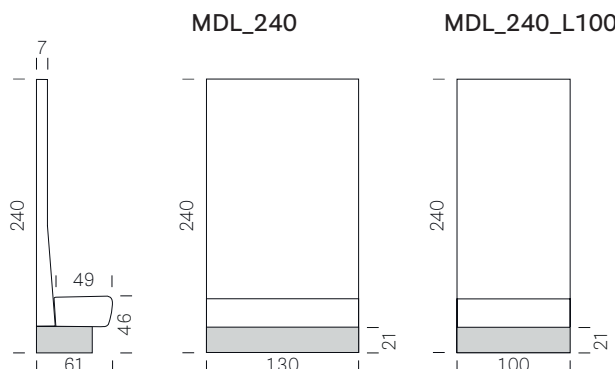

ART. MD4

Baseboard finishes available / Zoccolo disponibile nei colori



FABRIC Tessuto	SMOOTH Liscio	BUTTONS Bottoni	CAPITONÉ Capitoné	HORIZONTAL STITCHES Cuciture orizzontali
C*	€ 1.602,00	€ 1.687,00	€ 2.060,00	€ 1.765,00
D40+D44	€ 1.724,00	€ 1.809,00	€ 2.182,00	€ 1.887,00
E	€ 1.880,00	€ 1.965,00	€ 2.338,00	€ 2.043,00
G	€ 1.880,00	€ 1.965,00	€ 2.338,00	€ 2.043,00
H*	€ 1.662,00	€ 1.746,00	€ 2.119,00	€ 1.824,00
N	€ 2.005,00	€ 2.090,00	€ 2.463,00	€ 2.168,00

FABRIC Tessuto	SMOOTH Liscio	BUTTONS Bottoni	HORIZONTAL STITCHES Cuciture orizzontali
C*	€ 1.926,00	€ 2.026,00	€ 2.134,00
D40+D44	€ 2.096,00	€ 2.196,00	€ 2.304,00
E	€ 2.320,00	€ 2.420,00	€ 2.528,00
G	€ 2.320,00	€ 2.420,00	€ 2.528,00
H*	€ 2.025,00	€ 2.125,00	€ 2.233,00
N	€ 2.467,00	€ 2.567,00	€ 2.675,00

*Excluding / Escluso C36+C39, C83+C89; C100+C101, C110+C122, H140+H143

*Excluding / Escluso C36+C39, C83+C89; C100+C101, C110+C122, H140+H143

Surcharge COUPLE SIDEBORD L = 44 cm (item MD4/LAT_50) = € 117,00
Supplemento COPPIA ZOCCOLO LATERALE L = 44 cm (cod. MD4/LAT_50) = € 117,00

**KIT/MD2_FIX_MURO = € 26,00

Mandatory in case of a single bench resting on the wall. Recommended in case of side-by-side benches resting on the wall.
Obbligatorio in caso di panca singola che poggia a parete. Consigliato in caso di panche affiancate che poggiano a parete.

The benches are suitable for wall mounting, if not we recommend to order the backside panel, see at page 186
Le panche sono adatte per utilizzo a parete. Diversamente consigliamo l'acquisto del pannello posteriore, si veda da pag. 186

For fabrics see page 325
Per i tessuti si veda a p. 325

Dimensions of Modus units are expressed in centimeters
Le misure dei moduli Modus sono espresse in centimetri

Modus

Back to back unit
Bifacciale

MDB_110



MDWB_110



MDB_110

MDB_110_L100

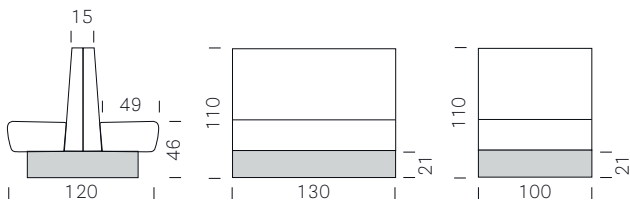

MDWB_110

MDWB_110_L100

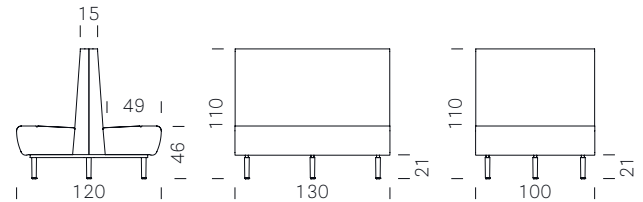

ART. MD4

Baseboard finishes available / Zoccolo disponibile nei colori



Ash wood legs / Gambe in frassino



FABRIC Tessuto	SMOOTH Liscio	BUTTONS Bottoni	CAPITONÉ Capitoné	HORIZONTAL STITCHES Cuciture orizzontali	VERTICAL STITCHES Cuciture verticali
C*	€ 2.707,00	€ 2.798,00	€ 3.222,00	€ 2.876,00	€ 2.993,00
D40+D44	€ 2.894,00	€ 2.985,00	€ 3.409,00	€ 3.063,00	€ 3.180,00
E	€ 3.282,00	€ 3.373,00	€ 3.796,00	€ 3.451,00	€ 3.568,00
G	€ 3.282,00	€ 3.373,00	€ 3.796,00	€ 3.451,00	€ 3.568,00
H*	€ 2.801,00	€ 2.892,00	€ 3.315,00	€ 2.970,00	€ 3.087,00
N	€ 3.484,00	€ 3.575,00	€ 3.999,00	€ 3.653,00	€ 3.770,00

*Excluding / Escluso C36+C39, C83+C89; C100+C101, C110+C122, H140+H143

Surcharge COUPLE SIDEBBOARD L = 85,5 cm (item MD4/LAT_100) = € 208,00
 Supplemento COPPIA ZOCCOLO LATERALE L = 85,5 cm (cod. MD4/LAT_100) = € 208,00

For fabrics see page 325
 Per i tessuti si veda a p. 325

Dimensions of Modus units are expressed in centimeters
 Le misure dei moduli Modus sono espresse in centimetri

Modus

Back to back unit
Bifacciale

MDB_140



MDWB_140

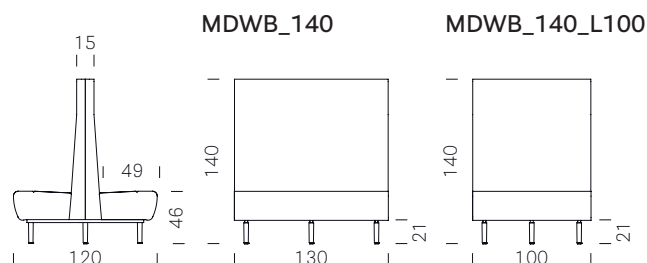
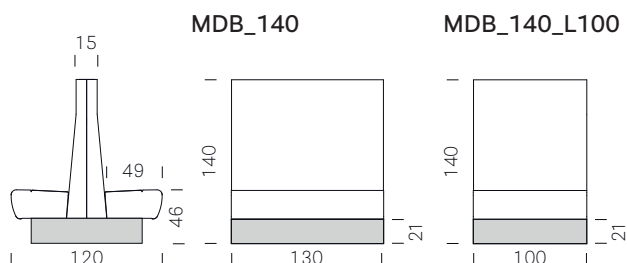

ART. MD4

Baseboard finishes available / Zoccolo disponibile nei colori



Ash wood legs / Gambe in frassino



FABRIC Tessuto	SMOOTH Liscio	BUTTONS Bottoni	CAPITONÉ Capitoné	HORIZONTAL STITCHES Cuciture orizzontali	VERTICAL STITCHES Cuciture verticali
C*	€ 3.126,00	€ 3.295,00	€ 4.041,00	€ 3.451,00	€ 3.451,00
D40+D44	€ 3.370,00	€ 3.539,00	€ 4.285,00	€ 3.695,00	€ 3.695,00
E	€ 3.682,00	€ 3.851,00	€ 4.597,00	€ 4.007,00	€ 4.007,00
G	€ 3.682,00	€ 3.851,00	€ 4.597,00	€ 4.007,00	€ 4.007,00
H*	€ 3.245,00	€ 3.414,00	€ 4.160,00	€ 3.570,00	€ 3.570,00
N	€ 3.932,00	€ 4.101,00	€ 4.847,00	€ 4.257,00	€ 4.257,00

*Excluding / Escluso C36+C39, C83+C89; C100+C101, C110+C122, H140+H143

Surcharge COUPLE SIDEBOARD L = 85,5 cm (item MD4/LAT_100) = € 208,00
 Supplemento COPPIA ZOCCOLO LATERALE L = 85,5 cm (cod. MD4/LAT_100) = € 208,00

For fabrics see page 325
 Per i tessuti si veda a p. 325

Dimensions of Modus units are expressed in centimeters
 Le misure dei moduli Modus sono espresse in centimetri

Modus

Back to back unit
Bifacciale

MDB_175

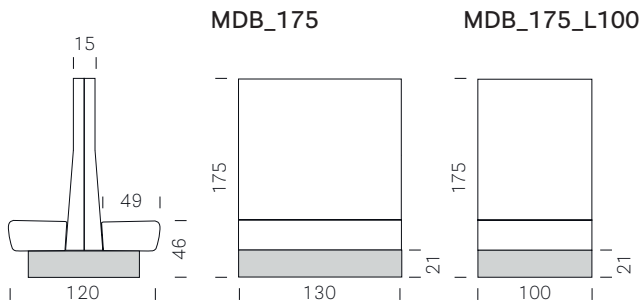

ART. MD4

Baseboard finishes available / Zoccolo disponibile nei colori



AS NE OA2

FABRIC Tessuto	SMOOTH Liscio	BUTTONS Bottoni	CAPITONÉ Capitoné	HORIZONTAL STITCHES Cuciture orizzontali
C*	€ 3.126,00	€ 3.295,00	€ 4.041,00	€ 3.451,00
D40+D44	€ 3.370,00	€ 3.539,00	€ 4.285,00	€ 3.695,00
E	€ 3.682,00	€ 3.851,00	€ 4.597,00	€ 4.007,00
G	€ 3.682,00	€ 3.851,00	€ 4.597,00	€ 4.007,00
H*	€ 3.245,00	€ 3.414,00	€ 4.160,00	€ 3.570,00
N	€ 3.932,00	€ 4.101,00	€ 4.847,00	€ 4.257,00

*Excluding / Escluso C36+C39, C83+C89; C100+C101, C110+C122, H140+H143

Surcharge COUPLE SIDEBOARD L = 85,5 cm (item MD4/LAT_100) = € 208,00
Supplemento COPPIA ZOCCOLO LATERALE L = 85,5 cm (cod. MD4/LAT_100) = € 208,00

For fabrics see page 325
Per i tessuti si veda a p. 325

Dimensions of Modus units are expressed in centimeters
Le misure dei moduli Modus sono espresse in centimetri

Modus

Corner unit
Angolare

MDA_110



MDA_140

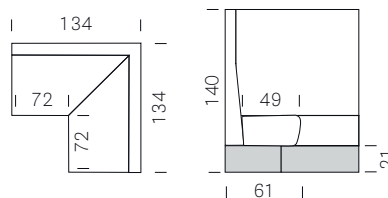
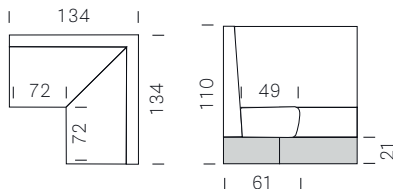

ART. MD4

Baseboard finishes available / Zoccolo disponibile nei colori



AS NE OA2

FABRIC Tessuto	SMOOTH Liscio	BUTTONS Bottoni	CAPITONÉ Capitoné	HORIZONTAL STITCHES Cuciture orizzontali	VERTICAL STITCHES Cuciture verticali
C*	€ 2.772,00	€ 2.863,00	€ 3.287,00	€ 2.941,00	€ 3.058,00
D40+D44	€ 2.959,00	€ 3.050,00	€ 3.474,00	€ 3.128,00	€ 3.245,00
E	€ 3.347,00	€ 3.438,00	€ 3.861,00	€ 3.516,00	€ 3.633,00
G	€ 3.347,00	€ 3.438,00	€ 3.861,00	€ 3.516,00	€ 3.633,00
H*	€ 2.866,00	€ 2.957,00	€ 3.380,00	€ 3.035,00	€ 3.152,00
N	€ 3.549,00	€ 3.640,00	€ 4.064,00	€ 3.718,00	€ 3.835,00

*Excluding / Escluso C36+C39, C83+C89; C100+C101, C110+C122, H140+H143

Surcharge COUPLE SIDEBORD L = 44 cm (item MD4/LAT_50) = € 117,00
Supplemento COPPIA ZOCCOLO LATERALE L = 44 cm (cod. MD4/LAT_50) = € 117,00

FABRIC Tessuto	SMOOTH Liscio	BUTTONS Bottoni	CAPITONÉ Capitoné	HORIZONTAL STITCHES Cuciture orizzontali	VERTICAL STITCHES Cuciture verticali
C*	€ 3.204,00	€ 3.373,00	€ 4.119,00	€ 3.529,00	€ 3.529,00
D40+D44	€ 3.448,00	€ 3.617,00	€ 4.363,00	€ 3.773,00	€ 3.773,00
E	€ 3.760,00	€ 3.929,00	€ 4.675,00	€ 4.085,00	€ 4.085,00
G	€ 3.760,00	€ 3.929,00	€ 4.675,00	€ 4.085,00	€ 4.085,00
H*	€ 3.323,00	€ 3.492,00	€ 4.238,00	€ 3.648,00	€ 3.648,00
N	€ 4.010,00	€ 4.179,00	€ 4.925,00	€ 4.335,00	€ 4.335,00

*Excluding / Escluso C36+C39, C83+C89; C100+C101, C110+C122, H140+H143

The benches are suitable for wall mounting, if not we recommend to order the backside panel, see at page 186
Le panche sono adatte per utilizzo a parete. Diversamente consigliamo l'acquisto del pannello posteriore, si veda da pag. 186

For fabrics see page 325
Per i tessuti si veda a p. 325

Dimensions of Modus units are expressed in centimeters
Le misure dei moduli Modus sono espresse in centimetri

Modus

Corner unit
Angolare

MDA_175

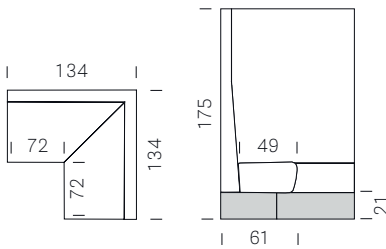

MDA_240

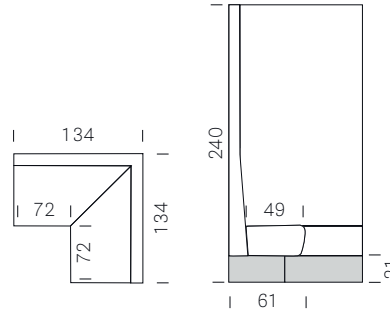
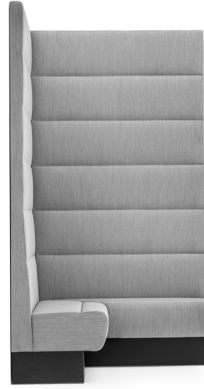

ART. MD4

Baseboard finishes available / Zoccolo disponibile nei colori



FABRIC Tessuto	SMOOTH Liscio	BUTTONS Bottoni	CAPITONÉ Capitoné	HORIZONTAL STITCHES Cuciture orizzontali
C*	€ 3.204,00	€ 3.373,00	€ 4.119,00	€ 3.529,00
D40+D44	€ 3.448,00	€ 3.617,00	€ 4.363,00	€ 3.773,00
E	€ 3.760,00	€ 3.929,00	€ 4.675,00	€ 4.085,00
G	€ 3.760,00	€ 3.929,00	€ 4.675,00	€ 4.085,00
H*	€ 3.323,00	€ 3.492,00	€ 4.238,00	€ 3.648,00
N	€ 4.010,00	€ 4.179,00	€ 4.925,00	€ 4.335,00

*Excluding / Escluso C36+C39, C83+C89; C100+C101, C110+C122, H140+H143

Surcharge COUPLE SIDEBORD L = 44 cm (item MD4/LAT_50) = € 117,00
 Supplemento COPPIA ZOCCOLO LATERALE L = 44 cm (cod. MD4/LAT_50) = € 117,00

FABRIC Tessuto	SMOOTH Liscio	BUTTONS Bottoni	HORIZONTAL STITCHES Cuciture orizzontali
C*	€ 3.851,00	€ 4.051,00	€ 4.267,00
D40+D44	€ 4.192,00	€ 4.392,00	€ 4.608,00
E	€ 4.639,00	€ 4.839,00	€ 5.055,00
G	€ 4.639,00	€ 4.839,00	€ 5.055,00
H*	€ 4.049,00	€ 4.249,00	€ 4.465,00
N	€ 4.933,00	€ 5.133,00	€ 5.349,00

*Excluding / Escluso C36+C39, C83+C89; C100+C101, C110+C122, H140+H143

The benches are suitable for wall mounting, if not we recommend to order the backside panel, see at page 186
 Le panche sono adatte per utilizzo a parete. Diversamente consigliamo l'acquisto del pannello posteriore, si veda da pag. 186

For fabrics see page 325
 Per i tessuti si veda a p. 325

Dimensions of Modus units are expressed in centimeters
 Le misure dei moduli Modus sono espresse in centimetri

Modus

Back to back corner unit
Angolare bifacciale

MDAB_110



MDAB_140

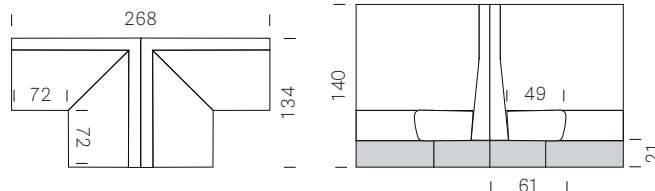
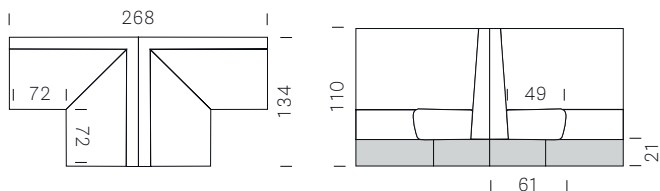

ART. MD4

Baseboard finishes available / Zoccolo disponibile nei colori



FABRIC Tessuto	SMOOTH Liscio	BUTTONS Bottoni	CAPITONÉ Capitoné	HORIZONTAL STITCHES Cuciture orizzontali	VERTICAL STITCHES Cuciture verticali
C*	€ 5.544,00	€ 5.726,00	€ 6.573,00	€ 5.882,00	€ 6.116,00
D40+D44	€ 5.918,00	€ 6.100,00	€ 6.948,00	€ 6.256,00	€ 6.490,00
E	€ 6.693,00	€ 6.875,00	€ 7.722,00	€ 7.031,00	€ 7.265,00
G	€ 6.693,00	€ 6.875,00	€ 7.722,00	€ 7.031,00	€ 7.265,00
H*	€ 5.731,00	€ 5.913,00	€ 6.760,00	€ 6.069,00	€ 6.303,00
N	€ 7.098,00	€ 7.280,00	€ 8.128,00	€ 7.436,00	€ 7.670,00

*Excluding / Escluso C36+C39, C83+C89; C100+C101, C110+C122, H140+H143

Surcharge COUPLE SIDEBORD L = 85,5 cm (item MD4/LAT_100) = € 208,00
Supplemento COPPIA ZOCCOLO LATERALE L = 85,5 cm (cod. MD4/LAT_100) = € 208,00

FABRIC Tessuto	SMOOTH Liscio	BUTTONS Bottoni	CAPITONÉ Capitoné	HORIZONTAL STITCHES Cuciture orizzontali	VERTICAL STITCHES Cuciture verticali
C*	€ 6.407,00	€ 6.745,00	€ 8.237,00	€ 7.057,00	€ 7.057,00
D40+D44	€ 6.896,00	€ 7.234,00	€ 8.726,00	€ 7.546,00	€ 7.546,00
E	€ 7.520,00	€ 7.858,00	€ 9.350,00	€ 8.170,00	€ 8.170,00
G	€ 7.520,00	€ 7.858,00	€ 9.350,00	€ 8.170,00	€ 8.170,00
H*	€ 6.646,00	€ 6.984,00	€ 8.476,00	€ 7.296,00	€ 7.296,00
N	€ 8.019,00	€ 8.357,00	€ 9.849,00	€ 8.669,00	€ 8.669,00

*Excluding / Escluso C36+C39, C83+C89; C100+C101, C110+C122, H140+H143

The benches are suitable for wall mounting, if not we recommend to order the backside panel, see at page 186
Le panche sono adatte per utilizzo a parete. Diversamente consigliamo l'acquisto del pannello posteriore, si veda da pag. 186

For fabrics see page 325
Per i tessuti si veda a p. 325

Dimensions of Modus units are expressed in centimeters
Le misure dei moduli Modus sono espresse in centimetri

Modus

Back to back corner unit
Angolare bifacciale

MDAB_175

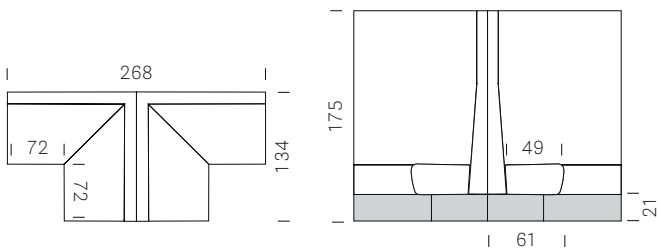

ART. MD4

Baseboard finishes available / Zoccolo disponibile nei colori



AS NE OA2

FABRIC Tessuto	SMOOTH Liscio	BUTTONS Bottoni	CAPITONÉ Capitoné	HORIZONTAL STITCHES Cuciture orizzontali
C*	€ 6.407,00	€ 6.745,00	€ 8.237,00	€ 7.057,00
D40+D44	€ 6.896,00	€ 7.234,00	€ 8.726,00	€ 7.546,00
E	€ 7.520,00	€ 7.858,00	€ 9.350,00	€ 8.170,00
G	€ 7.520,00	€ 7.858,00	€ 9.350,00	€ 8.170,00
H*	€ 6.646,00	€ 6.984,00	€ 8.476,00	€ 7.296,00
N	€ 8.019,00	€ 8.357,00	€ 9.849,00	€ 8.669,00

*Excluding / Escluso C36+C39, C83+C89; C100+C101, C110+C122, H140+H143

Surcharge COUPLE SIDEBORD L = 85,5 cm (item MD4/LAT_100) = € 208,00
Supplemento COPPIA ZOCCOLO LATERALE L = 85,5 cm (cod. MD4/LAT_100) = € 208,00

The benches are suitable for wall mounting, if not we recommend to order the backside panel, see at page 186
Le panche sono adatte per utilizzo a parete. Diversamente consigliamo l'acquisto del pannello posteriore, si veda da pag. 186

For fabrics see page 325
Per i tessuti si veda a p. 325

Dimensions of Modus units are expressed in centimeters
Le misure dei moduli Modus sono espresse in centimetri

Modus

Customized linear unit - Available for items MDL_110, MDL_140
Lineare personalizzato - Disponibile per art. MDL_110, MDL_140

MDP_110 **

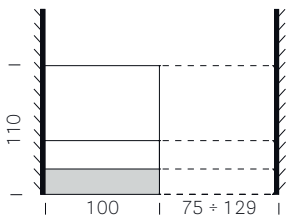
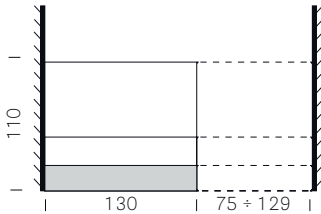

MDP_140 **

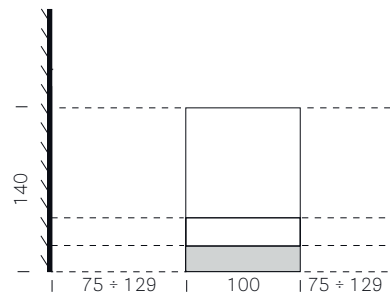
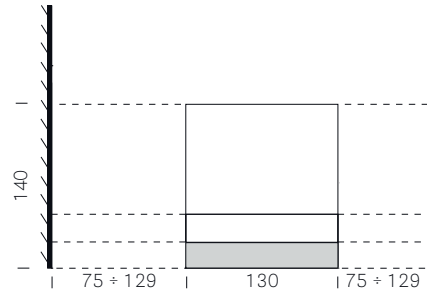

ART. MD4

Baseboard finishes available / Zoccolo disponibile nei colori



AS NE OA2

FABRIC Tessuto	SMOOTH Liscio	HORIZONTAL STITCHES Cuciture orizzontali
C*	€ 1.664,00	€ 1.766,00
D40+D44	€ 1.776,00	€ 1.878,00
E	€ 2.009,00	€ 2.110,00
G	€ 2.009,00	€ 2.110,00
H*	€ 1.720,00	€ 1.822,00
N	€ 2.130,00	€ 2.231,00

*Excluding / Escluso C36+C39, C83+C89; C100+C101, C110+C122, H140+H143

Surcharge COUPLE SIDEBBOARD L = 44 cm (item MD4/LAT_50) = € 117,00
Supplemento COPPIA ZOCCOLO LATERALE L = 44 cm (cod. MD4/LAT_50) = € 117,00

**KIT/MD2_FIX_MURO = € 26,00

Mandatory in case of a single bench resting on the wall. Recommended in case of side-by-side benches resting on the wall.
Obbligatorio in caso di panca singola che poggia a parete. Consigliato in caso di panche affiancate che poggiano a parete.

For fabrics see page 325
Per i tessuti si veda a p. 325

Dimensions of Modus units are expressed in centimeters
Le misure dei moduli Modus sono espresse in centimetri

FABRIC Tessuto	SMOOTH Liscio	HORIZONTAL STITCHES Cuciture orizzontali
C*	€ 1.923,00	€ 2.118,00
D40+D44	€ 2.070,00	€ 2.265,00
E	€ 2.257,00	€ 2.452,00
G	€ 2.257,00	€ 2.452,00
H*	€ 1.995,00	€ 2.190,00
N	€ 2.407,00	€ 2.602,00

*Excluding / Escluso C36+C39, C83+C89; C100+C101, C110+C122, H140+H143

Modus

Customized linear unit - Available for items MDL_175, MDL_240
Lineare personalizzato - Disponibile per art. MDL_175, MDL_240

MDP_175 **

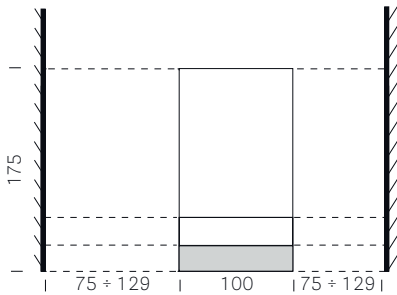
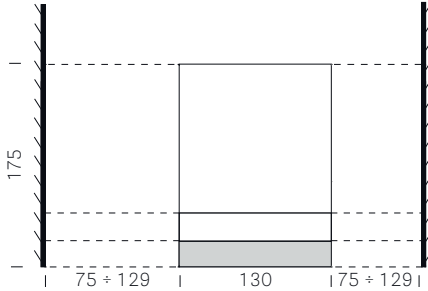

MDP_240

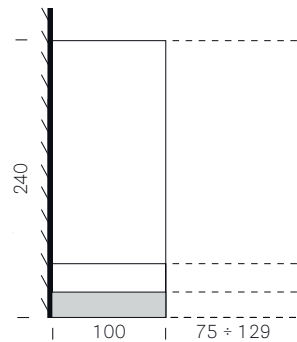
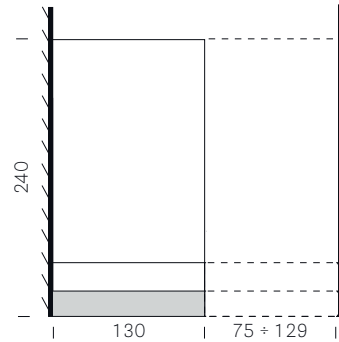

ART. MD4

Baseboard finishes available / Zoccolo disponibile nei colori

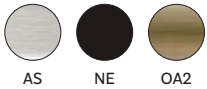

FABRIC Tessuto	SMOOTH Liscio	HORIZONTAL STITCHES Cuciture orizzontali
C*	€ 1.923,00	€ 2.118,00
D40÷D44	€ 2.070,00	€ 2.265,00
E	€ 2.257,00	€ 2.452,00
G	€ 2.257,00	€ 2.452,00
H*	€ 1.995,00	€ 2.190,00
N	€ 2.407,00	€ 2.602,00

*Excluding / Escluso C36÷C39, C83÷C89; C100÷C101, C110÷C122, H140÷H143

Surcharge COUPLE SIDEBBOARD L = 44 cm (item MD4/LAT_50) = € 117,00
Supplemento COPPIA ZOCCOLO LATERALE L = 44 cm (cod. MD4/LAT_50) = € 117,00

**KIT/MD2_FIX_MURO = € 26,00

Mandatory in case of a single bench resting on the wall. Recommended in case of side-by-side benches resting on the wall.
Obbligatorio in caso di panca singola che poggia a parete. Consigliato in caso di panche affiancate che poggiano a parete.

For fabrics see page 325
Per i tessuti si veda a p. 325

Dimensions of Modus units are expressed in centimeters
Le misure dei moduli Modus sono espresse in centimetri

FABRIC Tessuto	SMOOTH Liscio	HORIZONTAL STITCHES Cuciture orizzontali
C*	€ 2.312,00	€ 2.561,00
D40÷D44	€ 2.516,00	€ 2.766,00
E	€ 2.784,00	€ 3.033,00
G	€ 2.784,00	€ 3.033,00
H*	€ 2.430,00	€ 2.680,00
N	€ 2.961,00	€ 3.210,00

*Excluding / Escluso C36÷C39, C83÷C89; C100÷C101, C110÷C122, H140÷H143

Modus

Backside laminate panel - Available for items MDL_110, MDL_140, MDL_175
 Pannello posteriore in laminato - Disponibile per art. MDL_110, MDL_140, MDL_175

For Modus linear 130 cm
 Per Modus lineare 130 cm

MD5_110x130

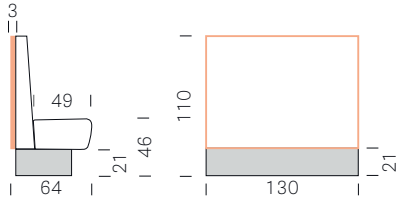

MD5_140x130

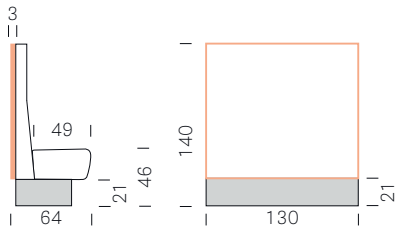

MD5_175x130

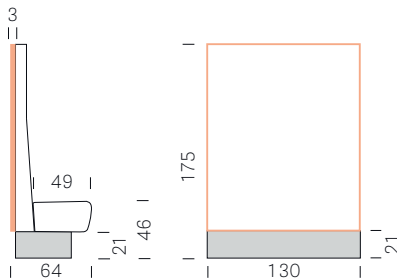

PANEL Pannello	HEIGHT Altezza	WIDTH Larghezza	PRICE * Prezzo
MD5_110x130	110	130	€ 415,00
MD5_140x130	140	130	€ 611,00
MD5_175x130	175	130	€ 611,00

* Packing and back kickboard included
 Imballo e zoccolo posteriore inclusi

ART. MD5

Laminate back side panel with ABS edge, thickness 30 mm, colours available
 Pannello in laminato con bordo ABS, spessore 30 mm, disponibile nei colori

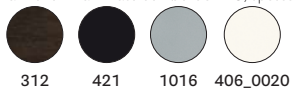

Dimensions of Modus units are expressed in centimeters
 Le misure dei moduli Modus sono espresse in centimetri

For Modus linear 100 cm
 Per Modus lineare 100 cm

MD5_110x100

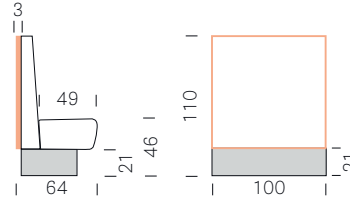

MD5_140x100

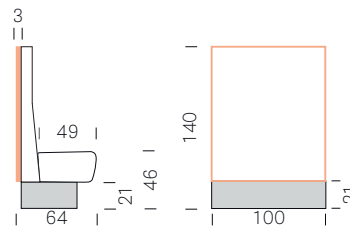

MD5_175x100

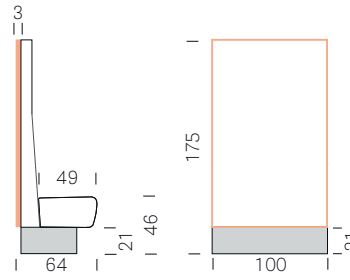

PANEL Pannello	HEIGHT Altezza	WIDTH Larghezza	PRICE * Prezzo
MD5_110x100	110	100	€ 415,00
MD5_140x100	140	100	€ 611,00
MD5_175x100	175	100	€ 611,00

Modus

Backside laminate panel - Available for items MDA_110, MDA_140, MDA_175
 Pannello posteriore in laminato - Disponibile per art. MDA_110, MDA_140, MDA_175

For Modus corner unit
 Per Modus angolare

MD5_110x134

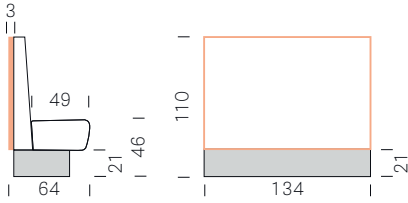

MD5_140x134

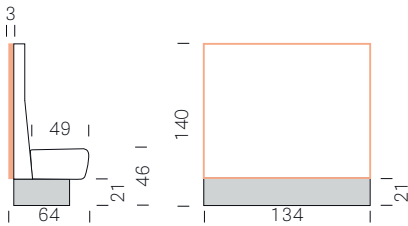

MD5_175x134

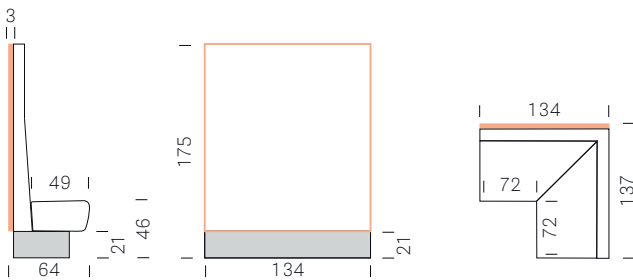

PANEL Pannello	HEIGHT Altezza	WIDTH Larghezza	PRICE * Prezzo
MD5_110x134	110	134	€ 415,00
MD5_140x134	140	134	€ 611,00
MD5_175x134	175	134	€ 611,00

* Packing and back kickboard included
 Imballo e zoccolo posteriore inclusi

ART. MD5

Laminate back side panel with ABS edge, thickness 30 mm, colours available
 Pannello in laminato con bordo ABS, spessore 30 mm, disponibile nei colori

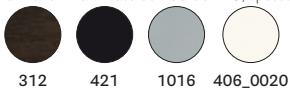

Dimensions of Modus units are expressed in centimeters
 Le misure dei moduli Modus sono espresse in centimetri

Modus

Backside upholstered panel - Available for items MDL_175, MDA_175
 Pannello posteriore imbottito - Disponibile per art. MDL_175, MDA_175

For Modus linear 130 cm
 Per Modus lineare 130 cm

MD5_175x130

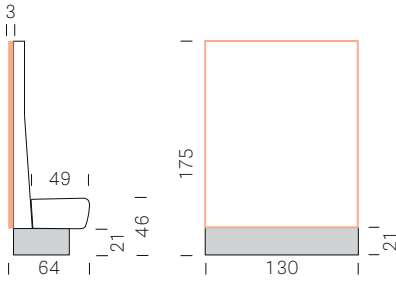

For Modus linear 100 cm
 Per Modus lineare 100 cm

MD5_175x100

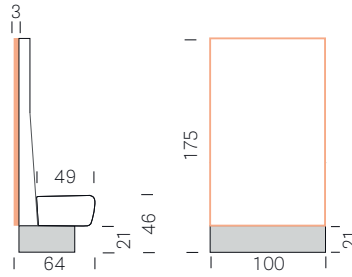

For Modus corner unit
 Per Modus angolare

MD5_175x134

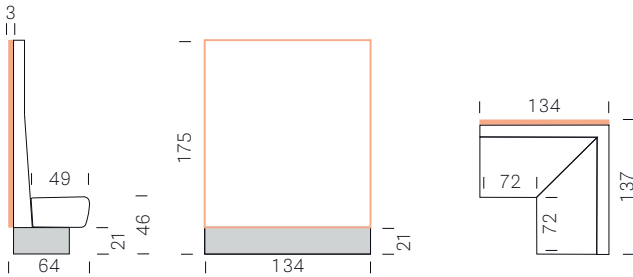

PANEL Pannello	HEIGHT Altezza	WIDTH Larghezza	FABRIC Tessuto	PRICE ** Prezzo
MD5_175x130	175	130	C*	€ 865,00
MD5_175x134	175	134	D40+D44	€ 951,00
			E	€ 1.196,00
			G	€ 1.196,00
			H*	€ 897,00
			N	€ 1.248,00

*Excluding / Escluso C36+C39, C83+C89; C100+C101, C110+C122, H140+H143

**Packing and back kickboard included
 Imballo e zoccolo posteriore inclusi

PANEL Pannello	HEIGHT Altezza	WIDTH Larghezza	FABRIC Tessuto	PRICE ** Prezzo
MD5_175x100	175	100	C*	€ 741,00
			D40+D44	€ 782,00
			E	€ 904,00
			G	€ 904,00
			H*	€ 754,00
			N	€ 930,00

*Excluding / Escluso C36+C39, C83+C89; C100+C101, C110+C122, H140+H143

**Packing and back kickboard included
 Imballo e zoccolo posteriore inclusi

For fabrics see page 325
 Per i tessuti si veda a p. 325

Dimensions of Modus units are expressed in centimeters
 Le misure dei moduli Modus sono espresse in centimetri

Modus 2.0

Linear
Lineare

MD/2L_110



MD/2WL_110



MD/2L_110

MD/2L_110_L100

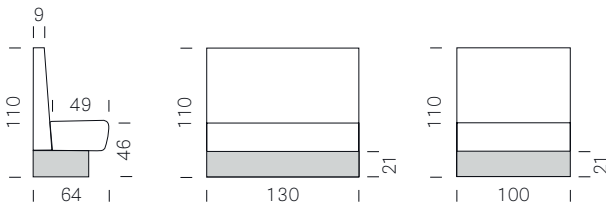

MD/2WL_110

MD/2WL_110_L100

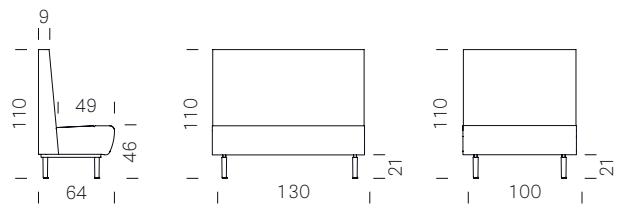

ART. MD4

Baseboard finishes available / Zoccolo disponibile nei colori

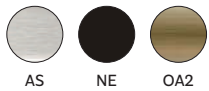

Ash wood legs / Gambe in frassino



FABRIC Tessuto	SMOOTH Liscio	HORIZONTAL STITCHES Cuciture orizzontali	VERTICAL STITCHES Cuciture verticali
C*	€ 2.040,00	€ 2.083,00	€ 2.142,00
D40+D44	€ 2.261,00	€ 2.304,00	€ 2.363,00
E	€ 2.597,00	€ 2.639,00	€ 2.698,00
G	€ 2.597,00	€ 2.639,00	€ 2.698,00
H*	€ 2.118,00	€ 2.161,00	€ 2.220,00
N	€ 2.759,00	€ 2.802,00	€ 2.860,00

*Excluding / Escluso C36+C39, C83+C89; C100+C101, C110+C122, H140+H143

Surcharge COUPLE SIDEBORD L = 44 cm (item MD4/LAT_50) = € 117,00
 Supplemento COPPIA ZOCCOLO LATERALE L = 44 cm (cod. MD4/LAT_50) = € 117,00

For fabrics see page 325
 Per i tessuti si veda a p. 325

Dimensions of Modus units are expressed in centimeters
 Le misure dei moduli Modus sono espresse in centimetri

Modus 2.0

Linear
Lineare

MD/2L_140



MD/2WL_140

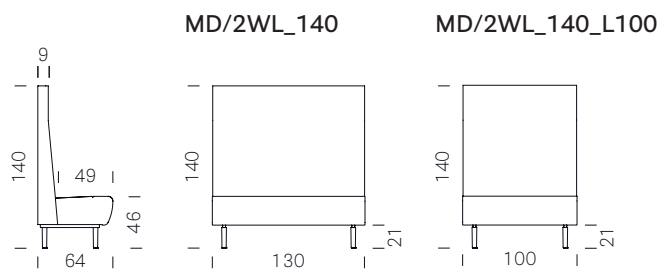
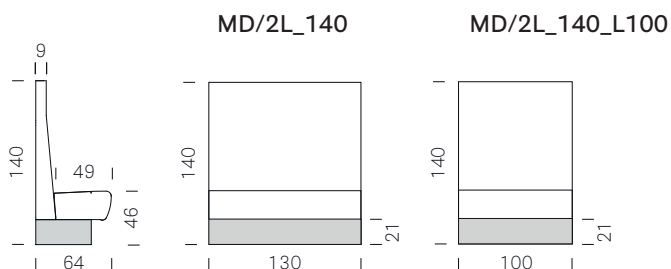

ART. MD4

Baseboard finishes available / Zoccolo disponibile nei colori



Ash wood legs / Gambe in frassino



FABRIC Tessuto	SMOOTH Liscio	HORIZONTAL STITCHES Cuciture orizzontali	VERTICAL STITCHES Cuciture verticali
C*	€ 2.040,00	€ 2.083,00	€ 2.142,00
D40+D44	€ 2.261,00	€ 2.304,00	€ 2.363,00
E	€ 2.597,00	€ 2.639,00	€ 2.698,00
G	€ 2.597,00	€ 2.639,00	€ 2.698,00
H*	€ 2.118,00	€ 2.161,00	€ 2.220,00
N	€ 2.759,00	€ 2.802,00	€ 2.860,00

*Excluding / Escluso C36+C39, C83+C89; C100+C101, C110+C122, H140+H143

Surcharge COUPLE SIDEBORD L = 44 cm (item MD4/LAT_50) = € 117,00
 Supplemento COPPIA ZOCCOLO LATERALE L = 44 cm (cod. MD4/LAT_50) = € 117,00

For fabrics see page 325
 Per i tessuti si veda a p. 325

Dimensions of Modus units are expressed in centimeters
 Le misure dei moduli Modus sono espresse in centimetri

Modus 2.0

Corner unit
Angolare

MD/2A_110



MD/2A_140

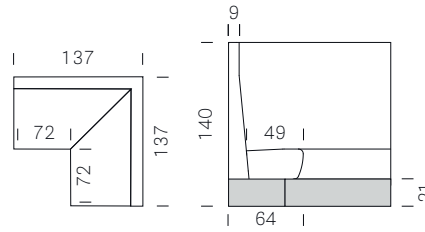
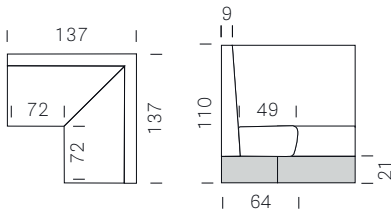

ART. MD4

Baseboard finishes available / Zoccolo disponibile nei colori

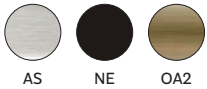

FABRIC Tessuto	SMOOTH Liscio	HORIZONTAL STITCHES Cuciture orizzontali	VERTICAL STITCHES Cuciture verticali
C*	€ 4.223,00	€ 4.309,00	€ 4.426,00
D40+D44	€ 4.665,00	€ 4.751,00	€ 4.868,00
E	€ 5.336,00	€ 5.421,00	€ 5.538,00
G	€ 5.336,00	€ 5.421,00	€ 5.538,00
H*	€ 4.379,00	€ 4.465,00	€ 4.582,00
N	€ 5.661,00	€ 5.746,00	€ 5.863,00

*Excluding / Escluso C36+C39, C83+C89; C100+C101, C110+C122, H140+H143

Surcharge COUPLE SIDEBORD L = 44 cm (item MD4/LAT_50) = € 117,00
 Supplemento COPPIA ZOCCOLO LATERALE L = 44 cm (cod. MD4/LAT_50) = € 117,00

For fabrics see page 325
 Per i tessuti si veda a p. 325

Dimensions of Modus units are expressed in centimeters
 Le misure dei moduli Modus sono espresse in centimetri

Modus 2.0

Back shelf - Available for items MD/2L_140, MD/2A_140
 Mensola posteriore - Disponibile per art. MD/2L_140, MD/2A_140

For Modus 2.0 linear L130, H140 cm
 Per Modus 2.0 lineare L130, H140 cm

K_MD/2L_M_finitura_L130

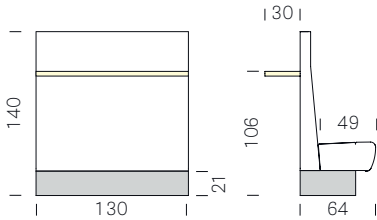

Shelf 130x30 cm, thickness 4 cm,
 LAMINATE or FENIX, ABS edge in matching colour: **€ 258,00**

Mensola 130x30 cm, spessore 4 cm,
 LAMINATO o FENIX, bordo ABS in tinta: **€ 258,00**

For Modus 2.0 linear L100, H140 cm
 Per Modus 2.0 lineare L100, H140 cm

K_MD/2L_M_finitura_L100

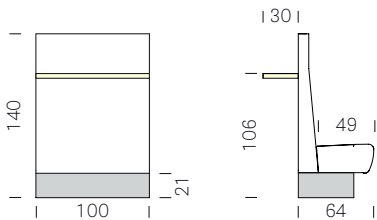

Shelf 100x30 cm, thickness 4 cm,
 LAMINATE or FENIX, ABS edge in matching colour: **€ 258,00**

Mensola 100x30 cm, spessore 4 cm,
 LAMINATO o FENIX, bordo ABS in tinta: **€ 258,00**

Laminate colours / Colori laminato

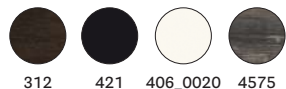

FENIX colours / Colori FENIX

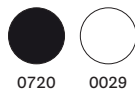

Dimensions of Modus units are expressed in centimeters
 Le misure dei moduli Modus sono espresse in centimetri

For Modus 2.0 corner unit, H140 cm
 Per Modus 2.0 angolare, H140 cm

K_MD/2A_M_finitura_L137

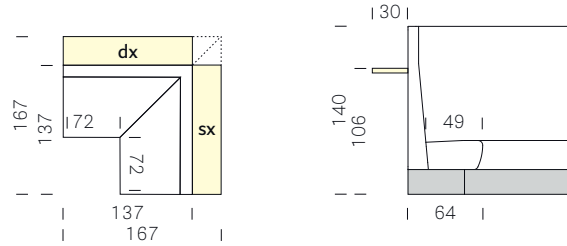

Single shelf for corner unit bench 137x30 cm, thickness 4 cm,
 LAMINATE or FENIX, ABS edge matching colour: **€ 284,00 (single shelf)**
 Mention the correct shelf needed: left, right or both

Mensola singola per panca angolare, 137x30 cm, spessore 4 cm,
 LAMINATO o FENIX, bordo ABS in tinta: **€ 284,00 (mensola singola)**
 Specificare se si necessita di mensola destra, sinistra o entrambe

K_MD/2A_M_finitura

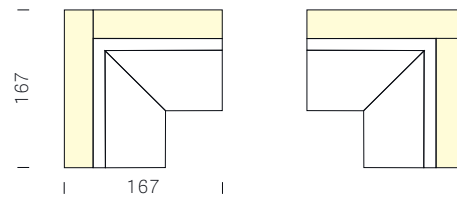

Shelf 167x167x30 cm, thickness 4 cm,
 LAMINATE or FENIX, ABS edge in matching colour: **€ 709,00**

Mensola angolare 167x167x30 cm, spessore 4 cm,
 LAMINATO o FENIX, bordo ABS in tinta: **€ 709,00**

Modus 2.0



Single curved unit 60°
Curva singola 60°
MD/2C60_140

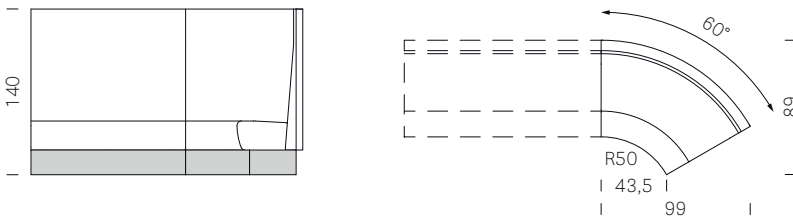

The single curved unit is not free standing. It must be combined with another linear or curved unit Modus 2.0
La curva singola non è autoportante. Va abbinata a un modulo lineare o a una curva Modus 2.0

FABRIC Tessuto	SMOOTH Liscio	HORIZONTAL STITCHES Cuciture orizzontali	VERTICAL STITCHES Cuciture verticali
C *	€ 2.482,00	€ 2.525,00	€ 2.525,00
D40÷D44	€ 2.760,00	€ 2.803,00	€ 2.803,00
E	€ 3.189,00	€ 3.232,00	€ 3.232,00
G	€ 3.189,00	€ 3.232,00	€ 3.232,00
H *	€ 2.580,00	€ 2.623,00	€ 2.623,00
N	€ 3.907,00	€ 3.950,00	€ 3.950,00

*Excluding / Escluso C36÷C39, C83÷C89; C100÷C101, C110÷C122, H140÷H143

Double curved unit 60°
Doppia curva singola 60°
MD/2C60_140 (2 pcs/pz)

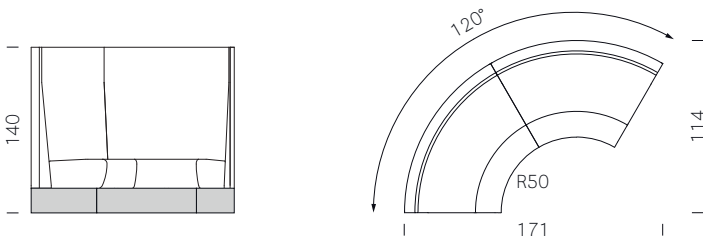

FABRIC Tessuto	SMOOTH Liscio	HORIZONTAL STITCHES Cuciture orizzontali	VERTICAL STITCHES Cuciture verticali
C *	€ 4.963,00	€ 5.048,00	€ 5.048,00
D40÷D44	€ 5.520,00	€ 5.606,00	€ 5.606,00
E	€ 6.378,00	€ 6.464,00	€ 6.464,00
G	€ 6.378,00	€ 6.464,00	€ 6.464,00
H *	€ 5.158,00	€ 5.243,00	€ 5.243,00
N	€ 6.783,00	€ 6.868,00	€ 6.868,00

*Excluding / Escluso C36÷C39, C83÷C89; C100÷C101, C110÷C122, H140÷H143

ART. MD4

Baseboard finishes available / Zoccolo disponibile nei colori



Surcharge COUPLE SIDEBBOARD L = 44 cm (item MD4/LAT_50) = € 117,00
Supplemento COPPIA ZOCCOLO LATERALE L = 44 cm (cod. MD4/LAT_50) = € 117,00

For fabrics see page 325
Per i tessuti si veda a p. 325

Dimensions of Modus units are expressed in centimeters
Le misure dei moduli Modus sono espresse in centimetri

Modus 2.0

Triple curved unit 60°
Tripla curva singola 60°

MD/2C60_140 (3 pcs/pz)

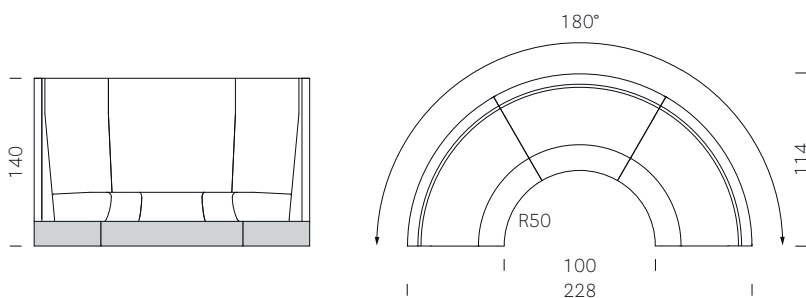

FABRIC Tessuto	SMOOTH Liscio	HORIZONTAL STITCHES Cuciture orizzontali	VERTICAL STITCHES Cuciture verticali
C *	€ 7.444,00	€ 7.573,00	€ 7.573,00
D40÷D44	€ 8.280,00	€ 8.409,00	€ 8.409,00
E	€ 9.567,00	€ 9.696,00	€ 9.696,00
G	€ 9.567,00	€ 9.696,00	€ 9.696,00
H *	€ 7.735,00	€ 7.864,00	€ 7.864,00
N	€ 10.173,00	€ 10.302,00	€ 10.302,00

*Excluding / Escluso C36+C39, C83+C89; C100+C101, C110+C122, H140+H143

Quadruple curved unit 60°
Quadrupla curva singola 60°

MD/2C60_140 (4 pcs/pz)

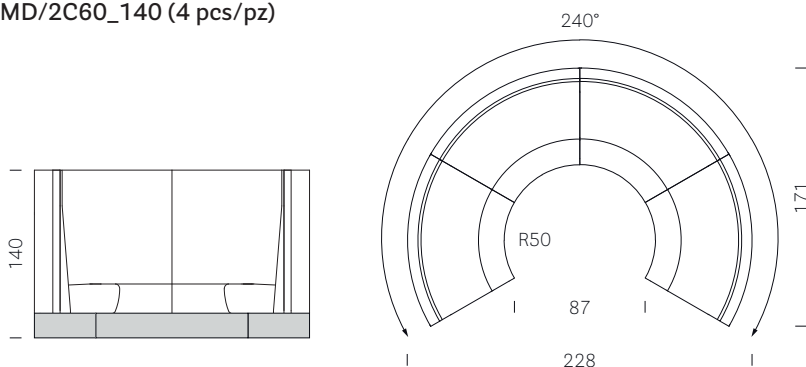

FABRIC Tessuto	SMOOTH Liscio	HORIZONTAL STITCHES Cuciture orizzontali	VERTICAL STITCHES Cuciture verticali
C *	€ 9.925,00	€ 10.096,00	€ 10.096,00
D40÷D44	€ 11.040,00	€ 11.212,00	€ 11.212,00
E	€ 12.756,00	€ 12.928,00	€ 12.928,00
G	€ 12.756,00	€ 12.928,00	€ 12.928,00
H *	€ 10.315,00	€ 10.486,00	€ 10.486,00
N	€ 13.563,00	€ 13.735,00	€ 13.735,00

*Excluding / Escluso C36+C39, C83+C89; C100+C101, C110+C122, H140+H143

ART. MD4

Baseboard finishes available / Zoccolo disponibile nei colori

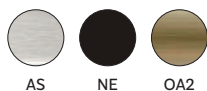

AS NE OA2

Surcharge COUPLE SIDEBBOARD L = 44 cm (item MD4/LAT_50) = € 117,00

Supplemento COPPIA ZOCCOLO LATERALE L = 44 cm (cod. MD4/LAT_50) = € 117,00

For fabrics see page 325
Per i tessuti si veda a p. 325

Dimensions of Modus units are expressed in centimeters
Le misure dei moduli Modus sono espresse in centimetri

Modus 2.0

Back curved shelf
Mensola posteriore curva

For Modus 2.0 curved, H140 cm
Per Modus 2.0 curva, H140 cm

K_MD/2C60_M_finitura_R_50

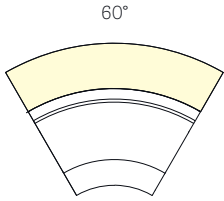

Single curved shelf, thickness 4 cm,
LAMINATE or FENIX, ABS edge in matching colour: **€ 453,00**

Mensola curva, singola, spessore 4 cm,
LAMINATO o FENIX, bordo ABS in tinta: **€ 453,00**

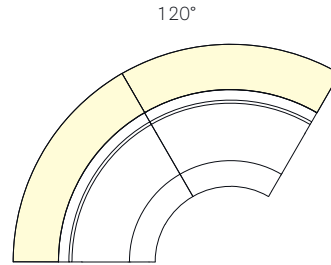

Double curved shelf, thickness 4 cm,
LAMINATE or FENIX, ABS edge in matching colour: **€ 905,00**

Mensola curva, doppia, spessore 4 cm,
LAMINATO o FENIX, bordo ABS in tinta: **€ 905,00**

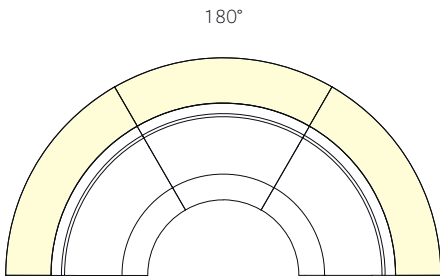

Triple curved shelf, thickness 4 cm,
LAMINATE or FENIX, ABS edge in matching colour: **€ 1.358,00**

Mensola curva, tripla, spessore 4 cm,
LAMINATO o FENIX, bordo ABS in tinta: **€ 1.358,00**

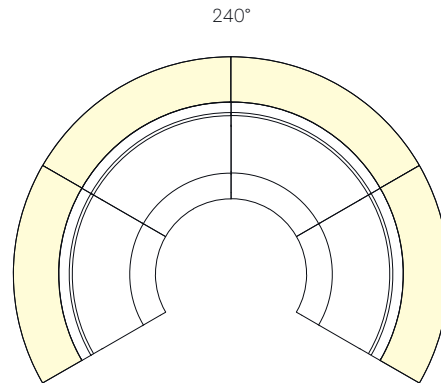

Quadruple curved shelf, thickness 4 cm,
LAMINATE or FENIX, ABS edge in matching colour: **€ 1.810,00**

Mensola curva, quadrupla, spessore 4 cm,
LAMINATO o FENIX, bordo ABS in tinta: **€ 1.810,00**

Laminate colours / Colori laminato

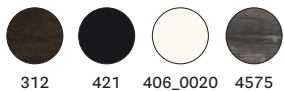

312 421 406_0020 4575

FENIX colours / Colori FENIX



0720 0029

Mood 720



SEAT Sedile	BACK Schienale	FRAME Telaio	LEATHER Cuoio
F01; F05+F09	F01; F05+F09	F01; F05+F09	€ 647,00

GENUINE LEATHER FINISHES / Finiture cuoio naturale

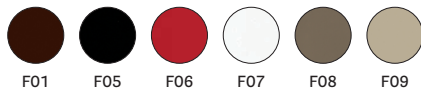

PACKING / Imballo



TECHNICAL DETAILS / Dettagli tecnici



Mya 700



SEAT Sedile	BACK Schienale	POWDER COATED Verniciato	POLISHED ALUMINIUM Alluminio lucidato	BRUSHED ALUMINIUM Alluminio satinato
PPL	PPL	€ 214,00	€ 266,00	€ 266,00

PPL FINISHES / Finiture PPL



PACKING / Imballo



TECHNICAL DETAILS / Dettagli tecnici



SAFETY, STRENGTH and DURABILITY TESTS
Prove di sicurezza, resistenza e durata
EN 1728:2000

Mya 701

TECNICA



SEAT Sedile	BACK Schienale	POWDER COATED Verniciato	POLISHED ALUMINIUM Alluminio lucidato	BRUSHED ALUMINIUM Alluminio satinato
PPL	TXT	€ 229,00	€ 281,00	€ 281,00

PPL FINISHES / Finiture PPL



TXT FINISHES / Finiture TXT

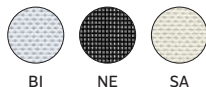

For colours and finishes see at page 320
Per colori e finiture vedere da pagina 320

PACKING / Imballo



TECHNICAL DETAILS / Dettagli tecnici



SAFETY, STRENGTH and DURABILITY TESTS
Prove di sicurezza, resistenza e durata
EN 1728:2000

Mya 702

TECNICA



SEAT Sedile	BACK Schienale	POLISHED ALUMINIUM Alluminio lucidato	BRUSHED ALUMINIUM Alluminio satinato
H20+H35; H100+H108	TXT	€ 379,00	€ 379,00
P		€ 449,00	€ 449,00

For fabrics see page 325
Per i tessuti si veda a p. 325

TXT FINISHES / Finiture TXT

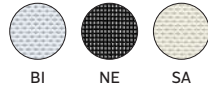

PACKING / Imballo



TECHNICAL DETAILS / Dettagli tecnici

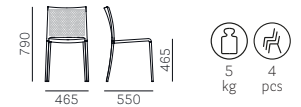

SAFETY, STRENGTH and DURABILITY TESTS
Prove di sicurezza, resistenza e durata
EN 1728:2000

Mya 710

SOFT



SEAT Sedile	BACK Schienale	POLISHED ALUMINIUM Alluminio lucidato	BRUSHED ALUMINIUM Alluminio satinato
H20+H35; H100+H108 H82+H89	H20+H35; H100+H108 H82+H89	€ 489,00	€ 489,00
P	P	€ 602,00	€ 602,00

For fabrics see page 325
Per i tessuti si veda a p. 325

PACKING / Imballo



TECHNICAL DETAILS / Dettagli tecnici



SAFETY, STRENGTH and DURABILITY TESTS
Prove di sicurezza, resistenza e durata
EN 1728:2000

Mya 706/2

TECNICA



SEAT Sedile	BACK Schienale	POWDER COATED Verniciato	BRUSHED ALUMINIUM Alluminio satinato
PPL	TXT	€ 340,00	€ 439,00

PPL FINISHES / Finiture PPL

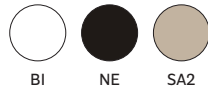

TXT FINISHES / Finiture TXT

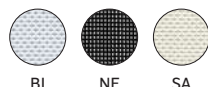

For colours and finishes see at page 320
Per colori e finiture vedere da pagina 320

PACKING / Imballo



TECHNICAL DETAILS / Dettagli tecnici

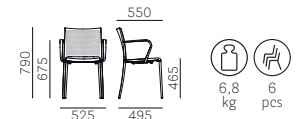

Nemea 2820



SEAT Sedile	BACK Schienale	FRAME Telaio	ASH Frassino
FR-N1-GC-BI-AN	FR-N1-GC-BI-AN	FR-N1-GC-BI-AN	€ 362,00

Black powder coated die-casted aluminum, white powder coated for FR and BI version only
 Pressofusione di alluminio verniciato nero, verniciato bianco solo per versione FR e BI

FINISHES / Finiture

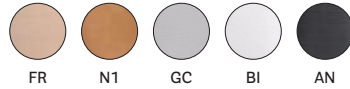

PACKING / Imballo



TECHNICAL DETAILS / Dettagli tecnici

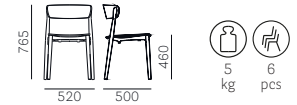

SAFETY, STRENGTH and DURABILITY TESTS
 Prove di sicurezza, resistenza e durata
 EN 1728:2012+AC2013
 EN 16139:2013 level 2



Nemea 2820



SEAT Sedile	BACK Schienale	FRAME Telaio	ASH Frassino
BL2 AZ1 VE2 VE1 RB RA MO MC	BL2 AZ1 VE2 VE1 RB RA MO MC	BL2 AZ1 VE2 VE1 RB RA MO MC	€ 376,00 Lacquered with visible grains Laccato a poro aperto

Black powder coated die-casted aluminium, powder-coated in matching colour for RB version only
 Pressofusione di alluminio verniciato nero, verniciata in tinta solo per versione RB

FINISHES / Finiture



PACKING / Imballo



TECHNICAL DETAILS / Dettagli tecnici



SAFETY, STRENGTH and DURABILITY TESTS
 Prove di sicurezza, resistenza e durata
 EN 1728:2012+AC2013
 EN 16139:2013 level 2



Nemea 2821



SEAT Sedile	BACK Schienale	FRAME Telaio	ASH Frassino
C Excluding / Escluso C36+C39 D40+D44			€ 426,00
G	FR-N1-GC-BI-AN	FR-N1-GC-BI-AN	€ 442,00
H Excluding / Escluso H140+H143			€ 471,00
P			€ 431,00
			€ 488,00

Black powder coated die-casted aluminum, white powder coated for FR and BI version only
 Pressofusione di alluminio verniciato nero, verniciato bianco solo per versione FR e BI

For fabrics see page 325
 Per i tessuti si veda a p. 325

FINISHES / Finiture



PACKING / Imballo



TECHNICAL DETAILS / Dettagli tecnici



SAFETY, STRENGTH and DURABILITY TESTS
 Prove di sicurezza, resistenza e durata
 EN 1728:2012+AC2013
 EN 16139:2013 level 2



Nemea 2825



SEAT Sedile	BACK Schienale	FRAME Telaio	ASH Frassino
FR-N1-GC-BI-AN	FR-N1-GC-BI-AN	FR-N1-GC-BI-AN	€ 381,00

Black powder coated die-casted aluminum, white powder coated for FR and BI version only
 Pressofusione di alluminio verniciato nero, verniciato bianco solo per versione FR e BI

FINISHES / Finiture

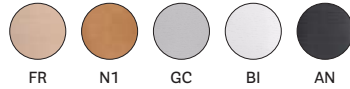

PACKING / Imballo



TECHNICAL DETAILS / Dettagli tecnici



SAFETY, STRENGTH and DURABILITY TESTS
 Prove di sicurezza, resistenza e durata
 EN 1728:2012+AC2013
 EN 16139:2013 level 2



Nemea 2825



SEAT Sedile	BACK Schienale	FRAME Telaio	ASH Frassino
BL2 AZ1 VE2 VE1 RB RA MO MC	BL2 AZ1 VE2 VE1 RB RA MO MC	BL2 AZ1 VE2 VE1 RB RA MO MC	€ 396,00 Lacquered with visible grains Laccato a poro aperto

Black powder coated die-casted aluminium, powder-coated in matching colour for RB version only
 Pressofusione di alluminio verniciato nero, verniciata in tinta solo per versione RB

FINISHES / Finiture



PACKING / Imballo



TECHNICAL DETAILS / Dettagli tecnici



SAFETY, STRENGTH and DURABILITY TESTS
 Prove di sicurezza, resistenza e durata
 EN 1728:2012+AC2013
 EN 16139:2013 level 2



Nemea 2826



SEAT Sedile	BACK Schienale	FRAME Telaio	ASH Frassino
C Excluding / Escluso C36+C39			€ 439,00
D40+D44			€ 457,00
G	FR-N1-GC-BI-AN	FR-N1-GC-BI-AN	€ 485,00
H Excluding / Escluso H140+H143			€ 444,00
P			€ 501,00

Black powder coated die-casted aluminum, white powder coated for FR and BI version only
 Pressofusione di alluminio verniciato nero, verniciato bianco solo per versione FR e BI

For fabrics see page 325
 Per i tessuti si veda a p. 325

FINISHES / Finiture



PACKING / Imballo



TECHNICAL DETAILS / Dettagli tecnici



SAFETY, STRENGTH and DURABILITY TESTS
 Prove di sicurezza, resistenza e durata
 EN 1728:2012+AC2013
 EN 16139:2013 level 2



Noa 725



SEAT Sedile	BACK Schienale	FRAME Telaio	WHITE/BLACK POWDER COATED Verniciato bianco/nero	CHROMED Cromato
C36+C39 C83+C89; C100+C101 C110+C122 C130+C141 C210+C217	C36+C39 C83+C89; C100+C101 C110+C122 C130+C141 C210+C217	Ø 16	€ 324,00	€ 324,00
G	G		€ 385,00	€ 385,00
H	H		€ 335,00	€ 335,00

Excluding / Escluso H140+H143

For fabrics see page 325
Per i tessuti si veda a p. 325

PC FINISHES / Finiture PC

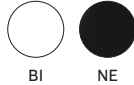

BI

NE

Polycarbonate outer shell, upholstered inner shell
Scocca esterna in policarbonato, scocca interna imbottitaSAFETY, STRENGTH and DURABILITY TESTS
Prove di sicurezza, resistenza e durata
EN 1728:2000

PACKING / Imballo



TECHNICAL DETAILS / Dettagli tecnici



Noa 727



SEAT Sedile	BACK Schienale	FRAME Telaio	WHITE/BLACK POWDER COATED Verniciato bianco/nero	POLISHED ALUMINIUM Alluminio lucidato
C36+C39 C83+C89; C100+C101 C110+C122 C130+C141 C210+C217	C36+C39 C83+C89; C100+C101 C110+C122 C130+C141 C210+C217	Ø 680	€ 432,00	€ 475,00
G	G		€ 493,00	€ 536,00
H	H		€ 442,00	€ 485,00

Excluding / Escluso H140+H143

For fabrics see page 325
Per i tessuti si veda a p. 325

PC FINISHES / Finiture PC

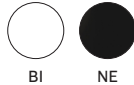

BI

NE

Polycarbonate outer shell, upholstered inner shell
Scocca esterna in policarbonato, scocca interna imbottita

PACKING / Imballo



TECHNICAL DETAILS / Dettagli tecnici



Noa 727/2



SEAT Sedile	BACK Schienale	FRAME Telaio	WHITE/BLACK POWDER COATED Verniciato bianco/nero	POLISHED ALUMINIUM Alluminio lucidato
C36+C39 C83+C89; C100+C101 C110+C122 C130+C141 C210+C217	C36+C39 C83+C89; C100+C101 C110+C122 C130+C141 C210+C217	Ø 680	€ 461,00	€ 504,00
G	G		€ 522,00	€ 565,00
H	H		€ 471,00	€ 514,00

Excluding / Escluso H140+H143

For fabrics see page 325
Per i tessuti si veda a p. 325

PC FINISHES / Finiture PC

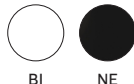

BI

NE

Polycarbonate outer shell, upholstered inner shell
Scocca esterna in policarbonato, scocca interna imbottita

PACKING / Imballo



TECHNICAL DETAILS / Dettagli tecnici



Noa 727/4

Gas lift device
Alzata a gas

SEAT Sedile	BACK Schienale	FRAME Telaio	WHITE/BLACK POWDER COATED Verniciato bianco/nero	POLISHED ALUMINIUM Alluminio lucidato
C36+C39 C83+C89; C100+C101 C110+C122 C130+C141 C210+C217	C36+C39 C83+C89; C100+C101 C110+C122 C130+C141 C210+C217	Ø 750	€ 481,00	€ 561,00
G	G		€ 543,00	€ 622,00
H	H		€ 492,00	€ 571,00
Excluding / Escluso H140+H143				
For fabrics see page 325 Per i tessuti si veda a p. 325				
PC FINISHES / Finiture PC			PACKING / Imballo	TECHNICAL DETAILS / Dettagli tecnici
			 KD MC 0,27	 12 kg
BI	NE			
Polycarbonate outer shell, upholstered inner shell Scocca esterna in policarbonato, scocca interna imbottita				

Noa 726



SEAT Sedile	BACK Schienale	FRAME Telaio	WHITE/BLACK POWDER COATED Verniciato bianco/nero	CHROMED Cromato
C36+C39 C83+C89; C100+C101 C110+C122 C130+C141 C210+C217	C36+C39 C83+C89; C100+C101 C110+C122 C130+C141 C210+C217	Ø 16	€ 459,00	€ 459,00
G	G		€ 520,00	€ 520,00
H	H		€ 470,00	€ 470,00
Excluding / Escluso H140+H143				
For fabrics see page 325 Per i tessuti si veda a p. 325				
PC FINISHES / Finiture PC			PACKING / Imballo	TECHNICAL DETAILS / Dettagli tecnici
			 MC 0,38	 8,5 kg 4 pcs
BI	NE			
Polycarbonate outer shell, upholstered inner shell Scocca esterna in policarbonato, scocca interna imbottita				

SAFETY, STRENGTH and DURABILITY TESTS
Prove di sicurezza, resistenza e durata
EN 1728:2000

Noa 728



SEAT Sedile	BACK Schienale	FRAME Telaio	WHITE/BLACK POWDER COATED Verniciato bianco/nero	POLISHED ALUMINIUM Alluminio lucidato
C36+C39 C83+C89; C100+C101 C110+C122 C130+C141 C210+C217	C36+C39 C83+C89; C100+C101 C110+C122 C130+C141 C210+C217	Ø 680	€ 566,00	€ 609,00
G	G		€ 627,00	€ 670,00
H	H		€ 576,00	€ 619,00
Excluding / Escluso H140+H143				
The armrest frame is always powder coated in white or black colour, to match the outer shell Il telaio del bracciolo è sempre verniciato bianco o nero, in tinta con la scocca esterna				
PC FINISHES / Finiture PC			PACKING / Imballo	TECHNICAL DETAILS / Dettagli tecnici
			 KD MC 0,189	 11,2 kg
BI	NE			
Polycarbonate outer shell, upholstered inner shell Scocca esterna in policarbonato, scocca interna imbottita				
For fabrics see page 325 Per i tessuti si veda a p. 325				

Noa 728/2



SEAT Sedile	BACK Schienale	FRAME Telaio	WHITE/BLACK POWDER COATED Verniciato bianco/nero	POLISHED ALUMINIUM Alluminio lucidato
C36+C39 C83+C89; C100+C101 C110+C122 C130+C141 C210+C217	C36+C39 C83+C89; C100+C101 C110+C122 C130+C141 C210+C217	Ø 680	€ 595,00	€ 637,00
G	G		€ 656,00	€ 699,00
H	H		€ 605,00	€ 648,00

Excluding / Escluso H140+H143

The armrest frame is always powder coated in white or black colour, to match the outer shell
Il telaio del bracciolo è sempre verniciato bianco o nero, in tinta con la scocca esterna

PC FINISHES / Finiture PC



BI

NE

Polycarbonate outer shell, upholstered inner shell
Scocca esterna in policarbonato, scocca interna imbottita

For fabrics see page 325
Per i tessuti si veda a p. 325

PACKING / Imballo



TECHNICAL DETAILS / Dettagli tecnici



Noa 728/4

Gas lift device
Alzata a gas



SEAT Sedile	BACK Schienale	FRAME Telaio	WHITE/BLACK POWDER COATED Verniciato bianco/nero	POLISHED ALUMINIUM Alluminio lucidato
C36+C39 C83+C89; C100+C101 C110+C122 C130+C141 C210+C217	C36+C39 C83+C89; C100+C101 C110+C122 C130+C141 C210+C217	Ø 750	€ 617,00	€ 695,00
G	G		€ 678,00	€ 756,00
H	H		€ 627,00	€ 705,00

Excluding / Escluso H140+H143

The armrest frame is always powder coated in white or black colour, to match the outer shell
Il telaio del bracciolo è sempre verniciato bianco o nero, in tinta con la scocca esterna

PC FINISHES / Finiture PC



BI

NE

Polycarbonate outer shell, upholstered inner shell
Scocca esterna in policarbonato, scocca interna imbottita

For fabrics see page 325
Per i tessuti si veda a p. 325

PACKING / Imballo



TECHNICAL DETAILS / Dettagli tecnici



Nolita 3650

Low back
Schienale basso



SEAT Sedile	BACK Schienale	FRAME Telaio	POWDER COATED Verniciato
METAL Ø 6	METAL Ø 6	METAL Ø 16	€ 151,00

FINISHES / Finiture



PACKING / Imballo



TECHNICAL DETAILS / Dettagli tecnici



SAFETY, STRENGTH and DURABILITY TESTS
Prove di sicurezza, resistenza e durata
EN 1728:2012+AC2013
EN 16139:2013 level 2

Nolita 3651

High back
Schienale alto



SEAT Sedile	BACK Schienale	FRAME Telaio	POWDER COATED Verniciato
METAL Ø 6	METAL Ø 6	METAL Ø 16	€ 163,00

FINISHES / Finiture



PACKING / Imballo



TECHNICAL DETAILS / Dettagli tecnici



SAFETY, STRENGTH and DURABILITY TESTS
Prove di sicurezza, resistenza e durata
EN 1728:2012+AC2013
EN 16139:2013 level 2

Nolita 3655

Low back
Schienale basso



SEAT Sedile	BACK Schienale	FRAME Telaio	POWDER COATED Verniciato
METAL Ø 6	METAL Ø 6	METAL Ø 16	€ 177,00

FINISHES / Finiture



PACKING / Imballo



TECHNICAL DETAILS / Dettagli tecnici

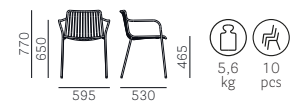

SAFETY, STRENGTH and DURABILITY TESTS
Prove di sicurezza, resistenza e durata
EN 1728:2012+AC2013
EN 16139:2013 level 2

Nolita 3656

High back
Schienale alto



SEAT Sedile	BACK Schienale	FRAME Telaio	POWDER COATED Verniciato
METAL Ø 6	METAL Ø 6	METAL Ø 16	€ 189,00

SAFETY, STRENGTH and DURABILITY TESTS
Prove di sicurezza, resistenza e durata
EN 1728:2012+AC2013
EN 16139:2013 level 2

FINISHES / Finiture



PACKING / Imballo



TECHNICAL DETAILS / Dettagli tecnici



Nolita 3650.3

Cushion only
Solo cuscino



SEAT Sedile	FABRIC Tessuto
D22+D26 D80+D89 D100+D105 D110+D114 D130	€ 86,00 For chairs/armchairs Per sedie/poltrone 3650, 3651, 3655, 3656

For fabrics see page 325
Per i tessuti si veda a p. 325

RIM COLOURS / Colori bordino

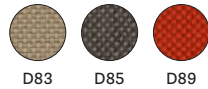

PACKING / Imballo



TECHNICAL DETAILS / Dettagli tecnici



Nolita 3657



SEAT Sedile	BACK Schienale	FRAME Telaio	POWDER COATED Verniciato
METAL Ø 6	METAL Ø 6	METAL Ø 16 H650	€ 172,00

FINISHES / Finiture



PACKING / Imballo



TECHNICAL DETAILS / Dettagli tecnici



SAFETY, STRENGTH and DURABILITY TESTS
Prove di sicurezza, resistenza e durata
EN 1728:2012+AC2013
EN 16139:2013 level 2

Nolita 3658



SEAT Sedile	BACK Schienale	FRAME Telaio	POWDER COATED Verniciato
METAL Ø 6	METAL Ø 6	METAL Ø 16 H750	€ 181,00

FINISHES / Finiture



PACKING / Imballo



TECHNICAL DETAILS / Dettagli tecnici



Nolita 3657.3

Cushion only
Solo cuscino



SEAT Sedile	FABRIC Tessuto
D22+D26 D80+D89 D100+D105 D110+D114 D130	€ 86,00 For stools Per sgabelli 3657, 3658

For fabrics see page 325
Per i tessuti si veda a p. 325

RIM COLOURS / Colori bordino

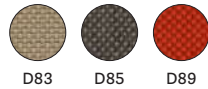

PACKING / Imballo



TECHNICAL DETAILS / Dettagli tecnici

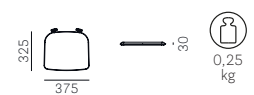

Nolita 3659

LOUNGE



SEAT Sedile	BACK Schienale	FRAME Telaio	POWDER COATED Verniciato
METAL Ø 6	METAL Ø 6	METAL Ø 16	€ 201,00

FINISHES / Finiture



PACKING / Imballo



TECHNICAL DETAILS / Dettagli tecnici



Nolita 3659.3

LOUNGE
Cushion only
Solo cuscino



SEAT
Sedile

D22+D26
D80+D89
D100+D105
D110+D114
D130

FABRIC
Tessuto

€ 86,00
For armchair
Per poltrona
3659

For fabrics see page 325
Per i tessuti si veda a p. 325

RIM COLOURS / Colori bordino

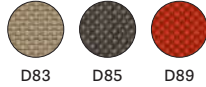

D83 D85 D89

PACKING / Imballo



TECHNICAL DETAILS / Dettagli tecnici



Nolita 3654

CHAISE LONGUE



SEAT
Sedile

METAL
Ø 6

BACK
Schienale

METAL
Ø 6

FRAME
Telaio

METAL
Ø 20

POWDER COATED
Verniciato

€ 858,00

FINISHES / Finiture



B200E G1100E AR500E RO200E TEE RA100E
NPE GAE AZ100E BL300E BL500E VE100E VE600E

PACKING / Imballo



TECHNICAL DETAILS / Dettagli tecnici

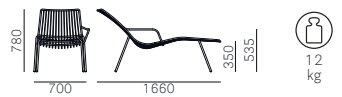

Nolita 3654.7

CHAISE LONGUE
Cushion only
Solo cuscino



SEAT
Sedile

D22+D26
D80+D89
D100+D105
D110+D114
D130

FABRIC
Tessuto

€ 480,00

For fabrics see page 325
Per i tessuti si veda a p. 325

RIM COLOURS / Colori bordino

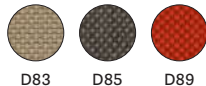

D83 D85 D89

PACKING / Imballo



TECHNICAL DETAILS / Dettagli tecnici

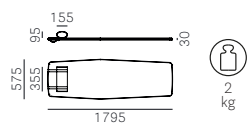

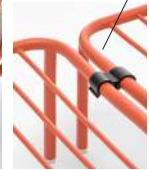

Couple of linking devices included
Inclusa una coppia di ganci di collegamento

CODE Codice	SEAT Sedile	BACK Schienale	FRAME Telaio	POWDER COATED Verniciato
DN001 Linear Lineare	D22+D26 D80+D89 D100+D105 D110+D114 D130	D22+D26 D80+D89 D100+D105 D110+D114 D130	METAL Ø 20	€ 1.495,00
DN002 Right corner (with armrest cushion) Angolare destro (con cuscino bracciolo)	D22+D26 D80+D89 D100+D105 D110+D114 D130	D22+D26 D80+D89 D100+D105 D110+D114 D130	METAL Ø 20	€ 1.885,00
DN003 Left corner (with armrest cushion) Angolare sinistro (con cuscino bracciolo)	D22+D26 D80+D89 D100+D105 D110+D114 D130	D22+D26 D80+D89 D100+D105 D110+D114 D130	METAL Ø 20	€ 1.885,00
DN004 Right corner Angolare destro	D22+D26 D80+D89 D100+D105 D110+D114 D130	D22+D26 D80+D89 D100+D105 D110+D114 D130	METAL Ø 20	€ 1.664,00
DN005 Left corner Angolare sinistro	D22+D26 D80+D89 D100+D105 D110+D114 D130	D22+D26 D80+D89 D100+D105 D110+D114 D130	METAL Ø 20	€ 1.664,00

Optional cushions available on request see page 312
Disponibili a richiesta i cuscini accessori si veda a p. 312

Optional protective covers available on request see page 314
Disponibili a richiesta le coperture protettive accessorie si veda a p. 314

FINISHES / Finiture



For fabrics see page 325
Per i tessuti si veda a p. 325

TECHNICAL DETAILS / Dettagli tecnici

DN001

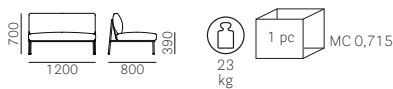

DN002

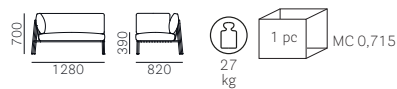

DN003



DN004

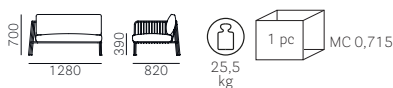

DN005



Nym 2830



SEAT Sedile	BACK Schienale	FRAME Telaio	ASH Frassino
FR-N1-GC-BI-AN	FR-N1-GC-BI-AN	FR-N1-GC-BI-AN	€ 514,00

FINISHES / Finiture



PACKING / Imballo



TECHNICAL DETAILS / Dettagli tecnici



SAFETY, STRENGTH and DURABILITY TESTS
 Prove di sicurezza, resistenza e durata
 EN 1728:2012+AC2013
 EN 16139:2013 level 2



Nym 2830



SEAT Sedile	BACK Schienale	FRAME Telaio	ASH Frassino
BL2 AZ1 VE2 VE1 RB RA MO MC	BL2 AZ1 VE2 VE1 RB RA MO MC	BL2 AZ1 VE2 VE1 RB RA MO MC	€ 530,00 Lacquered with visible grains Laccato a poro aperto

FINISHES / Finiture



PACKING / Imballo



TECHNICAL DETAILS / Dettagli tecnici



SAFETY, STRENGTH and DURABILITY TESTS
 Prove di sicurezza, resistenza e durata
 EN 1728:2012+AC2013
 EN 16139:2013 level 2



Nym 2830R



SEAT Sedile	BACK Schienale	FRAME Telaio	ASH Frassino
FR-N1-GC-BI-AN	FR-N1-GC-BI-AN	FR-N1-GC-BI-AN	€ 572,00

Reinforcing frame made of steel rod Ø10mm, black powder coated, for intensive use
 Telaio di rinforzo in tondino Ø10mm, verniciato nero, per uso intensivo

FINISHES / Finiture

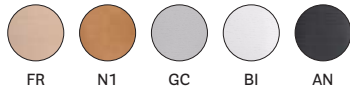

PACKING / Imballo



TECHNICAL DETAILS / Dettagli tecnici



SAFETY, STRENGTH and DURABILITY TESTS
 Prove di sicurezza, resistenza e durata
 EN 1728:2012+AC2013
 EN 16139:2013 level 2



Nym 2830R



SEAT Sedile	BACK Schienale	FRAME Telaio	ASH Frassino
BL2	BL2	BL2	€ 588,00 Lacquered with visible grains Laccato a poro aperto
AZ1	AZ1	AZ1	
VE2	VE2	VE2	
VE1	VE1	VE1	
RB	RB	RB	
RA	RA	RA	
MO	MO	MO	
MC	MC	MC	

Reinforcing frame made of steel rod Ø10mm, black powder coated, for intensive use
 Telaio di rinforzo in tondino Ø10mm, verniciato nero, per uso intensivo

FINISHES / Finiture



PACKING / Imballo



TECHNICAL DETAILS / Dettagli tecnici

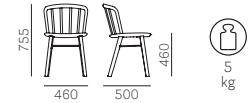

SAFETY, STRENGTH and DURABILITY TESTS
 Prove di sicurezza, resistenza e durata
 EN 1728:2012+AC2013
 EN 16139:2013 level 2

Nym 2831



SEAT Sedile	BACK Schienale	FRAME Telaio	ASH Frassino
C Excluding / Escluso C36+C39 D40+D44			€ 615,00
E			€ 634,00
G	FR-N1-GC- BI-AN	FR-N1-GC- BI-AN	€ 662,00
H Excluding / Escluso H140+H143			€ 621,00
N			€ 674,00
P			€ 679,00

For fabrics see page 325
 Per i tessuti si veda a p. 325

FINISHES / Finiture

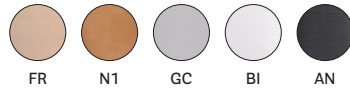

PACKING / Imballo



TECHNICAL DETAILS / Dettagli tecnici



SAFETY, STRENGTH and DURABILITY TESTS
 Prove di sicurezza, resistenza e durata
 EN 1728:2012+AC2013
 EN 16139:2013 level 2

Nym 2831R



SEAT Sedile	BACK Schienale	FRAME Telaio	ASH Frassino
C Excluding / Escluso C36+C39 D40+D44			€ 673,00
E			€ 692,00
G	FR-N1-GC- BI-AN	FR-N1-GC- BI-AN	€ 721,00
H Excluding / Escluso H140+H143			€ 721,00
N			€ 679,00
P			€ 732,00
			€ 738,00

Reinforcing frame made of steel rod Ø10mm, black powder coated, for intensive use
 Telaio di rinforzo in tondino Ø10mm, verniciato nero, per uso intensivo

FINISHES / Finiture



PACKING / Imballo



TECHNICAL DETAILS / Dettagli tecnici



SAFETY, STRENGTH and DURABILITY TESTS
 Prove di sicurezza, resistenza e durata
 EN 1728:2012+AC2013
 EN 16139:2013 level 2

For fabrics see page 325
 Per i tessuti si veda a p. 325



Nym 2832

SOFT



SEAT Sedile	BACK Schienale	FRAME Telaio	ASH Frassino
C Excluding / Escluso C36+C39 D40+D44 D120+D123	C D40+D44 D120+D123		€ 637,00
E	E	FR-N1-GC- BI-AN	€ 787,00
G	G		€ 741,00
H	H		€ 657,00

For fabrics see page 325
Per i tessuti si veda a p. 325

FINISHES / Finiture



PACKING / Imballo



TECHNICAL DETAILS / Dettagli tecnici



SAFETY, STRENGTH and DURABILITY TESTS
Prove di sicurezza, resistenza e durata
EN 1728:2012+AC2013
EN 16139:2013 level 2



Nym 2840



SEAT Sedile	BACK Schienale	FRAME Telaio	ASH Frassino
FR-N1-GC- BI-AN	FR-N1-GC- BI-AN	FR-N1-GC- BI-AN	€ 700,00

FINISHES / Finiture

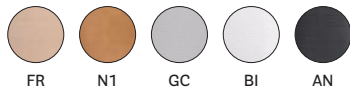

PACKING / Imballo



TECHNICAL DETAILS / Dettagli tecnici

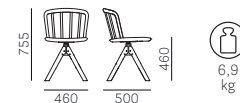

Nym 2840



SEAT Sedile	BACK Schienale	FRAME Telaio	ASH Frassino
BL2 AZ1 VE2 VE1 RB RA MO MC	BL2 AZ1 VE2 VE1 RB RA MO MC	BL2 AZ1 VE2 VE1 RB RA MO MC	€ 714,00 Lacquered with visible grains Laccato a poro aperto

FINISHES / Finiture

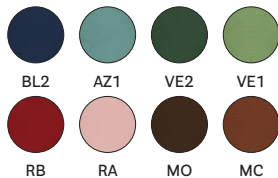

PACKING / Imballo



TECHNICAL DETAILS / Dettagli tecnici

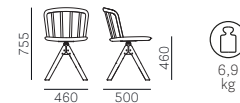

PRODUCT CERTIFIED
FOR LOW CHEMICAL
EMISSIONS:
UL.COM/GG
UL 2818



PRODUCT CERTIFIED
FOR LOW CHEMICAL
EMISSIONS:
UL.COM/GG
UL 2818

Nym 2841



SEAT Sedile	BACK Schienale	FRAME Telaio	ASH Frassino
C Excluding / Escluso C36+C39 D40+D44			€ 800,00
E			€ 818,00
G	FR-N1-GC- BI-AN	FR-N1-GC- BI-AN	€ 848,00
H Excluding / Escluso H140+H143			€ 806,00
N			€ 860,00
P			€ 864,00

For fabrics see page 325
Per i tessuti si veda a p. 325

FINISHES / Finiture



PACKING / Imballo



TECHNICAL DETAILS / Dettagli tecnici

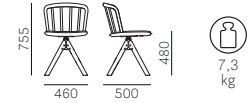

Nym 2842

SOFT



SEAT Sedile	BACK Schienale	FRAME Telaio	ASH Frassino
C Excluding / Escluso C36+C39 D40+D44 D120+D123	C D40+D44 D120+D123		€ 728,00
E	E	FR-N1-GC- BI-AN	€ 886,00
G	G		€ 838,00
H	H		€ 743,00

For fabrics see page 325
Per i tessuti si veda a p. 325

FINISHES / Finiture



PACKING / Imballo



TECHNICAL DETAILS / Dettagli tecnici



Nym 2850



SEAT Sedile	BACK Schienale	FRAME Telaio	ASH Frassino POWDER COATED Verniciato
FR-N1-GC- BI-AN	FR-N1-GC- BI-AN	Ø 11	€ 463,00

FINISHES / Finiture

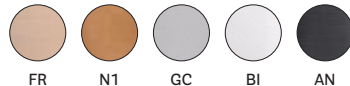

PACKING / Imballo



TECHNICAL DETAILS / Dettagli tecnici

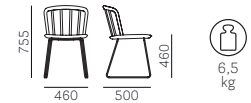

For colours and finishes see at page 320
Per colori e finiture vedere da pagina 320



PRODUCT CERTIFIED
FOR LOW CHEMICAL
EMISSIONS:
UL.COM/GG
UL 2818

Nym 2851



SEAT Sedile	BACK Schienale	FRAME Telaio	ASH Frassino POWDER COATED Verniciato
C Excluding / Escluso C36+C39 D40+D44			€565,00
E			€583,00
G	FR-N1-GC- BI-AN	Ø 11	€611,00
H Excluding / Escluso H140+H143			€611,00
N			€571,00
P			€624,00
			€628,00

For fabrics see page 325
Per i tessuti si veda a p. 325

FINISHES / Finiture



PACKING / Imballo



TECHNICAL DETAILS / Dettagli tecnici

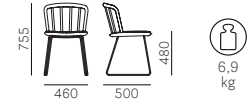

Nym 2852

SOFT



SEAT Sedile	BACK Schienale	FRAME Telaio	POWDER COATED Verniciato
C Excluding / Escluso C36+C39 D40+D44 D120+D123	C D40+D44 D120+D123		€546,00
E	E	Ø 11	€585,00
G	G		€696,00
H	H		€650,00
			€566,00

For fabrics see page 325
Per i tessuti si veda a p. 325

PACKING / Imballo



TECHNICAL DETAILS / Dettagli tecnici



Nym 2882

SOFT



SEAT Sedile	BACK Schienale	FRAME Telaio	POWDER COATED Verniciato
C Excluding / Escluso C36+C39 D40+D44 D120+D123	C D40+D44 D120+D123		€546,00
E	E	Ø 16	€585,00
G	G		€696,00
H	H		€650,00
			€566,00

For fabrics see page 325
Per i tessuti si veda a p. 325

PACKING / Imballo



TECHNICAL DETAILS / Dettagli tecnici



For colours and finishes see at page 320
Per colori e finiture vedere da pagina 320

Nym 2835



SEAT Sedile	BACK Schienale	FRAME Telaio	ASH Frassino
FR-N1-GC-BI-AN	FR-N1-GC-BI-AN	FR-N1-GC-BI-AN	€ 559,00

FINISHES / Finiture

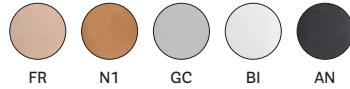

PACKING / Imballo



TECHNICAL DETAILS / Dettagli tecnici



SAFETY, STRENGTH and DURABILITY TESTS
 Prove di sicurezza, resistenza e durata
 EN 1728:2012+AC2013
 EN 16139:2013 level 2



Nym 2835



SEAT Sedile	BACK Schienale	FRAME Telaio	ASH Frassino
BL2 AZ1 VE2 VE1 RB RA MO MC	BL2 AZ1 VE2 VE1 RB RA MO MC	BL2 AZ1 VE2 VE1 RB RA MO MC	€ 574,00 Lacquered with visible grains Laccato a poro aperto

FINISHES / Finiture



PACKING / Imballo



TECHNICAL DETAILS / Dettagli tecnici



SAFETY, STRENGTH and DURABILITY TESTS
 Prove di sicurezza, resistenza e durata
 EN 1728:2012+AC2013
 EN 16139:2013 level 2



Nym 2835R



SEAT Sedile	BACK Schienale	FRAME Telaio	ASH Frassino
FR-N1-GC-BI-AN	FR-N1-GC-BI-AN	FR-N1-GC-BI-AN	€ 617,00

Reinforcing frame made of steel rod Ø10mm, black powder coated, for intensive use
 Telaio di rinforzo in tondino Ø10mm, verniciato nero, per uso intensivo

FINISHES / Finiture



PACKING / Imballo



TECHNICAL DETAILS / Dettagli tecnici



SAFETY, STRENGTH and DURABILITY TESTS
 Prove di sicurezza, resistenza e durata
 EN 1728:2012+AC2013
 EN 16139:2013 level 2



Nym 2835R



SEAT Sedile	BACK Schienale	FRAME Telaio	ASH Frassino
BL2 AZ1 VE2 VE1 RB RA MO MC	BL2 AZ1 VE2 VE1 RB RA MO MC	BL2 AZ1 VE2 VE1 RB RA MO MC	€ 632,00 Lacquered with visible grains Laccato a poro aperto

Reinforcing frame made of steel rod Ø10mm, black powder coated, for intensive use
Telaio di rinforzo in tondino Ø10mm, verniciato nero, per uso intensivo

FINISHES / Finiture



PACKING / Imballo



TECHNICAL DETAILS / Dettagli tecnici



SAFETY, STRENGTH and DURABILITY TESTS
Prove di sicurezza, resistenza e durata
EN 1728:2012+AC2013
EN 16139:2013 level 2



Nym 2836



SEAT Sedile	BACK Schienale	FRAME Telaio	ASH Frassino
C Excluding / Escluso C36+C39 D40+D44			€ 665,00
E			€ 713,00
G	FR-N1-GC- BI-AN	FR-N1-GC- BI-AN	€ 713,00
H Excluding / Escluso H140+H143			€ 671,00
N			€ 725,00
P			€ 730,00

For fabrics see page 325
Per i tessuti si veda a p. 325

FINISHES / Finiture



PACKING / Imballo



TECHNICAL DETAILS / Dettagli tecnici



SAFETY, STRENGTH and DURABILITY TESTS
Prove di sicurezza, resistenza e durata
EN 1728:2012+AC2013
EN 16139:2013 level 2



Nym 2836R



SEAT Sedile	BACK Schienale	FRAME Telaio	ASH Frassino
C Excluding / Escluso C36+C39 D40+D44			€ 723,00
E			€ 741,00
G	FR-N1-GC- BI-AN	FR-N1-GC- BI-AN	€ 771,00
H Excluding / Escluso H140+H143			€ 771,00
N			€ 730,00
P			€ 783,00
			€ 788,00

Reinforcing frame made of steel rod Ø10mm, black powder coated, for intensive use
Telaio di rinforzo in tondino Ø10mm, verniciato nero, per uso intensivo

FINISHES / Finiture



PACKING / Imballo



TECHNICAL DETAILS / Dettagli tecnici



SAFETY, STRENGTH and DURABILITY TESTS
Prove di sicurezza, resistenza e durata
EN 1728:2012+AC2013
EN 16139:2013 level 2

For fabrics see page 325
Per i tessuti si veda a p. 325



Nym 2837

SOFT



SEAT Sedile	BACK Schienale	FRAME Telaio	ASH Frassino
C Excluding / Escluso C36+C39 D40*D44 D120*D123	C D40*D44 D120*D123		€ 715,00
E	E	FR-N1-GC- BI-AN	€ 761,00
G	G		€ 891,00
H	H		€ 839,00
			€ 735,00

For fabrics see page 325
Per i tessuti si veda a p. 325

FINISHES / Finiture



PACKING / Imballo



TECHNICAL DETAILS / Dettagli tecnici

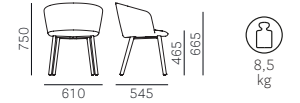

SAFETY, STRENGTH and DURABILITY TESTS
Prove di sicurezza, resistenza e durata
EN 1728:2012+AC2013
EN 16139:2013 level 2



Nym 2845



SEAT Sedile	BACK Schienale	FRAME Telaio	ASH Frassino
FR-N1-GC- BI-AN	FR-N1-GC- BI-AN	FR-N1-GC- BI-AN	€ 749,00

FINISHES / Finiture

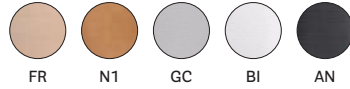

PACKING / Imballo



TECHNICAL DETAILS / Dettagli tecnici



PRODUCT CERTIFIED
FOR LOW CHEMICAL
EMISSIONS:
UL.COM/GG
UL 2818

Nym 2845



SEAT Sedile	BACK Schienale	FRAME Telaio	ASH Frassino
BL2 AZ1 VE2 VE1 RB RA MO MC	BL2 AZ1 VE2 VE1 RB RA MO MC	BL2 AZ1 VE2 VE1 RB RA MO MC	€ 765,00 Lacquered with visible grains Laccato a poro aperto

FINISHES / Finiture



PACKING / Imballo



TECHNICAL DETAILS / Dettagli tecnici

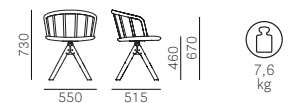

PRODUCT CERTIFIED
FOR LOW CHEMICAL
EMISSIONS:
UL.COM/GG
UL 2818

Nym 2846



SEAT Sedile	BACK Schienale	FRAME Telaio	ASH Frassino
C Excluding / Escluso C36+C39 D40+D44			€ 851,00
E			€ 869,00
G	FR-N1-GC- BI-AN	FR-N1-GC- BI-AN	€ 899,00
H Excluding / Escluso H140+H143			€ 857,00
N			€ 910,00
P			€ 914,00

For fabrics see page 325
Per i tessuti si veda a p. 325

FINISHES / Finiture

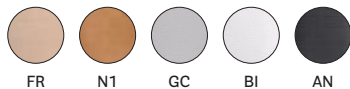

PACKING / Imballo



TECHNICAL DETAILS / Dettagli tecnici



Nym 2847

SOFT



SEAT Sedile	BACK Schienale	FRAME Telaio	ASH Frassino
C Excluding / Escluso C36+C39 D40+D44 D120+D123	C D40+D44 D120+D123		€ 797,00
E	E	FR-N1-GC- BI-AN	€ 849,00
G	G		€ 987,00
H	H		€ 816,00

For fabrics see page 325
Per i tessuti si veda a p. 325

FINISHES / Finiture

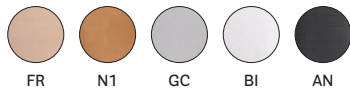

PACKING / Imballo



TECHNICAL DETAILS / Dettagli tecnici

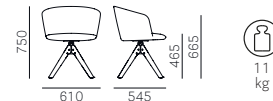

Nym 2855



SEAT Sedile	BACK Schienale	FRAME Telaio	ASH Frassino POWDER COATED Verniciato
FR-N1-GC- BI-AN	FR-N1-GC- BI-AN	Ø 11	€ 514,00

FINISHES / Finiture



PACKING / Imballo



TECHNICAL DETAILS / Dettagli tecnici

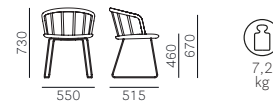

For colours and finishes see at page 320
Per colori e finiture vedere da pagina 320



PRODUCT CERTIFIED
FOR LOW CHEMICAL
EMISSIONS:
UL COM/CG
UL 2818

Nym 2856



SEAT Sedile	BACK Schienale	FRAME Telaio	ASH Frassino POWDER COATED Verniciato
C Excluding / Escluso C36+C39 D40+D44			€ 615,00
E			€ 634,00
G	FR-N1-GC- BI-AN	Ø 11	€ 662,00
H Excluding / Escluso H140+H143			€ 621,00
N			€ 674,00
P			€ 679,00

For fabrics see page 325
Per i tessuti si veda a p. 325

FINISHES / Finiture

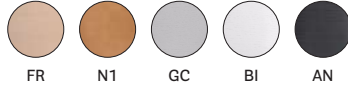

PACKING / Imballo



TECHNICAL DETAILS / Dettagli tecnici

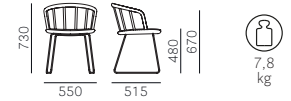

Nym 2857

SOFT



SEAT Sedile	BACK Schienale	FRAME Telaio	POWDER COATED Verniciato
C Excluding / Escluso C36+C39 D40+D44 D120+D123	C D40+D44 D120+D123		€ 624,00
E	E	Ø 11	€ 670,00
G	G		€ 800,00
H	H		€ 748,00
			€ 644,00

For fabrics see page 325
Per i tessuti si veda a p. 325

PACKING / Imballo



TECHNICAL DETAILS / Dettagli tecnici

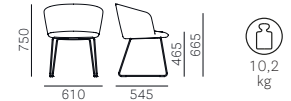

Nym 2887

SOFT



SEAT Sedile	BACK Schienale	FRAME Telaio	POWDER COATED Verniciato
C Excluding / Escluso C36+C39 D40+D44 D120+D123	C D40+D44 D120+D123		€ 624,00
E	E	Ø 16	€ 670,00
G	G		€ 800,00
H	H		€ 748,00
			€ 644,00

For fabrics see page 325
Per i tessuti si veda a p. 325

PACKING / Imballo



TECHNICAL DETAILS / Dettagli tecnici

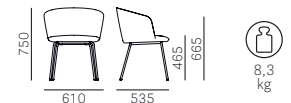

For colours and finishes see at page 320
Per colori e finiture vedere da pagina 320

Nym 2877

SOFT



SEAT Sedile	BACK Schienale	FRAME Telaio	WHITE/BLACK POWDER COATED Verniciato bianco/nero	POLISHED ALUMINIUM Alluminio lucidato
C Excluding / Escluso C36+C39 D40+D44 D40+D44 D120+D123 D120+D123	C		€ 689,00	€ 761,00
E	E	Ø 750	€ 879,00	€ 951,00
G	G		€ 819,00	€ 891,00
H	H		€ 708,00	€ 779,00

For fabrics see page 325
Per i tessuti si veda a p. 325

PACKING / Imballo



TECHNICAL DETAILS / Dettagli tecnici



Nym 2838



SEAT Sedile	BACK Schienale	FRAME Telaio	ASH Frassino
			BRUSHED S/STEEL Inox satinato
FR-N1-GC-BI-AN	FR-N1-GC-BI-AN	H655	€ 608,00

FINISHES / Finiture

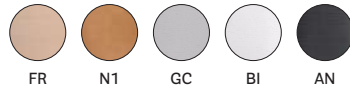

PACKING / Imballo



TECHNICAL DETAILS / Dettagli tecnici



SAFETY, STRENGTH and DURABILITY TESTS
Prove di sicurezza, resistenza e durata
EN 1728:2012+AC2013
EN 16139:2013 level 2

Nym 2838



SEAT Sedile	BACK Schienale	FRAME Telaio	ASH Frassino
			BRUSHED S/STEEL Inox satinato
BL2 AZ1 VE2 VE1 RB RA MO MC	BL2 AZ1 VE2 VE1 RB RA MO MC	H655	€ 623,00 Lacquered with visible grains Laccato a poro aperto

FINISHES / Finiture



PACKING / Imballo



TECHNICAL DETAILS / Dettagli tecnici



SAFETY, STRENGTH and DURABILITY TESTS
Prove di sicurezza, resistenza e durata
EN 1728:2012+AC2013
EN 16139:2013 level 2



Nym 2838/A



SEAT Sedile	BACK Schienale	FRAME Telaio	ASH Frassino BRUSHED S/STEEL Inox satinato
C Excluding / Escluso C36+C39 D40+D44			€ 709,00
E			€ 727,00
G	FR-N1-GC- BI-AN	H675	€ 756,00
H Excluding / Escluso H140+H143			€ 714,00
N			€ 769,00
P			€ 773,00

For fabrics see page 325
Per i tessuti si veda a p. 325

FINISHES / Finiture

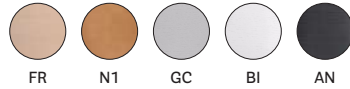

PACKING / Imballo



TECHNICAL DETAILS / Dettagli tecnici



SAFETY, STRENGTH and DURABILITY TESTS
Prove di sicurezza, resistenza e durata
EN 1728:2012+AC2013
EN 16139:2013 level 2



Nym 2839



SEAT Sedile	BACK Schienale	FRAME Telaio	ASH Frassino BRUSHED S/STEEL Inox satinato
FR-N1-GC- BI-AN	FR-N1-GC- BI-AN	H755	€ 613,00

FINISHES / Finiture

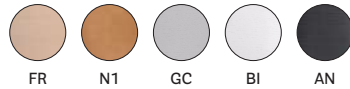

PACKING / Imballo



TECHNICAL DETAILS / Dettagli tecnici



SAFETY, STRENGTH and DURABILITY TESTS
Prove di sicurezza, resistenza e durata
EN 1728:2012+AC2013
EN 16139:2013 level 2



PRODUCT CERTIFIED
FOR LOW CHEMICAL
EMISSIONS:
UL.COM/GG
UL 2818

Nym 2839



SEAT Sedile	BACK Schienale	FRAME Telaio	ASH Frassino BRUSHED S/STEEL Inox satinato
BL2 AZ1 VE2 VE1 RB RA MO MC	BL2 AZ1 VE2 VE1 RB RA MO MC	H755	€ 628,00 Lacquered with visible grains Laccato a poro aperto

FINISHES / Finiture

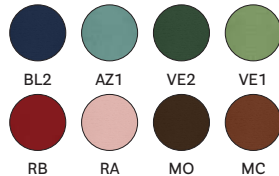

PACKING / Imballo



TECHNICAL DETAILS / Dettagli tecnici



SAFETY, STRENGTH and DURABILITY TESTS
Prove di sicurezza, resistenza e durata
EN 1728:2012+AC2013
EN 16139:2013 level 2



PRODUCT CERTIFIED
FOR LOW CHEMICAL
EMISSIONS:
UL.COM/GG
UL 2818

Nym 2839/A



SEAT Sedile	BACK Schienale	FRAME Telaio	ASH Frassino
C Excluding / Escluso C36+C39 D40+D44			BRUSHED S/STEEL Inox satinato
E	FR-N1-GC- BI-AN	H775	€714,00
G			€732,00
H Excluding / Escluso H140+H143			€762,00
N			€762,00
P			€721,00
			€774,00
			€779,00

For fabrics see page 325
Per i tessuti si veda a p. 325

FINISHES / Finiture

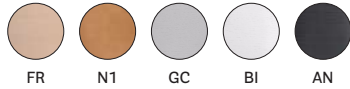

PACKING / Imballo



TECHNICAL DETAILS / Dettagli tecnici



SAFETY, STRENGTH and DURABILITY TESTS
Prove di sicurezza, resistenza e durata
EN 1728:2012+AC2013
EN 16139:2013 level 2



Nym 2848



SEAT Sedile	BACK Schienale	FRAME Telaio	ASH Frassino
			BLACK POWDER COATED Verniciato nero
FR-N1-GC- BI-AN	FR-N1-GC- BI-AN	H650	€ 751,00

FINISHES / Finiture

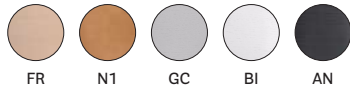

PACKING / Imballo



TECHNICAL DETAILS / Dettagli tecnici



PRODUCT CERTIFIED
FOR LOW CHEMICAL
EMISSIONS:
UL.COM/GG
UL 2818

Nym 2848



SEAT Sedile	BACK Schienale	FRAME Telaio	ASH Frassino
			BLACK POWDER COATED Verniciato nero
BL2 AZ1 VE2 VE1 RB RA MO MC	BL2 AZ1 VE2 VE1 RB RA MO MC	H650	€ 766,00 Lacquered with visible grains Laccato a poro aperto

FINISHES / Finiture

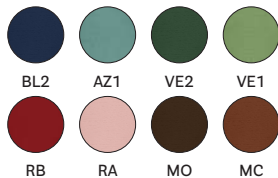

PACKING / Imballo



TECHNICAL DETAILS / Dettagli tecnici



PRODUCT CERTIFIED
FOR LOW CHEMICAL
EMISSIONS:
UL.COM/GG
UL 2818

Nym 2848/A



SEAT Sedile	BACK Schienale	FRAME Telaio	ASH Frassino
			BLACK POWDER COATED Verniciato nero
C Excluding / Escluso C36+C39 D40+D44			€ 852,00
E			€ 870,00
G	FR-N1-GC- BI-AN	H670	€ 900,00
H Excluding / Escluso H140+H143			€ 858,00
N			€ 912,00
P			€ 917,00

For fabrics see page 325
Per i tessuti si veda a p. 325

FINISHES / Finiture



PACKING / Imballo



TECHNICAL DETAILS / Dettagli tecnici



Nym 2849



SEAT Sedile	BACK Schienale	FRAME Telaio	ASH Frassino
			BLACK POWDER COATED Verniciato nero
FR-N1-GC- BI-AN	FR-N1-GC- BI-AN	H750	€ 757,00

FINISHES / Finiture

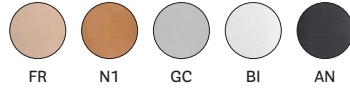

PACKING / Imballo



TECHNICAL DETAILS / Dettagli tecnici



PRODUCT CERTIFIED
FOR LOW CHEMICAL
EMISSIONS:
UL.COM/GG
UL 2818

Nym 2849



SEAT Sedile	BACK Schienale	FRAME Telaio	ASH Frassino
			BLACK POWDER COATED Verniciato nero
BL2 AZ1 VE2 VE1 RB RA MO MC	BL2 AZ1 VE2 VE1 RB RA MO MC	H750	€ 773,00 Lacquered with visible grains Laccato a poro aperto

FINISHES / Finiture

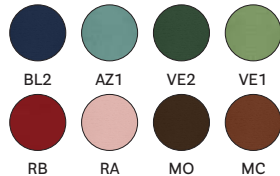

PACKING / Imballo



TECHNICAL DETAILS / Dettagli tecnici



PRODUCT CERTIFIED
FOR LOW CHEMICAL
EMISSIONS:
UL.COM/GG
UL 2818

Nym 2849/A



SEAT Sedile	BACK Schienale	FRAME Telaio	ASH Frassino BLACK POWDER COATED Verniciato nero
C Excluding / Escluso C36+C39 D40+D44			€ 858,00
E			€ 877,00
G	FR-N1-GC- BI-AN	H770	€ 907,00
H Excluding / Escluso H140+H143			€ 864,00
N			€ 918,00
P			€ 922,00

For fabrics see page 325
Per i tessuti si veda a p. 325

FINISHES / Finiture



PACKING / Imballo



TECHNICAL DETAILS / Dettagli tecnici



Nym 2858



SEAT Sedile	BACK Schienale	FRAME Telaio	ASH Frassino POWDER COATED Verniciato
FR-N1-GC- BI-AN	FR-N1-GC- BI-AN	Ø 11 H650	€ 485,00

FINISHES / Finiture

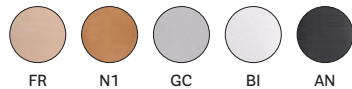

PACKING / Imballo



TECHNICAL DETAILS / Dettagli tecnici



PRODUCT CERTIFIED
FOR LOW CHEMICAL
EMISSIONS:
UL.COM/GG
UL 2818

Nym 2858/A



SEAT Sedile	BACK Schienale	FRAME Telaio	ASH Frassino POWDER COATED Verniciato
C Excluding / Escluso C36+C39 D40+D44			€ 585,00
E			€ 604,00
G	FR-N1-GC- BI-AN	Ø 11 H670	€ 634,00
H Excluding / Escluso H140+H143			€ 592,00
N			€ 645,00
P			€ 650,00

For fabrics see page 325
Per i tessuti si veda a p. 325

FINISHES / Finiture



PACKING / Imballo



TECHNICAL DETAILS / Dettagli tecnici



For colours and finishes see at page 320
Per colori e finiture vedere da pagina 320

Nym 2859



SEAT Sedile	BACK Schienale	FRAME Telaio	ASH Frassino POWDER COATED Verniciato
FR-N1-GC-BI-AN	FR-N1-GC-BI-AN	Ø 11 H750	€ 491,00

FINISHES / Finiture

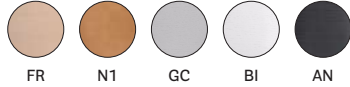

PACKING / Imballo



TECHNICAL DETAILS / Dettagli tecnici



Nym 2859/A



SEAT Sedile	BACK Schienale	FRAME Telaio	ASH Frassino POWDER COATED Verniciato
C Excluding / Escluso C36+C39 D40+D44			€ 592,00
E			€ 610,00
G	FR-N1-GC-BI-AN	Ø 11 H770	€ 640,00
H Excluding / Escluso H140+H143			€ 598,00
N			€ 652,00
P			€ 656,00

For fabrics see page 325
Per i tessuti si veda a p. 325

FINISHES / Finiture

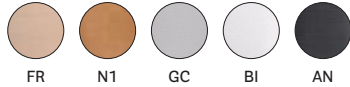

PACKING / Imballo



TECHNICAL DETAILS / Dettagli tecnici



Osaka 2810



SEAT Sedile	BACK Schienale	FRAME Telaio	ASH Frassino
FR-N1-GC-BI-AN	FR-N1-GC-BI-AN	FR-N1-GC-BI-AN	€ 348,00

FINISHES / Finiture



PACKING / Imballo



TECHNICAL DETAILS / Dettagli tecnici



SAFETY, STRENGTH and DURABILITY TESTS
 Prove di sicurezza, resistenza e durata
 EN 1728:2012+AC2013
 EN 16139:2013 level 2

Osaka 2810



SEAT Sedile	BACK Schienale	FRAME Telaio	ASH Frassino
BL2 AZ1 VE2 VE1 RB RA MO MC	BL2 AZ1 VE2 VE1 RB RA MO MC	BL2 AZ1 VE2 VE1 RB RA MO MC	€ 363,00 Lacquered with visible grains Laccato a poro aperto

FINISHES / Finiture

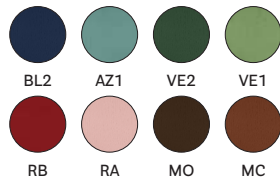

PACKING / Imballo



TECHNICAL DETAILS / Dettagli tecnici



SAFETY, STRENGTH and DURABILITY TESTS
 Prove di sicurezza, resistenza e durata
 EN 1728:2012+AC2013
 EN 16139:2013 level 2

Osaka 2811



SEAT Sedile	BACK Schienale	FRAME Telaio	ASH Frassino
C Excluding / Escluso C36+C39	C		€ 537,00
D40+D44	D40+D44		€ 582,00
G	G	FR-N1-GC-BI-AN	€ 649,00
H Excluding / Escluso H140+H143	H		€ 553,00
N	N		€ 682,00
P	P		€ 764,00

For fabrics see page 325
 Per i tessuti si veda a p. 325

Upcharge for double-colour upholstery: fabric € 13,00, leather € 43,00
 Supplemento tappezzeria bicolore: tessuto € 13,00, pelle € 43,00

FINISHES / Finiture



PACKING / Imballo



TECHNICAL DETAILS / Dettagli tecnici



SAFETY, STRENGTH and DURABILITY TESTS
 Prove di sicurezza, resistenza e durata
 EN 1728:2012+AC2013
 EN 16139:2013 level 2



Osaka 2815



SEAT Sedile	BACK Schienale	FRAME Telaio	ASH Frassino
FR-N1-GC-BI-AN	FR-N1-GC-BI-AN	FR-N1-GC-BI-AN	€ 420,00

FINISHES / Finiture

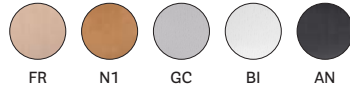

PACKING / Imballo



TECHNICAL DETAILS / Dettagli tecnici



SAFETY, STRENGTH and DURABILITY TESTS
 Prove di sicurezza, resistenza e durata
 EN 1728:2012+AC2013
 EN 16139:2013 level 2



Osaka 2815



SEAT Sedile	BACK Schienale	FRAME Telaio	ASH Frassino
BL2 AZ1 VE2 VE1 RB RA MO MC	BL2 AZ1 VE2 VE1 RB RA MO MC	BL2 AZ1 VE2 VE1 RB RA MO MC	€ 436,00 Lacquered with visible grains Laccato a poro aperto

FINISHES / Finiture



PACKING / Imballo



TECHNICAL DETAILS / Dettagli tecnici



SAFETY, STRENGTH and DURABILITY TESTS
 Prove di sicurezza, resistenza e durata
 EN 1728:2012+AC2013
 EN 16139:2013 level 2



Osaka 2816



SEAT Sedile	BACK Schienale	FRAME Telaio	ASH Frassino
C Excluding / Escluso C36+C39	C		€ 648,00
D40+D44	D40+D44		€ 699,00
G	G	FR-N1-GC-BI-AN	€ 778,00
H Excluding / Escluso H140+H143	H		€ 666,00
N	N		€ 814,00
P	P		€ 874,00

For fabrics see page 325
 Per i tessuti si veda a p. 325

Upcharge for double-colour upholstery: fabric € 13,00, leather € 65,00
 Supplemento tappezzeria bicolore: tessuto € 13,00, pelle € 65,00

FINISHES / Finiture



PACKING / Imballo



TECHNICAL DETAILS / Dettagli tecnici



SAFETY, STRENGTH and DURABILITY TESTS
 Prove di sicurezza, resistenza e durata
 EN 1728:2012+AC2013
 EN 16139:2013 level 2



Osaka Metal 5711



SEAT Sedile	BACK Schienale	FRAME Telaio	ASH Frassino			
			POWDER COATED Verniciato	GOLD LACQUERED Laccato oro	CHROMED Cromato	ANTIQU BRASS Ottone anticato
FR-MC- MO-AN	FR-MC- MO-AN	Ø 16	€ 224,00	€ 296,00	€ 224,00	€ 310,00

FINISHES / Finiture



PACKING / Imballo



TECHNICAL DETAILS / Dettagli tecnici



SAFETY, STRENGTH and DURABILITY TESTS
 Prove di sicurezza, resistenza e durata
 EN 1728:2012+AC2013
 EN 16139:2013 level 2

Osaka Metal 5714



SEAT Sedile	BACK Schienale	FRAME Telaio	ASH Frassino			
			POWDER COATED Verniciato	GOLD LACQUERED Laccato oro	CHROMED Cromato	ANTIQU BRASS Ottone anticato
FR-MC- MO-AN	FR-MC- MO-AN	Ø 11	€ 236,00	€ 307,00	€ 236,00	€ 322,00

FINISHES / Finiture



PACKING / Imballo



TECHNICAL DETAILS / Dettagli tecnici



SAFETY, STRENGTH and DURABILITY TESTS
 Prove di sicurezza, resistenza e durata
 EN 1728:2012+AC2013
 EN 16139:2013 level 2

Osaka Metal 5721

SOFT



SEAT Sedile	BACK Schienale	FRAME Telaio	POWDER COATED Verniciato	CHROMED Cromato	GOLD LACQUERED Laccato oro	ANTIQU BRASS Ottone anticato
C Excluding / Escluso D40+D44 D120+D123	C C36+C39 D40+D44 D120+D123	Ø 16	€ 397,00	€ 397,00	€ 468,00	€ 483,00
G	G		€ 436,00	€ 436,00	€ 507,00	€ 522,00
H	H		€ 498,00	€ 498,00	€ 570,00	€ 584,00
N	N		€ 411,00	€ 411,00	€ 483,00	€ 497,00
P	P		€ 527,00	€ 527,00	€ 598,00	€ 613,00
			€ 604,00	€ 604,00	€ 675,00	€ 689,00

For fabrics see page 325
 Per i tessuti si veda a p. 325

Upcharge for double-colour upholstery: fabric € 13,00, leather € 43,00
 Supplemento tappezzeria bicolore: tessuto € 13,00, pelle € 43,00

PACKING / Imballo



TECHNICAL DETAILS / Dettagli tecnici



SAFETY, STRENGTH and DURABILITY TESTS
 Prove di sicurezza, resistenza e durata
 EN 1728:2012+AC2013
 EN 16139:2013 level 2

For colours and finishes see at page 320
 Per colori e finiture vedere da pagina 320

Osaka Metal 5724

SOFT



SEAT Sedile	BACK Schienale	FRAME Telaio	POWDER COATED Verniciato	CHROMED Cromato	GOLD LACQUERED Laccato oro	ANTIQU BRASS Ottone anticato
C Excluding / Escluso C36+C39 D40+D44 D120+D123	C D40+D44 D120+D123	∅ 11	€ 407,00	€ 407,00	€ 479,00	€ 493,00
G	G		€ 448,00	€ 448,00	€ 519,00	€ 533,00
H	H		€ 510,00	€ 510,00	€ 582,00	€ 596,00
N	N		€ 422,00	€ 422,00	€ 493,00	€ 507,00
P	P		€ 539,00	€ 539,00	€ 610,00	€ 624,00
			€ 614,00	€ 614,00	€ 686,00	€ 700,00

For fabrics see page 325
Per i tessuti si veda a p. 325

Upcharge for double-colour upholstery: fabric € 13,00, leather € 43,00
Supplemento tappezzeria bicolore: tessuto € 13,00, pelle € 43,00

PACKING / Imballo

TECHNICAL DETAILS / Dettagli tecnici



SAFETY, STRENGTH and DURABILITY TESTS
Prove di sicurezza, resistenza e durata
EN 1728:2012+AC2013
EN 16139:2013 level 2

Osaka Metal 5712



SEAT Sedile	BACK Schienale	FRAME Telaio	ASH Frassino			
			POWDER COATED Verniciato	GOLD LACQUERED Laccato oro	CHROMED Cromato	ANTIQU BRASS Ottone anticato
FR-MC- MO-AN	FR-MC- MO-AN	∅ 16	€ 312,00	€ 393,00	€ 322,00	€ 407,00

Armrest finish: FR only
Finitura bracciolo: solo FR

FINISHES / Finiture



PACKING / Imballo

TECHNICAL DETAILS / Dettagli tecnici



SAFETY, STRENGTH and DURABILITY TESTS
Prove di sicurezza, resistenza e durata
EN 1728:2012+AC2013
EN 16139:2013 level 2

Osaka Metal 5715



SEAT Sedile	BACK Schienale	FRAME Telaio	ASH Frassino			
			POWDER COATED Verniciato	GOLD LACQUERED Laccato oro	CHROMED Cromato	ANTIQU BRASS Ottone anticato
FR-MC- MO-AN	FR-MC- MO-AN	∅ 11	€ 328,00	€ 418,00	€ 346,00	€ 432,00

Armrest finish: FR only
Finitura bracciolo: solo FR

FINISHES / Finiture



PACKING / Imballo

TECHNICAL DETAILS / Dettagli tecnici

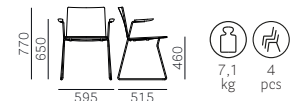

SAFETY, STRENGTH and DURABILITY TESTS
Prove di sicurezza, resistenza e durata
EN 1728:2012+AC2013
EN 16139:2013 level 2

For colours and finishes see at page 320
Per colori e finiture vedere da pagina 320



PRODUCT CERTIFIED
FOR LOW CHEMICAL
EMISSIONS:
UL.COM/GG
UL 2818

Osaka Metal 5722

SOFT



SEAT Sedile	BACK Schienale	FRAME Telaio	POWDER COATED Verniciato	GOLD LACQUERED Laccato oro	CHROMED Cromato	ANTIQU BRASS Ottone antico
C Excluding / Escluso D40+D44 D120+D123	C C36+C39 D40+D44 D120+D123	Ø 16	€ 485,00	€ 565,00	€ 493,00	€ 579,00
G	G		€ 526,00	€ 605,00	€ 533,00	€ 619,00
H	H		€ 587,00	€ 667,00	€ 596,00	€ 682,00
N	N		€ 500,00	€ 579,00	€ 507,00	€ 593,00
P	P		€ 615,00	€ 696,00	€ 624,00	€ 714,00
			€ 692,00	€ 771,00	€ 700,00	€ 786,00

Armrest finish: FR only
Finitura bracciolo: solo FR
For fabrics see page 325
Per i tessuti si veda a p. 325

Upcharge for double-colour upholstery: fabric € 13,00, leather € 43,00
Supplemento tappezzeria bicolore: tessuto € 13,00, pelle € 43,00

PACKING / Imballo



TECHNICAL DETAILS / Dettagli tecnici



SAFETY, STRENGTH and DURABILITY TESTS

Prove di sicurezza, resistenza e durata
EN 1728:2012+AC2013
EN 16139:2013 level 2



Osaka Metal 5725

SOFT



SEAT Sedile	BACK Schienale	FRAME Telaio	POWDER COATED Verniciato	GOLD LACQUERED Laccato oro	CHROMED Cromato	ANTIQU BRASS Ottone antico
C Excluding / Escluso D40+D44 D120+D123	C C36+C39 D40+D44 D120+D123	Ø 11	€ 501,00	€ 589,00	€ 518,00	€ 604,00
G	G		€ 541,00	€ 630,00	€ 558,00	€ 644,00
H	H		€ 602,00	€ 691,00	€ 619,00	€ 705,00
N	N		€ 515,00	€ 604,00	€ 532,00	€ 618,00
P	P		€ 632,00	€ 721,00	€ 649,00	€ 739,00
			€ 708,00	€ 796,00	€ 725,00	€ 810,00

Armrest finish: FR only
Finitura bracciolo: solo FR
For fabrics see page 325
Per i tessuti si veda a p. 325

Upcharge for double-colour upholstery: fabric € 13,00, leather € 43,00
Supplemento tappezzeria bicolore: tessuto € 13,00, pelle € 43,00

PACKING / Imballo



TECHNICAL DETAILS / Dettagli tecnici



SAFETY, STRENGTH and DURABILITY TESTS

Prove di sicurezza, resistenza e durata
EN 1728:2012+AC2013
EN 16139:2013 level 2



Osaka Metal 5716



SEAT Sedile	BACK Schienale	FRAME Telaio	ASH Frassino			
			POWDER COATED Verniciato	GOLD LACQUERED Laccato oro	CHROMED Cromato	ANTIQU BRASS Ottone antico
FR-MC- MO-AN	FR-MC- MO-AN	Ø 11 H650	€ 241,00	€ 318,00	€ 246,00	€ 338,00

FINISHES / Finiture



PACKING / Imballo



TECHNICAL DETAILS / Dettagli tecnici

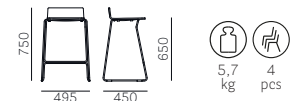

For colours and finishes see at page 320
Per colori e finiture vedere da pagina 320



Osaka Metal 5717

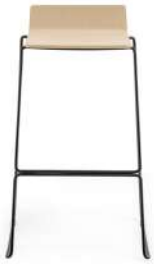

SEAT Sedile	BACK Schienale	FRAME Telaio	ASH Frassino			
			POWDER COATED Verniciato	GOLD LACQUERED Laccato oro	CHROMED Cromato	ANTIQU BRASS Ottone antico
FR-MC- MO-AN	FR-MC- MO-AN	Ø 11 H750	€ 244,00	€ 320,00	€ 249,00	€ 341,00

FINISHES / Finiture



PACKING / Imballo



TECHNICAL DETAILS / Dettagli tecnici

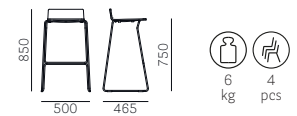

Osaka Metal 5729

SOFT
LOUNGE



SEAT Sedile	BACK Schienale	FRAME Telaio	POWDER COATED Verniciato	GOLD LACQUERED Laccato oro
			C Excluding / Escluso D40+D44 D120+D123	C C36+C39 D40+D44 D120+D123
G	G	€ 634,00	€ 705,00	
H	H	€ 710,00	€ 782,00	
N	N	€ 600,00	€ 671,00	
P	P	€ 747,00	€ 818,00	
		€ 829,00	€ 900,00	

Armrest finish: FR only
Finitura bracciolo: solo FR

For fabrics see page 325
Per i tessuti si veda a p. 325

Upcharge for double-colour upholstery: fabric € 13,00, leather € 43,00
Supplemento tappezzeria bicolore: tessuto € 13,00, pelle € 43,00

PACKING / Imballo



TECHNICAL DETAILS / Dettagli tecnici



SAFETY, STRENGTH and DURABILITY TESTS
Prove di sicurezza, resistenza e durata
EN 1728:2012+AC2013
EN 16139:2013 level 2

Panarea 3675



SEAT Sedile	BACK Schienale	FRAME Telaio	POWDER COATED Verniciato
D22+D26 D110+D114 D130	Ø 20 + Cord/Corda	Ø 20	€ 598,00

For fabrics see page 325
Per i tessuti si veda a p. 325

CORD FINISHES / Finiture corda



POWDER COATED FINISHES / Finiture verniciato



For colours and finishes see at page 320
Per colori e finiture vedere da pagina 320

PACKING / Imballo



TECHNICAL DETAILS / Dettagli tecnici



SAFETY, STRENGTH and DURABILITY TESTS
Prove di sicurezza, resistenza e durata
EN 1728:2012+AC2013
EN 581-1:2017

Panarea 3675.8

Cushion only
Solo cuscino



BACK Schienale	FABRIC Tessuto
D22+D26 D110+D114 D130	€ 94,00

For fabrics see page 325
Per i tessuti si veda a p. 325

TECHNICAL DETAILS / Dettagli tecnici

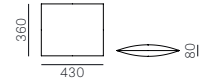

Panarea 3678



SEAT Sedile	BACK Schienale	FRAME Telaio	POWDER COATED Verniciato
D22+D26 D110+D114 D130	Ø 20 + Cord/Corda	Ø 20 H770	€ 676,00

For fabrics see page 325
Per i tessuti si veda a p. 325

CORD FINISHES / Finiture corda



POWDER COATED FINISHES / Finiture verniciato



BE100E TEE NPE BL400E

PACKING / Imballo



TECHNICAL DETAILS / Dettagli tecnici



Panarea 3679

LOUNGE



SEAT Sedile	BACK Schienale	FRAME Telaio	POWDER COATED Verniciato
D22+D26 D110+D114 D130	Ø 20 + Cord/Corda	Ø 20	€ 1.143,00

For fabrics see page 325
Per i tessuti si veda a p. 325

CORD FINISHES / Finiture corda



POWDER COATED FINISHES / Finiture verniciato



BE100E TEE NPE BL400E

PACKING / Imballo



TECHNICAL DETAILS / Dettagli tecnici



SAFETY, STRENGTH and DURABILITY TESTS
Prove di sicurezza, resistenza e durata
EN 1728:2012+AC2013
EN 581-1:2017

Pasha 660



SEAT Sedile	BACK Schienale	FRAME Telaio
PC	PC	PC

POLYCARBONATE
Policarbonato

€ 301,00

PC FINISHES / Finiture PC



BI

TR

FU



NE

SAFETY, STRENGTH and DURABILITY TESTS
Prove di sicurezza, resistenza e durata
EN 1728:2000

PACKING / Imballo



TECHNICAL DETAILS / Dettagli tecnici

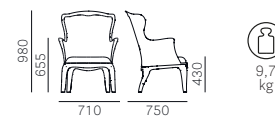

Pasha 660/CL1

Fire retardant version
Versione ignifuga



SEAT Sedile	BACK Schienale	FRAME Telaio
PC	PC	PC

POLYCARBONATE
Policarbonato

€ 346,00

Minimum order 200 pcs each colour
Ordine minimo 200 pz per colore

PC FINISHES / Finiture PC



BI

TR

SAFETY, STRENGTH and DURABILITY TESTS
Prove di sicurezza, resistenza e durata
EN 1728:2000

PACKING / Imballo



TECHNICAL DETAILS / Dettagli tecnici

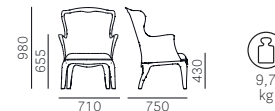

Pasha 660.3

Cushion only
Solo cuscino



SEAT Sedile
C36÷C39 fabric / tessuto
D80÷D89 fabric / tessuto
H40÷H53 velvet / velluto

FABRIC
Tessuto

€ 176,00

€ 172,00

€ 150,00

For fabrics see page 325
Per i tessuti si veda a p. 325

PACKING / Imballo



TECHNICAL DETAILS / Dettagli tecnici



Pasha 660.8

Fabric covering only
Solo vestina



SEAT Sedile	BACK Schienale	FRAME Telaio	FABRIC Tessuto
A10	A10	A10	€ 227,00

COVERING FINISHES / Finiture vestina



A10

RIM FINISHES / Finiture bordino



A10

PACKING / Imballo



MC 0,056

TECHNICAL DETAILS / Dettagli tecnici



Pasha 661

POUF



SEAT Sedile	FRAME Telaio	POLYCARBONATE Policarbonato
PC	PC	€ 137,00

PC FINISHES / Finiture PC



BI

TR

FU



NE

PACKING / Imballo



MC 0,21

TECHNICAL DETAILS / Dettagli tecnici



Pasha 661/CL1

POUF
Fire retardant version
Versione ignifuga



SEAT Sedile	FRAME Telaio	POLYCARBONATE Policarbonato
PC	PC	€ 158,00

Minimum order 200 pcs each colour
Ordine minimo 200 pz per colore

PC FINISHES / Finiture PC



BI

TR

PACKING / Imballo



MC 0,21

TECHNICAL DETAILS / Dettagli tecnici

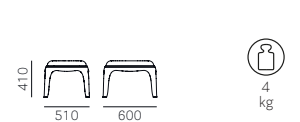

Pasha 662

Tray only
Solo vassoio



SEAT Sedile	FRAME Telaio	THERMOFORMED METHACRYLATE Metacrilato termoformato
ME	ME	€ 156,00

ME FINISHES / Finiture ME



BI



NE

PACKING / Imballo



TECHNICAL DETAILS / Dettagli tecnici

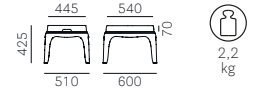

Pasha 663

Floating tray
Vassoio galleggiante



SEAT Sedile	FRAME Telaio	THERMOFORMED METHACRYLATE Metacrilato termoformato
ME	ME	€ 169,00

ME FINISHES / Finiture ME



BI

PACKING / Imballo



TECHNICAL DETAILS / Dettagli tecnici



Plural

Without armrests
Senza braccioli



P020_USB

USB optional kit
integrated into the top
Kit USB accessorio
integrato nel ripiano



CODE Codice	SEAT Sedile	BACK Schienale	POWDER COATED Verniciato	CHROMED Cromato
P02003	PPL	PPL	€ 1.109,00	€ 1.502,00
	Floor fixing kit: surcharge € 72,00 (Item P02003_FIX) Kit di fissaggio a terra: supplemento € 72,00 (Art.P02003_FIX)			
P02004	PPL	PPL	€ 1.302,00	€ 1.859,00
	Floor fixing kit: surcharge € 72,00 (Item P02004_FIX) Kit di fissaggio a terra: supplemento € 72,00 (Art.P02004_FIX)			
P02006	PPL	PPL	€ 2.002,00	€ 2.646,00
	Floor fixing kit: surcharge € 108,00 (Item P02006_FIX) Kit di fissaggio a terra: supplemento € 108,00 (Art.P02006_FIX)			
P02009	PPL	PPL	€ 2.860,00	€ 3.761,00
	Floor fixing kit: surcharge € 143,00 (Item P02009_FIX) Kit di fissaggio a terra: supplemento € 143,00 (Art.P02009_FIX)			
P020_USB	USB kit: surcharge € 101,00 (electrification excluded) Kit USB: supplemento € 101,00 (elettrificazione esclusa)			

SAFETY, STRENGTH and DURABILITY TESTS

Prove di sicurezza, resistenza e durata

EN 1728:2012+AC2013

EN 16139:2013 level 2

(for P02003 - P02004)

PPL FINISHES / Finiture PPL



BI

NE

BE

For colours and finishes see at page 320
Per colori e finiture vedere da pagina 320

TECHNICAL DETAILS / Dettagli tecnici

P02003

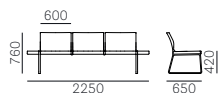

1 pc KD
MC 0,395

37
kg

P02004

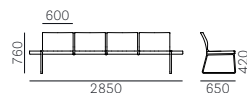

1 pc KD
MC 0,4

47
kg

P02006

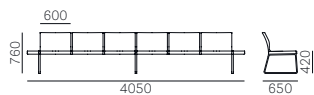

1 pc KD
MC 0,73

68
kg

P02009

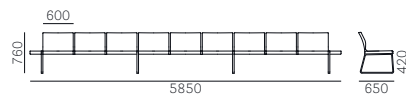

1 pc KD
MC 1,04

99
kg

Plural

With armrests
Con braccioli



CODE Codice	SEAT Sedile	BACK Schienale	POWDER COATED Verniciato	CHROMED Cromato
P02013	PPL	PPL	€ 1.230,00	€ 1.845,00
	Floor fixing kit: surcharge € 72,00 (Item P02013_FIX) Kit di fissaggio a terra: supplemento € 72,00 (Art.P02013_FIX)			
P02014	PPL	PPL	€ 1.453,00	€ 2.217,00
	Floor fixing kit: surcharge € 72,00 (Item P02014_FIX) Kit di fissaggio a terra: supplemento € 72,00 (Art.P02014_FIX)			
P02016	PPL	PPL	€ 2.145,00	€ 3.189,00
	Floor fixing kit: surcharge € 108,00 (Item P02016_FIX) Kit di fissaggio a terra: supplemento € 108,00 (Art.P02016_FIX)			
P02019	PPL	PPL	€ 3.075,00	€ 4.519,00
	Floor fixing kit: surcharge € 143,00 (Item P02019_FIX) Kit di fissaggio a terra: supplemento € 143,00 (Art.P02019_FIX)			
P020_USB	USB kit: surcharge € 101,00 (electrification excluded) Kit USB: supplemento € 101,00 (elettrificazione esclusa)			

SAFETY, STRENGTH and DURABILITY TESTS

Prove di sicurezza, resistenza e durata

EN 1728:2012+AC2013

EN 16139:2013 level 2

(for P02013 - P02014)

PPL FINISHES / Finiture PPL



BI

NE

BE

For colours and finishes see at page 320
Per colori e finiture vedere da pagina 320

TECHNICAL DETAILS / Dettagli tecnici

P02013

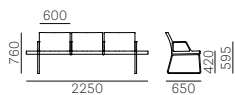

1 pc KD
39,5 kg MC 0,42

P02014

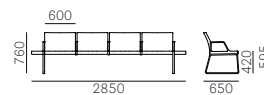

1 pc KD
50 kg MC 0,42

P02016

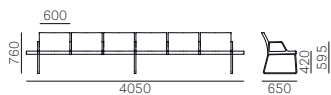

1 pc KD
72 kg MC 0,81

P02019



1 pc KD
104,5 kg MC 1,08

Plural

With outside armrests
Con braccioli esterni



P020_USB

USB optional kit
integrated into the top
Kit USB accessorio
integrato nel ripiano



CODE Codice	SEAT Sedile	BACK Schienale	POWDER COATED Verniciato	CHROMED Cromato
P02023	PPL	PPL	€ 1.202,00	€ 1.745,00
	Floor fixing kit: surcharge € 72,00 (Item P02023_FIX) Kit di fissaggio a terra: supplemento € 72,00 (Art.P02023_FIX)			
P02024	PPL	PPL	€ 1.424,00	€ 2.060,00
	Floor fixing kit: surcharge € 72,00 (Item P02024_FIX) Kit di fissaggio a terra: supplemento € 72,00 (Art.P02024_FIX)			
P02026	PPL	PPL	€ 2.060,00	€ 2.860,00
	Floor fixing kit: surcharge € 108,00 (Item P02026_FIX) Kit di fissaggio a terra: supplemento € 108,00 (Art.P02026_FIX)			
P02029	PPL	PPL	€ 2.932,00	€ 3.976,00
	Floor fixing kit: surcharge € 143,00 (Item P02029_FIX) Kit di fissaggio a terra: supplemento € 143,00 (Art.P02029_FIX)			
P020_USB	USB kit: surcharge € 101,00 (electrification excluded) Kit USB: supplemento € 101,00 (elettrificazione esclusa)			

SAFETY, STRENGTH and DURABILITY TESTS

Prove di sicurezza, resistenza e durata

EN 1728:2012+AC2013

EN 16139:2013 level 2

(for P02023 - P02024)

PPL FINISHES / Finiture PPL



BI

NE

BE

For colours and finishes see at page 320
Per colori e finiture vedere da pagina 320

TECHNICAL DETAILS / Dettagli tecnici

P02023

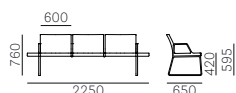

38,5
kg



1 pc



KD



MC 0,395

P02024

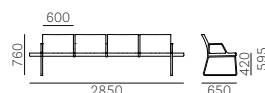

48
kg



1 pc



KD



MC 0,4

P02026

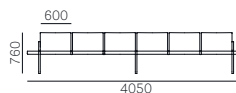

69,5
kg



1 pc



KD



MC 0,73

P02029

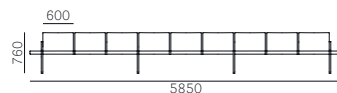

101
kg



1 pc



KD



MC 1,04

Plural

SOFT
Without armrests
Senza braccioli



P020_USB

USB optional kit
integrated into the top
Kit USB accessorio
integrato nel ripiano



CODE Codice	SEAT Sedile	BACK Schienale	POWDER COATED Verniciato	CHROMED Cromato
P02103	C *	PPL	€ 1.572,00	€ 1.966,00
	D40+D44		€ 1.620,00	€ 2.013,00
	G		€ 1.697,00	€ 2.091,00
	H *		€ 1.590,00	€ 1.983,00
Floor fixing kit: surcharge € 72,00 (Item P02103_FIX) Kit di fissaggio a terra: supplemento € 72,00 (Art.P02103_FIX)				
P02104	C *	PPL	€ 1.921,00	€ 2.478,00
	D40+D44		€ 1.983,00	€ 2.541,00
	G		€ 2.086,00	€ 2.643,00
	H *		€ 1.943,00	€ 2.500,00
Floor fixing kit: surcharge € 72,00 (Item P02104_FIX) Kit di fissaggio a terra: supplemento € 72,00 (Art.P02104_FIX)				
P02106	C *	PPL	€ 2.929,00	€ 3.573,00
	D40+D44		€ 3.024,00	€ 3.668,00
	G		€ 3.179,00	€ 3.822,00
	H *		€ 2.964,00	€ 3.608,00
Floor fixing kit: surcharge € 108,00 (Item P02106_FIX) Kit di fissaggio a terra: supplemento € 108,00 (Art.P02106_FIX)				
P02109	C *	PPL	€ 4.251,00	€ 5.152,00
	D40+D44		€ 4.393,00	€ 5.294,00
	G		€ 4.625,00	€ 5.525,00
	H *		€ 4.302,00	€ 5.203,00
Floor fixing kit: surcharge € 143,00 (Item P02109_FIX) Kit di fissaggio a terra: supplemento € 143,00 (Art.P02109_FIX)				
P020_USB	USB kit: surcharge € 101,00 (electrification excluded) Kit USB: supplemento € 101,00 (elettrificazione esclusa)			

*Excluding / Escluso C36+C39, H140+H143

PPL FINISHES / Finiture PPL



For fabrics see page 325
Per i tessuti si veda a p. 325

For colours and finishes see at page 320
Per colori e finiture vedere da pagina 320

SAFETY, STRENGTH and DURABILITY TESTS

Prove di sicurezza, resistenza e durata
EN 1728:2012+AC2013
EN 16139:2013 level 2
(for P02103 - P02104)

TECHNICAL DETAILS / Dettagli tecnici

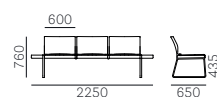

P02104

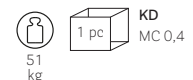
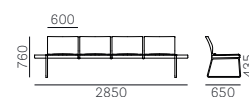

P02106

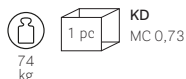
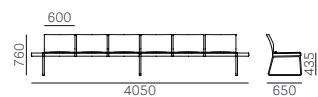

P02109

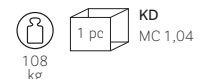
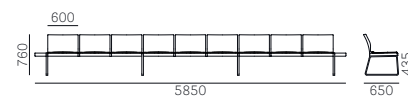

Plural

SOFT
With armrests
Con braccioli



P020_USB
USB optional kit
integrated into the top
Kit USB accessorio
integrato nel ripiano

CODE Codice	SEAT Sedile	BACK Schienale	POWDER COATED Verniciato	CHROMED Cromato
P02113	C *	PPL	€ 1.694,00	€ 2.309,00
	D40+D44		€ 1.741,00	€ 2.356,00
	G		€ 1.819,00	€ 2.434,00
	H *		€ 1.711,00	€ 2.326,00
Floor fixing kit: surcharge € 72,00 (Item P02113_FIX) Kit di fissaggio a terra: supplemento € 72,00 (Art.P02113_FIX)				
P02114	C *	PPL	€ 2.070,00	€ 2.836,00
	D40+D44		€ 2.134,00	€ 2.898,00
	G		€ 2.236,00	€ 3.001,00
	H *		€ 2.093,00	€ 2.858,00
Floor fixing kit: surcharge € 72,00 (Item P02114_FIX) Kit di fissaggio a terra: supplemento € 72,00 (Art.P02114_FIX)				
P02116	C *	PPL	€ 3.072,00	€ 4.116,00
	D40+D44		€ 3.167,00	€ 4.211,00
	G		€ 3.322,00	€ 4.366,00
	H *		€ 3.107,00	€ 4.151,00
Floor fixing kit: surcharge € 108,00 (Item P02116_FIX) Kit di fissaggio a terra: supplemento € 108,00 (Art.P02116_FIX)				
P02119	C *	PPL	€ 4.466,00	€ 5.910,00
	D40+D44		€ 4.608,00	€ 6.052,00
	G		€ 4.839,00	€ 6.283,00
	H *		€ 4.517,00	€ 5.961,00
Floor fixing kit: surcharge € 143,00 (Item P02119_FIX) Kit di fissaggio a terra: supplemento € 143,00 (Art.P02119_FIX)				
P020_USB	USB kit: surcharge € 101,00 (electrification excluded) Kit USB: supplemento € 101,00 (elettrificazione esclusa)			

*Excluding / Escluso C36+C39, H140+H143

PPL FINISHES / Finiture PPL

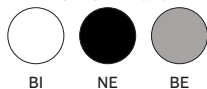

For fabrics see page 325
Per i tessuti si veda a p. 325

For colours and finishes see at page 320
Per colori e finiture vedere da pagina 320

SAFETY, STRENGTH and DURABILITY TESTS

Prove di sicurezza, resistenza e durata
EN 1728:2012+AC2013
EN 16139:2013 level 2
(for P02113 - P02114)

TECHNICAL DETAILS / Dettagli tecnici

P02113

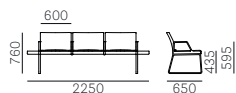

P02114

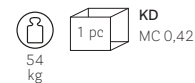
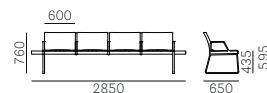

P02116

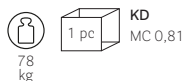
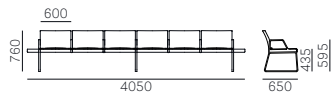

P02119

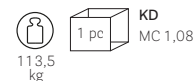
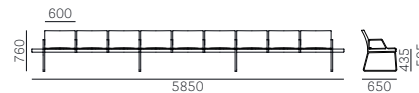

Plural

SOFT
With outside armrests
Con braccioli esterni



CODE Codice	SEAT Sedile	BACK Schienale	POWDER COATED Verniciato	CHROMED Cromato
P02123	C *	PPL	€ 1.666,00	€ 2.209,00
	D40+D44		€ 1.713,00	€ 2.256,00
	G		€ 1.791,00	€ 2.334,00
	H *		€ 1.683,00	€ 2.226,00
Floor fixing kit: surcharge € 72,00 (Item P02123_FIX) Kit di fissaggio a terra: supplemento € 72,00 (Art.P02123_FIX)				
P02124	C *	PPL	€ 2.041,00	€ 2.678,00
	D40+D44		€ 2.105,00	€ 2.741,00
	G		€ 2.208,00	€ 2.844,00
	H *		€ 2.065,00	€ 2.701,00
Floor fixing kit: surcharge € 72,00 (Item P02124_FIX) Kit di fissaggio a terra: supplemento € 72,00 (Art.P02124_FIX)				
P02126	C *	PPL	€ 2.987,00	€ 3.787,00
	D40+D44		€ 3.081,00	€ 3.882,00
	G		€ 3.236,00	€ 4.037,00
	H *		€ 3.022,00	€ 3.822,00
Floor fixing kit: surcharge € 108,00 (Item P02126_FIX) Kit di fissaggio a terra: supplemento € 108,00 (Art.P02126_FIX)				
P02129	C *	PPL	€ 4.323,00	€ 5.367,00
	D40+D44		€ 4.465,00	€ 5.509,00
	G		€ 4.696,00	€ 5.740,00
	H *		€ 4.374,00	€ 5.418,00
Floor fixing kit: surcharge € 143,00 (Item P02129_FIX) Kit di fissaggio a terra: supplemento € 143,00 (Art.P02129_FIX)				
P020_USB	USB kit: surcharge € 101,00 (electrification excluded) Kit USB: supplemento € 101,00 (elettrificazione esclusa)			

*Excluding / Escluso C36+C39, H140+H143

PPL FINISHES / Finiture PPL

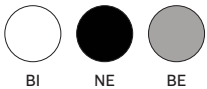

For fabrics see page 325
Per i tessuti si veda a p. 325

For colours and finishes see at page 320
Per colori e finiture vedere da pagina 320

SAFETY, STRENGTH and DURABILITY TESTS

Prove di sicurezza, resistenza e durata
EN 1728:2012+AC2013
EN 16139:2013 level 2
(for P02123 - P02124)

TECHNICAL DETAILS / Dettagli tecnici

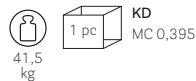
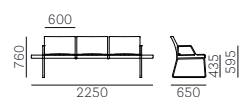

P02124

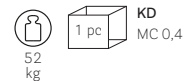
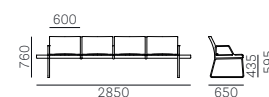

P02126

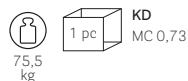
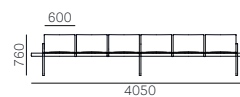

P02129

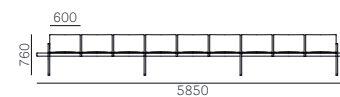

Plus 630



SEAT Sedile	BACK Schienale	FRAME Telaio	POLYPROPYLENE Polipropilene
PPL	PPL	PPL	€ 114,00

PPL FINISHES / Finiture PPL



SAFETY, STRENGTH and DURABILITY TESTS
 Prove di sicurezza, resistenza e durata
 EN 1728:2000

PACKING / Imballo



TECHNICAL DETAILS / Dettagli tecnici

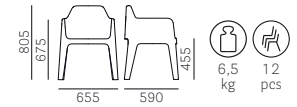

Plus 630.3

Cushion only
 Solo cuscino



SEAT Sedile	FABRIC Tessuto
D22+D26 D80+D89 D100+D105 D110+D114 D130	€ 141,00

For fabrics see page 325
 Per i tessuti si veda a p. 325

PACKING / Imballo



TECHNICAL DETAILS / Dettagli tecnici

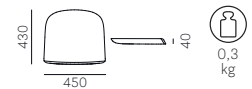

Plus Air 631

LOUNGE



SEAT Sedile	BACK Schienale	FRAME Telaio	POLYETHYLENE Polietilene
PET	PET	PET	€ 345,00

PET FINISHES / Finiture PET

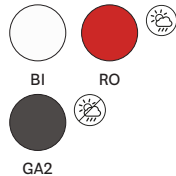

SAFETY, STRENGTH and DURABILITY TESTS
 Prove di sicurezza, resistenza e durata
 EN 1728:2000

PACKING / Imballo



TECHNICAL DETAILS / Dettagli tecnici

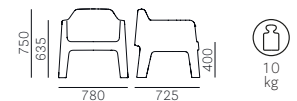

Plus Air 631.3

Cushion only
Solo cuscino



SEAT Sedile	FABRIC Tessuto
D22+D26 D80+D89 D100+D105 D110+D114 D130	€ 163,00

For fabrics see page 325
Per i tessuti si veda a p. 325

PACKING / Imballo



TECHNICAL DETAILS / Dettagli tecnici



Plus Air 636

SOFA



SEAT Sedile	BACK Schienale	FRAME Telaio	POLYETHYLENE Polietilene
PET	PET	PET	€ 652,00

PET FINISHES / Finiture PET

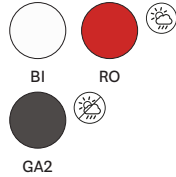

SAFETY, STRENGTH and DURABILITY TESTS
Prove di sicurezza, resistenza e durata
EN 1728:2000

PACKING / Imballo



TECHNICAL DETAILS / Dettagli tecnici

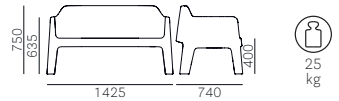

Plus Air 636.3

Cushion only
Solo cuscino



SEAT Sedile	FABRIC Tessuto
D22+D26 D80+D89 D100+D105 D110+D114 D130	€ 271,00

For fabrics see page 325
Per i tessuti si veda a p. 325

PACKING / Imballo



TECHNICAL DETAILS / Dettagli tecnici

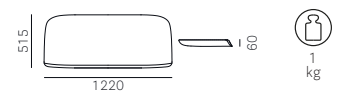

Polar 3770

Polypropylene lumbar support
Supporto lombare in polipropilene



SEAT Sedile	BACK Schienale	FRAME Telaio	BLACK POWDER COATED Verniciato nero	WHITE POWDER COATED Verniciato bianco
C83+C89; C100+C101 C110+C122 C210+C217	Mesh/Rete	Ø 750	€ 572,00	€ 637,00
G59+G78; G190+G197 G140+G146 G160+G169 G170+G176; G210+G213			€ 631,00	€ 696,00
H60+H61 H120+H127			€ 585,00	€ 650,00

For fabrics see page 325
Per i tessuti si veda a p. 325

PPL FINISHES / Finiture PPL

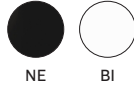

PACKING / Imballo



TECHNICAL DETAILS / Dettagli tecnici



Polar 3771

Upholstered lumbar support
Supporto lombare imbottito



SEAT Sedile	BACK Schienale	FRAME Telaio	BLACK POWDER COATED Verniciato nero	WHITE POWDER COATED Verniciato bianco
C83+C89; C100+C101 C110+C122 C210+C217	Mesh/Rete	Ø 750	€ 650,00	€ 715,00
G59+G78; G190+G197 G140+G146 G160+G169 G170+G176; G210+G213			€ 728,00	€ 793,00
H60+H61 H120+H127			€ 663,00	€ 728,00

For fabrics see page 325
Per i tessuti si veda a p. 325

PACKING / Imballo



TECHNICAL DETAILS / Dettagli tecnici



Polar 3775

Polypropylene lumbar support
Supporto lombare in polipropilene



SEAT Sedile	BACK Schienale	FRAME Telaio	BLACK POWDER COATED Verniciato nero	WHITE POWDER COATED Verniciato bianco
C83+C89; C100+C101 C110+C122 C210+C217	Mesh/Rete	Ø 750	€ 650,00	€ 728,00
G59+G78; G190+G197 G140+G146 G160+G169 G170+G176; G210+G213			€ 709,00	€ 787,00
H60+H61 H120+H127			€ 663,00	€ 741,00

For fabrics see page 325
Per i tessuti si veda a p. 325

PPL FINISHES / Finiture PPL

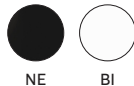

PACKING / Imballo



TECHNICAL DETAILS / Dettagli tecnici



Polar 3776

Upholstered lumbar support
Supporto lombare imbottito



SEAT Sedile	BACK Schienale	FRAME Telaio	BLACK POWDER COATED Verniciato nero	WHITE POWDER COATED Verniciato bianco
C83+C89; C100+C101 C110+C122 C210+C217	Mesh/Rete	Ø 750	€ 728,00	€ 806,00
G59+G78; G190+G197 G140+G146 G160+G169 G170+G176; G210+G213			€ 806,00	€ 884,00
H60+H61 H120+H127			€ 741,00	€ 819,00

For fabrics see page 325
Per i tessuti si veda a p. 325

PACKING / Imballo



TECHNICAL DETAILS / Dettagli tecnici



Queen 650



SEAT Sedile	BACK Schienale	FRAME Telaio	POLYCARBONATE Policarbonato
PC	PC	PC	€ 123,00

PC FINISHES / Finiture PC



PACKING / Imballo



TECHNICAL DETAILS / Dettagli tecnici

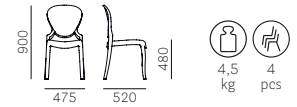

SAFETY, STRENGTH and DURABILITY TESTS
Prove di sicurezza, resistenza e durata
EN 1728:2000

Queen 650/CL1

Fire retardant version
Versione ignifuga



SEAT Sedile	BACK Schienale	FRAME Telaio	POLYCARBONATE Policarbonato
PC	PC	PC	€ 136,00

PC FINISHES / Finiture PC



PACKING / Imballo



TECHNICAL DETAILS / Dettagli tecnici

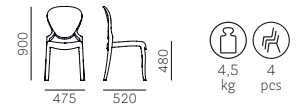

SAFETY, STRENGTH and DURABILITY TESTS
Prove di sicurezza, resistenza e durata
EN 1728:2000

Queen 650.3

Cushion only
Solo cuscino



SEAT Sedile	FABRIC Tessuto
C36+C39 fabric / tessuto	€ 137,00
E velvet / velluto	€ 189,00
G07 fabric / tessuto	€ 176,00
H40+H53 velvet / velluto	€ 133,00

For fabrics see page 325
Per i tessuti si veda a p. 325

PACKING / Imballo



TECHNICAL DETAILS / Dettagli tecnici

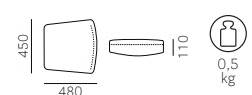

Queen 650.8

Fabric covering only
Solo vestina



SEAT Sedile	BACK Schienale	FRAME Telaio	FABRIC Tessuto
A10	A10	A10	€ 223,00

COVERING FINISHES / Finiture vestina



A10

RIM FINISHES / Finiture bordino



A10

PACKING / Imballo



MC 0,056

TECHNICAL DETAILS / Dettagli tecnici

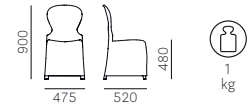

Remind 3730RM



recycled polypropylene



SEAT Sedile	BACK Schienale	FRAME Telaio	POLYPROPYLENE Polipropilene
PPL	PPL	PPL	€ 98,00

PPL FINISHES / Finiture PPL



RG

PACKING / Imballo



MC 0,335

TECHNICAL DETAILS / Dettagli tecnici



SAFETY, STRENGTH and DURABILITY TESTS
Prove di sicurezza, resistenza e durata
EN 1728:2012+AC2013
EN 16139:2013 level 2



Remind 3730



SEAT Sedile	BACK Schienale	FRAME Telaio	POLYPROPYLENE Polipropilene
PPL	PPL	PPL	€ 98,00

PPL FINISHES / Finiture PPL

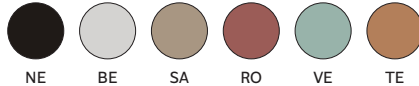

NE

BE

SA

RO

VE

TE

PACKING / Imballo



MC 0,335

TECHNICAL DETAILS / Dettagli tecnici



SAFETY, STRENGTH and DURABILITY TESTS
Prove di sicurezza, resistenza e durata
EN 1728:2012+AC2013
EN 16139:2013 level 2



Remind 3735RM



SEAT Sedile	BACK Schienale	FRAME Telaio	POLYPROPYLENE Polipropilene
PPL	PPL	PPL	€ 119,00

PPL FINISHES / Finiture PPL



PACKING / Imballo



TECHNICAL DETAILS / Dettagli tecnici

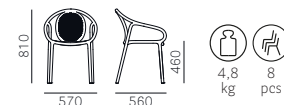

SAFETY, STRENGTH and DURABILITY TESTS
 Prove di sicurezza, resistenza e durata
 EN 1728:2012+AC2013
 EN 16139:2013 level 2
 ANSI-BIFMA X5.1-2017



Remind 3735



SEAT Sedile	BACK Schienale	FRAME Telaio	POLYPROPYLENE Polipropilene
PPL	PPL	PPL	€ 119,00

PPL FINISHES / Finiture PPL

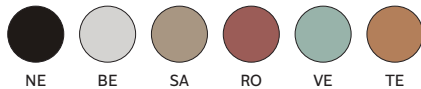

PACKING / Imballo



TECHNICAL DETAILS / Dettagli tecnici

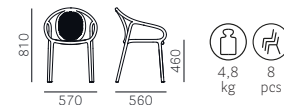

SAFETY, STRENGTH and DURABILITY TESTS
 Prove di sicurezza, resistenza e durata
 EN 1728:2012+AC2013
 EN 16139:2013 level 2
 ANSI-BIFMA X5.1-2017



Remind pixel



SEAT Sedile	BACK Schienale	FRAME Telaio	POLYPROPYLENE Polipropilene
PPL	PPL	PPL	€ 115,00 Pack of 300 pixels Confezione da 300 pixel

PPL FINISHES / Finiture PPL





CODE Codice	SEAT Sedile	BACK Schienale	FRAME Telaio	POWDER COATED Verniciato
RAIL Sun lounger Lettino	TXT	TXT	BI100E, SA200E + TXT	€ 956,00
RAIL + RAIL.23				€ 1.437,00
RAIL/2 Sun lounger with rear castors Lettino con ruote posteriori	TXT	TXT	BI100E, SA200E + TXT	€ 1.079,00
RAIL/2 + RAIL.23				€ 1.560,00
RAIL.23 Cushion for sun lounger Cuscino per lettino	D22+D26 D80+D89 D100+D105 D110+D114 D130	D22+D26 D80+D89 D100+D105 D110+D114 D130		€ 481,00
RAIL.30 Sun lounger roof Tettuccio parasole			BI100E, SA200E + TXT	€ 206,00

TXT FINISHES / Finiture TXT

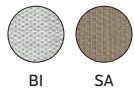

BI SA

POWDER COATED FINISHES / Finiture verniciato



BI100E SA200E

For fabrics see page 325
Per i tessuti si veda a p. 325

SAFETY, STRENGTH and DURABILITY TESTS
Prove di sicurezza, resistenza e durata
EN 1728:2012+AC2013
EN 581-2:2015

TECHNICAL DETAILS / Dettagli tecnici

RAIL



RAIL/2



RAIL.23

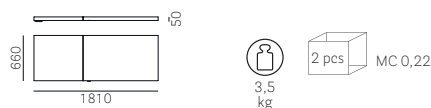

RAIL.30





CODE Codice	SEAT Sedile	BACK Schienale	FRAME Telaio	POWDER COATED Verniciato	FABRIC Tessuto
REVA_D Three seater sofa Divano a tre posti	D22÷D26 D80÷D89 D100÷D105 D110÷D114 D130	D22÷D26 D80÷D89 D100÷D105 D110÷D114 D130	BI100E, SA200E + TXT	€ 2.611,00	
REVA_D + 3005 (2pcs)				€ 2.807,00	
REVA_P Armchair Poltrona	D22÷D26 D80÷D89 D100÷D105 D110÷D114 D130	D22÷D26 D80÷D89 D100÷D105 D110÷D114 D130	BI100E, SA200E + TXT	€ 1.583,00	
REVA_P + 3005 (2pcs)				€ 1.779,00	
3005 Optional side pillow Cuscino laterale opzionale	D22÷D26 D80÷D89 D100÷D105 D110÷D114 D130	D22÷D26 D80÷D89 D100÷D105 D110÷D114 D130			€ 98,00 (1 pc / 1 pz)
3005.1 Pillowcase for lateral cushion Federa cuscino laterale	D22÷D26 D80÷D89 D100÷D105 D110÷D114 D130	D22÷D26 D80÷D89 D100÷D105 D110÷D114 D130			€ 62,00 (1 pc / 1 pz)
REVA.17 Pillowcase for seat cushion Federa cuscino sedile	D22÷D26 D80÷D89 D100÷D105 D110÷D114 D130				€ 194,00 (1 pc / 1 pz)
REVA.18 Pillowcase for backrest cushion Federa cuscino schienale		D22÷D26 D80÷D89 D100÷D105 D110÷D114 D130			€ 134,00 (1 pc / 1 pz)
REVA_L Sun lounger Lettino			BI100E, SA200E + TXT	€ 1.502,00	
REVA_L + REVA_L.3				€ 2.089,00	
REVA_L.3* Cushion for sun lounger Cuscino per lettino	D22÷D26 D80÷D89 D100÷D105 D110÷D114 D130	D22÷D26 D80÷D89 D100÷D105 D110÷D114 D130			€ 587,00
RAIL.30 Sun lounger roof Tettuccio parasole			BI100E, SA200E + TXT	€ 206,00	

*In case of combination with the sun lounger roof (item RAIL.30) supply the RAIL sun lounger cushion (item RAIL.23)
In caso di abbinamento con il tettuccio parasole (art. RAIL.30) fornire il cuscino per lettino del RAIL (art. RAIL.23)

Optional cushions available on request see page 312
Disponibili a richiesta i cuscini accessori si veda a p. 312

Optional protective covers available on request see page 314
Disponibili a richiesta le coperture protettive accessorie si veda a p. 314

TXT FINISHES (sofa and armchair)
Finiture TXT (divano e poltrona)

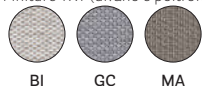

POWDER COATED FINISHES
Finiture verniciato



TXT FINISHES (sun lounger)
Finiture TXT (lettino)

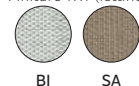

For fabrics see page 325
Per i tessuti si veda a p. 325

SAFETY, STRENGTH and DURABILITY TESTS

Prove di sicurezza, resistenza e durata
EN 1728:2012+AC2013
EN 16139:2013 level 2
(for REVA_L)
EN 1728:2012+AC2013
EN 581-1:2017
EN 581-2:2015+AC2013
(for REVA_D)

TECHNICAL DETAILS / Dettagli tecnici
REVA_D

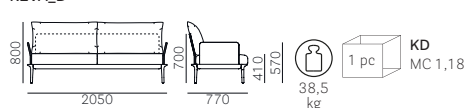

REVA_P

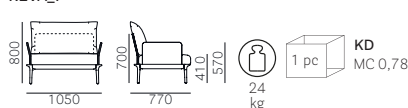

3005

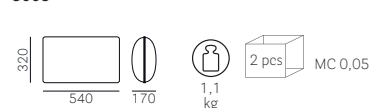

REVA_L

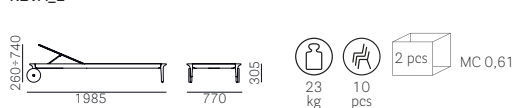

REVA_L.3

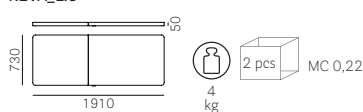

RAIL.30





CODE Codice	SEAT Sedile	BACK Schienale	FRAME Telaio	POWDER COATED Verniciato	FABRIC Tessuto
REVA/2_D Three seater sofa Divano a tre posti	D22+D26 D80+D89 D100+D105 D110+D114 D130	D22+D26 D80+D89 D100+D105 D110+D114 D130	Powder coated / Verniciato + Cord / Corda	€ 2.990,00	
REVA/2_D + 3005 (2pcs)				€ 3.186,00	
REVA/2_P Armchair Poltrona	D22+D26 D80+D89 D100+D105 D110+D114 D130	D22+D26 D80+D89 D100+D105 D110+D114 D130	Powder coated / Verniciato + Cord / Corda	€ 1.950,00	
REVA/2_P + 3005 (2pcs)				€ 2.146,00	
3005 Optional side pillow Cuscino laterale opzionale	D22+D26 D80+D89 D100+D105 D110+D114 D130	D22+D26 D80+D89 D100+D105 D110+D114 D130			€ 98,00 (1 pc / 1pz)
3005.1 Pillowcase for lateral cushion Federa cuscino laterale	D22+D26 D80+D89 D100+D105 D110+D114 D130	D22+D26 D80+D89 D100+D105 D110+D114 D130			€ 62,00 (1 pc / 1pz)
REVA.17 Pillowcase for seat cushion Federa cuscino sedile	D22+D26 D80+D89 D100+D105 D110+D114 D130				€ 194,00 (1 pc / 1pz)
REVA.18 Pillowcase for backrest cushion Federa cuscino schienale		D22+D26 D80+D89 D100+D105 D110+D114 D130			€ 134,00 (1 pc / 1pz)

Optional cushions available on request see page 312
Disponibili a richiesta i cuscini accessori si veda a p. 312

Optional protective covers available on request see page 314
Disponibili a richiesta le coperture protettive accessorie si veda a p. 314

CORD FINISHES

Finiture corda



BE MA2 TE

POWDER COATED FINISHES

Finiture verniciato



BI100E BE100E SA200E MGE TEE

TECHNICAL DETAILS / Dettagli tecnici

REVA/2_D

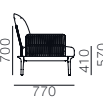
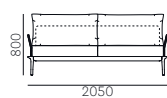

1 pc KD MC 1,18

41,5 kg

For fabrics see page 325

Per i tessuti si veda a p. 325

SAFETY, STRENGTH and DURABILITY TESTS

Prove di sicurezza, resistenza e durata

EN 1728:2012+AC2013

EN 581-1:2017

EN 581-2:2015+AC2013

(for REVA/2_D)

REVA/2_P

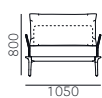

1 pc KD MC 0,76

26,5 kg

3005



2 pcs MC 0,05

1,1 kg

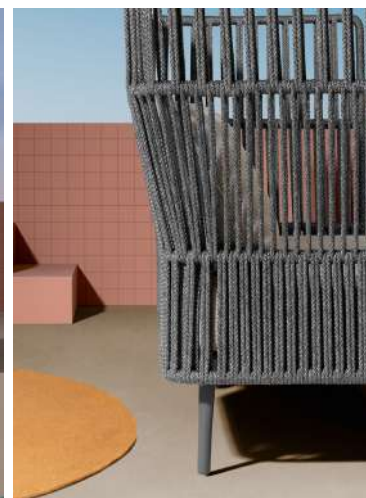

CODE Codice	SEAT Sedile	BACK Schienale	FRAME Telaio	POWDER COATED Verniciato
RVC010 Pouf	D22+D26 D80+D89 D100+D105 D110+D114 D130	D22+D26 D80+D89 D100+D105 D110+D114 D130	Powder coated / Verniciato	€ 1.736,00
RVC011 Linear armchair with high backrest Poltrona lineare con schienale alto	D22+D26 D80+D89 D100+D105 D110+D114 D130	D22+D26 D80+D89 D100+D105 D110+D114 D130	Powder coated / Verniciato + Cord / Corda	€ 2.678,00
RVC012 Linear armchair with low backrest Poltrona lineare con schienale basso				€ 2.314,00
RVC013 Right corner armchair Poltrona angolare DX	D22+D26 D80+D89 D100+D105 D110+D114 D130	D22+D26 D80+D89 D100+D105 D110+D114 D130	Powder coated / Verniciato + Cord / Corda	€ 4.076,00
RVC014 Left corner armchair Poltrona angolare SX				
RVC021 Linear sofa with high backrest Divano lineare con schienale alto	D22+D26 D80+D89 D100+D105 D110+D114 D130	D22+D26 D80+D89 D100+D105 D110+D114 D130	Powder coated / Verniciato + Cord / Corda	€ 5.415,00
RVC022 Linear sofa with low backrest Divano lineare con schienale basso				€ 4.687,00
RVC023 Right corner and linear sofa with high backrest Divano angolare DX e lineare con schienale alto	D22+D26 D80+D89 D100+D105 D110+D114 D130	D22+D26 D80+D89 D100+D105 D110+D114 D130	Powder coated / Verniciato + Cord / Corda	€ 6.552,00
RVC024 Left corner and linear sofa with high backrest Divano angolare SX e lineare con schienale alto				
RVC025 Right corner and linear sofa with low backrest Divano angolare DX e lineare con schienale basso	D22+D26 D80+D89 D100+D105 D110+D114 D130	D22+D26 D80+D89 D100+D105 D110+D114 D130	Powder coated / Verniciato + Cord / Corda	€ 6.188,00
RVC026 Left corner and linear sofa with low backrest Divano angolare SX e lineare con schienale basso				
RVC027 Right and left corner sofa Divano angolare DX e SX	D22+D26 D80+D89 D100+D105 D110+D114 D130	D22+D26 D80+D89 D100+D105 D110+D114 D130	Powder coated / Verniciato + Cord / Corda	€ 7.690,00
RVC033 Right chaise longue Chaise longue angolare DX	D22+D26 D80+D89 D100+D105 D110+D114 D130	D22+D26 D80+D89 D100+D105 D110+D114 D130	Powder coated / Verniciato + Cord / Corda	€ 4.453,00
RVC034 Left chaise longue Chaise longue angolare SX				

Optional cushions available on request see page 312
Disponibili a richiesta i cuscini accessori si veda a p. 312

Optional protective covers available on request see page 314
Disponibili a richiesta le coperture protettive accessorie si veda a p. 314

CORD FINISHES Finiture corda



BE GA2 TE

POWDER COATED FINISHES Finiture verniciato

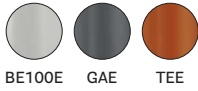

BE100E GAE TEE

For fabrics see page 325
Per i tessuti si veda a p. 325

TECHNICAL DETAILS / Dettagli tecnici RVC010



RVC011

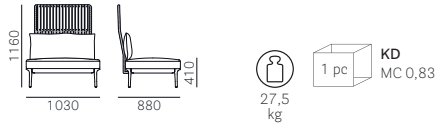

RVC012



RVC013

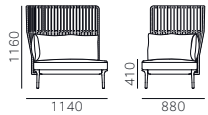

RVC014



RVC021

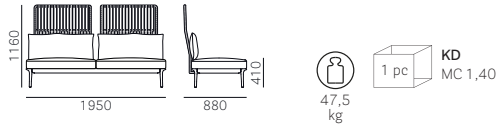

RVC022

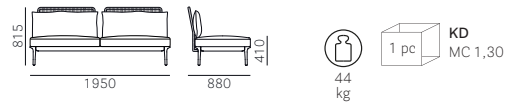

RVC023

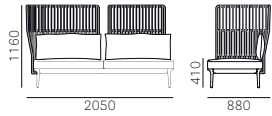

RVC024

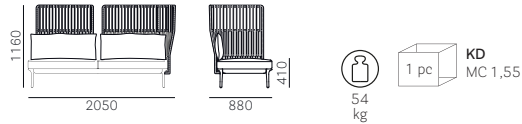

RVC025

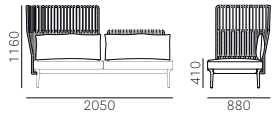

RVC026

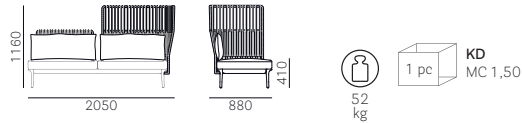

RVC027

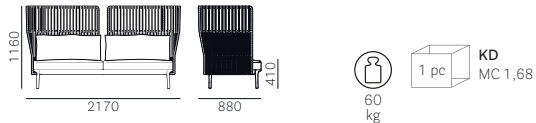

RVC033

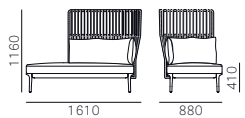

RVC034

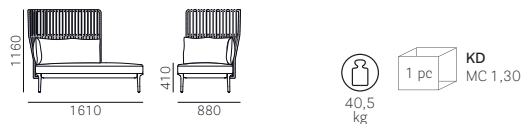

Rubik 580



SEAT Sedile	FRAME Telaio	POLYCARBONATE Policarbonato
PC	PC H750	€ 115,00

PC FINISHES / Finiture PC

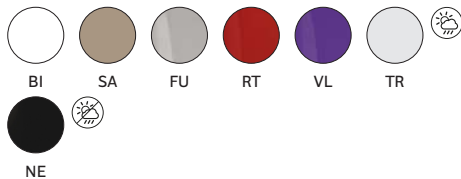

PACKING / Imballo



TECHNICAL DETAILS / Dettagli tecnici

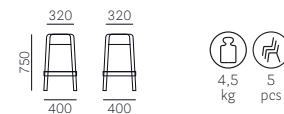

SAFETY, STRENGTH and DURABILITY TESTS
 Prove di sicurezza, resistenza e durata
 EN 15373:2007

Rubik 580/CL1

Fire retardant version
 Versione ignifuga



SEAT Sedile	FRAME Telaio	POLYCARBONATE Policarbonato
PC	PC H750	€ 133,00

Minimum order 300 pcs each colour
 Ordine minimo 300 pz per colore

PC FINISHES / Finiture PC

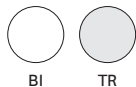

PACKING / Imballo



TECHNICAL DETAILS / Dettagli tecnici

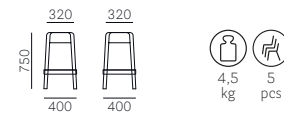

SAFETY, STRENGTH and DURABILITY TESTS
 Prove di sicurezza, resistenza e durata
 EN 15373:2007

Rubik 582



SEAT Sedile	FRAME Telaio	POLYCARBONATE Policarbonato
PC	PC H650	€ 142,00

PC FINISHES / Finiture PC

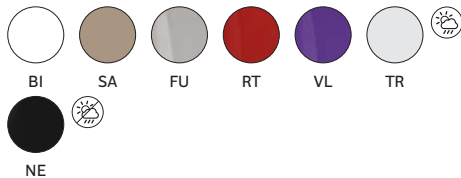

PACKING / Imballo



TECHNICAL DETAILS / Dettagli tecnici



SAFETY, STRENGTH and DURABILITY TESTS
 Prove di sicurezza, resistenza e durata
 EN 15373:2007

Rubik 583



SEAT Sedile	FRAME Telaio	POLYCARBONATE Policarbonato
PC	PC H450	€ 142,00

PC FINISHES / Finiture PC



PACKING / Imballo



TECHNICAL DETAILS / Dettagli tecnici



Serif 860



SEAT Sedile	FRAME Telaio	POLYETHYLENE Polietilene
PET	PET H750	€ 202,00

PET FINISHES / Finiture PET

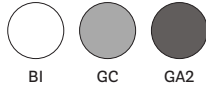

PACKING / Imballo



TECHNICAL DETAILS / Dettagli tecnici

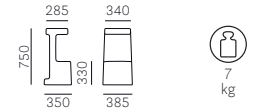

SAFETY, STRENGTH and DURABILITY TESTS
 Prove di sicurezza, resistenza e durata
 EN 1728:2000

Sign 455



SEAT Sedile	BACK Schienale	FRAME Telaio	OAK Rovere
C Excluding / Escluso C36+C39			€ 450,00
D120+D123			€ 478,00
G	RS-W-N1- GC-BI	RS-W-N1- GC-BI	€ 488,00
H			€ 455,00
P			€ 494,00

For fabrics see page 325
Per i tessuti si veda a p. 325

FINISHES / Finiture



PACKING / Imballo



TECHNICAL DETAILS / Dettagli tecnici

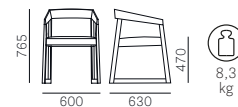

Sign 457



SEAT Sedile	BACK Schienale	FRAME Telaio	OAK Rovere
C Excluding / Escluso C36+C39	C		€ 615,00
D120+D123	D120+D123		€ 662,00
G	G	RS-W-N1- GC-BI	€ 696,00
H	H		€ 624,00
P	P		€ 718,00

For fabrics see page 325
Per i tessuti si veda a p. 325

FINISHES / Finiture



PACKING / Imballo



TECHNICAL DETAILS / Dettagli tecnici

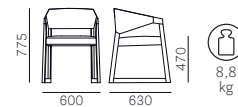

Snow 300



SEAT Sedile	BACK Schienale	FRAME Telaio	POLYPROPYLENE Polipropilene
PPL	PPL	PPL	€ 75,00

PPL FINISHES / Finiture PPL

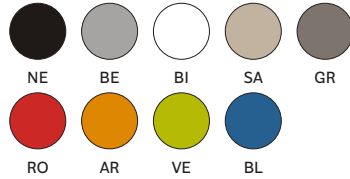

SAFETY, STRENGTH and DURABILITY TESTS
 Prove di sicurezza, resistenza e durata
 EN 1728:2000
 ANSI-BIFMA X5.1-2017

PACKING / Imballo



TECHNICAL DETAILS / Dettagli tecnici

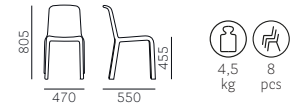

Snow 300/CL1

Fire retardant version
 Versione ignifuga



SEAT Sedile	BACK Schienale	FRAME Telaio	POLYPROPYLENE Polipropilene
PPL	PPL	PPL	€ 106,00

Minimum order 300 pcs
 Ordine minimo 300 pz

PPL FINISHES / Finiture PPL



SAFETY, STRENGTH and DURABILITY TESTS
 Prove di sicurezza, resistenza e durata
 EN 1728:2000
 ANSI-BIFMA X5.1-2017

PACKING / Imballo



TECHNICAL DETAILS / Dettagli tecnici

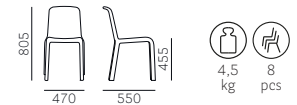

Snow 303

JUNIOR



SEAT Sedile	BACK Schienale	FRAME Telaio	POLYPROPYLENE Polipropilene
PPL	PPL	PPL	€ 63,00

PPL FINISHES / Finiture PPL



PACKING / Imballo



TECHNICAL DETAILS / Dettagli tecnici



Social

Two seats
Due sedute

SAFETY, STRENGTH and DURABILITY TESTS

Prove di sicurezza, resistenza e durata

EN 1728:2012+AC2013

EN 16139:2013 level 2

CODE Codice	SEAT Sedile	BACK Schienale	POWDER COATED Verniciato	POLISHED ALUMINIUM Alluminio lucidato
DSO_2L	C*	C*	€ 1.479,00	€ 1.515,00
	D40÷D44 D120÷D123	D40÷D44 D120÷D123	€ 1.589,00	€ 1.624,00
	E	E	€ 1.867,00	€ 1.904,00
	G	G	€ 1.757,00	€ 1.793,00
	H	H	€ 1.518,00	€ 1.554,00
	N*	N*	€ 1.836,00	€ 1.872,00
	P	P	€ 2.173,00	€ 2.208,00
DSO_2LP	C*	C*	€ 1.336,00	€ 1.373,00
	D40÷D44 D120÷D123	D40÷D44 D120÷D123	€ 1.437,00	€ 1.475,00
	E	E	€ 1.696,00	€ 1.731,00
	G	G	€ 1.592,00	€ 1.628,00
	H	H	€ 1.372,00	€ 1.408,00
	N*	N*	€ 1.663,00	€ 1.701,00
	P	P	€ 1.987,00	€ 2.023,00
DSO_2AL	C*	C*	€ 1.737,00	€ 1.772,00
	D40÷D44 D120÷D123	D40÷D44 D120÷D123	€ 1.874,00	€ 1.910,00
	E	E	€ 2.218,00	€ 2.253,00
	G	G	€ 2.065,00	€ 2.100,00
	H	H	€ 1.785,00	€ 1.822,00
	N*	N*	€ 2.183,00	€ 2.220,00
	P	P	€ 2.571,00	€ 2.608,00
DSO_2A	C*	C*	€ 1.996,00	€ 2.031,00
	D40÷D44 D120÷D123	D40÷D44 D120÷D123	€ 2.160,00	€ 2.196,00
	E	E	€ 2.567,00	€ 2.603,00
	G	G	€ 2.372,00	€ 2.408,00
	H	H	€ 2.053,00	€ 2.088,00
	N*	N*	€ 2.530,00	€ 2.567,00
	P	P	€ 2.970,00	€ 3.007,00
DSO_2P	C*	C*	€ 1.194,00	€ 1.232,00
	D40÷D44 D120÷D123	D40÷D44 D120÷D123	€ 1.285,00	€ 1.323,00
	E	E	€ 1.523,00	€ 1.559,00
	G	G	€ 1.427,00	€ 1.463,00
	H	H	€ 1.226,00	€ 1.263,00
	N*	N*	€ 1.492,00	€ 1.528,00
	P	P	€ 1.800,00	€ 1.836,00
DSO_LINK	Connecting plate kit for DSO sofas: surcharge € 32,00 Kit lamiera di collegamento per divani DSO: supplemento € 32,00			

* Excluding / Escluso C36+C39, N20+N27

For fabrics see page 325
Per i tessuti si veda a p. 325For colours and finishes see at page 320
Per colori e finiture vedere da pagina 320

TECHNICAL DETAILS / Dettagli tecnici

DSO_2L



DSO_2LP

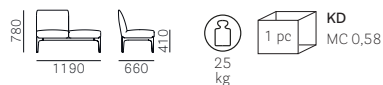

DSO_2AL



DSO_2A



DSO_2P



Social

Three seats
Tre sedute

SAFETY, STRENGTH and DURABILITY TESTS

Prove di sicurezza, resistenza e durata

EN 1728:2012+AC2013

EN 16139:2013 level 2

CODE Codice	SEAT Sedile	BACK Schienale	POWDER COATED Verniciato	POLISHED ALUMINIUM Alluminio lucidato
DSO_3L	C*	C*	€ 2.145,00	€ 2.183,00
	D40÷D44 D120÷D123	D40÷D44 D120÷D123	€ 2.311,00	€ 2.347,00
	E	E	€ 2.729,00	€ 2.766,00
	G	G	€ 2.563,00	€ 2.599,00
	H	H	€ 2.204,00	€ 2.240,00
	N*	N*	€ 2.681,00	€ 2.717,00
	P	P	€ 3.187,00	€ 3.222,00
DSO_3LLP	C*	C*	€ 2.002,00	€ 2.040,00
	D40÷D44 D120÷D123	D40÷D44 D120÷D123	€ 2.160,00	€ 2.195,00
	E	E	€ 2.558,00	€ 2.593,00
	G	G	€ 2.398,00	€ 2.434,00
	H	H	€ 2.058,00	€ 2.095,00
	N*	N*	€ 2.508,00	€ 2.546,00
	P	P	€ 3.000,00	€ 3.036,00
DSO_3ALL	C*	C*	€ 2.403,00	€ 2.439,00
	D40÷D44 D120÷D123	D40÷D44 D120÷D123	€ 2.597,00	€ 2.632,00
	E	E	€ 3.079,00	€ 3.115,00
	G	G	€ 2.871,00	€ 2.906,00
	H	H	€ 2.470,00	€ 2.507,00
	N*	N*	€ 3.028,00	€ 3.066,00
	P	P	€ 3.586,00	€ 3.622,00
DSO_3AAL	C*	C*	€ 2.662,00	€ 2.698,00
	D40÷D44 D120÷D123	D40÷D44 D120÷D123	€ 2.881,00	€ 2.918,00
	E	E	€ 3.430,00	€ 3.465,00
	G	G	€ 3.179,00	€ 3.214,00
	H	H	€ 2.738,00	€ 2.775,00
	N*	N*	€ 3.375,00	€ 3.413,00
	P	P	€ 3.984,00	€ 4.021,00
DSO_3ALP	C*	C*	€ 2.261,00	€ 2.298,00
	D40÷D44 D120÷D123	D40÷D44 D120÷D123	€ 2.444,00	€ 2.481,00
	E	E	€ 2.906,00	€ 2.942,00
	G	G	€ 2.706,00	€ 2.741,00
	H	H	€ 2.326,00	€ 2.361,00
	N*	N*	€ 2.857,00	€ 2.892,00
	P	P	€ 3.399,00	€ 3.435,00
DSO_LINK	Connecting plate kit for DSO sofas: surcharge € 32,00 Kit lamiera di collegamento per divani DSO: supplemento € 32,00			

* Excluding / Escluso C36+C39, N20+N27

For fabrics see page 325
Per i tessuti si veda a p. 325For colours and finishes see at page 320
Per colori e finiture vedere da pagina 320TECHNICAL DETAILS / Dettagli tecnici
DSO_3L

DSO_3LLP



DSO_3ALL

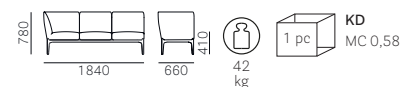

DSO_3AAL



DSO_3ALP



Social

Four seats
Quattro sedute

VAT NOT INCLUDED / Iva esclusa

Seating / Sedute



CODE Codice	SEAT Sedile	BACK Schienale	POWDER COATED Verniciato	POLISHED ALUMINIUM Alluminio lucidato	
DSO_4L	C*	C*	€ 2.864,00	€ 2.902,00	
	D40÷D44 D120÷D123	D40÷D44 D120÷D123	€ 3.084,00	€ 3.122,00	
	E	E	€ 3.642,00	€ 3.679,00	
	G	G	€ 3.421,00	€ 3.458,00	
	H	H	€ 2.941,00	€ 2.977,00	
	N*	N*	€ 3.579,00	€ 3.616,00	
DSO_4ALLL	P	P	€ 4.250,00	€ 4.288,00	
	C*	C*	€ 3.123,00	€ 3.159,00	
	D40÷D44 D120÷D123	D40÷D44 D120÷D123	€ 3.369,00	€ 3.406,00	
	E	E	€ 3.993,00	€ 4.030,00	
	G	G	€ 3.729,00	€ 3.764,00	
	H	H	€ 3.209,00	€ 3.247,00	
DSO_4AALL	N*	N*	€ 3.926,00	€ 3.963,00	
	P	P	€ 4.651,00	€ 4.688,00	
	C*	C*	€ 3.382,00	€ 3.417,00	
	D40÷D44 D120÷D123	D40÷D44 D120÷D123	€ 3.655,00	€ 3.692,00	
	E	E	€ 4.342,00	€ 4.380,00	
	G	G	€ 4.036,00	€ 4.072,00	
DSO_2X2P	H	H	€ 3.475,00	€ 3.513,00	
	N*	N*	€ 4.272,00	€ 4.309,00	
	P	P	€ 5.050,00	€ 5.086,00	
	C*	C*	€ 2.204,00	€ 2.240,00	
	D40÷D44 D120÷D123	D40÷D44 D120÷D123	€ 2.386,00	€ 2.424,00	
	E	E	€ 2.860,00	€ 2.898,00	
DSO_2X2P	G	G	€ 2.667,00	€ 2.703,00	
	H	H	€ 2.266,00	€ 2.304,00	
	N*	N*	€ 2.798,00	€ 2.834,00	
	P	P	€ 3.416,00	€ 3.452,00	
	DSO_LINK			Connecting plate kit for DSO sofas: surcharge € 32,00 Kit lamiera di collegamento per divani DSO: supplemento € 32,00	

* Excluding / Escluso C36+C39, N20+N27

For fabrics see page 325
Per i tessuti si veda a p. 325

For colours and finishes see at page 320
Per colori e finiture vedere da pagina 320

SAFETY, STRENGTH and DURABILITY TESTS

Prove di sicurezza, resistenza e durata
EN 1728:2012+AC2013
EN 16139:2013 level 2

TECHNICAL DETAILS / Dettagli tecnici

DSO_4L



DSO_4ALLL



DSO_4AALL



DSO_2X2P



Social corner 45° - 60° - 90° / tablet

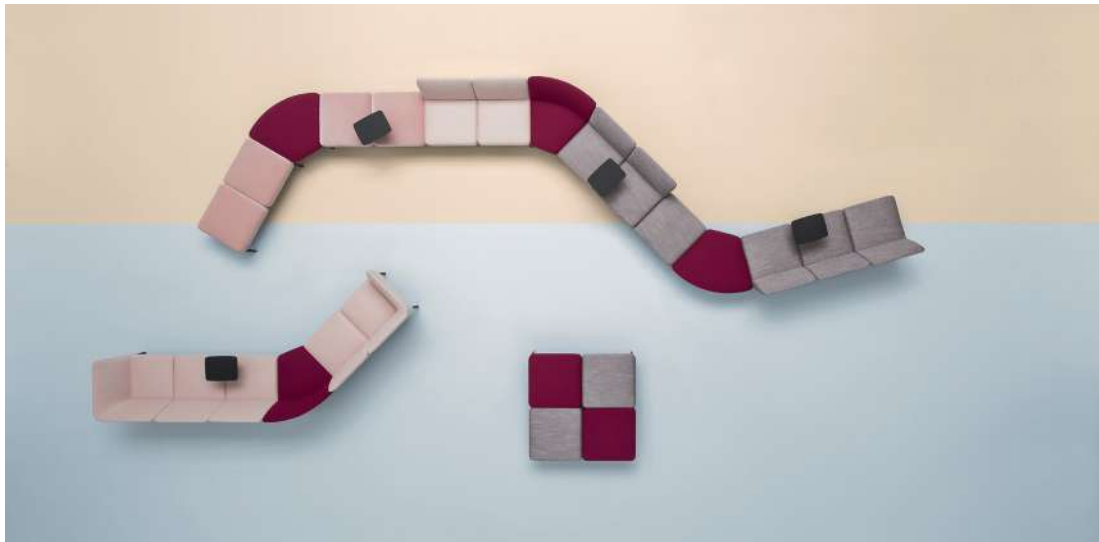

CODE Codice	SEAT Sedile	BACK Schienale	FABRIC Tessuto	POWDER COATED Verniciato	POLISHED ALUMINIUM Alluminio lucidato	TOP Ripiano
DSO45C Corner 45° with backrest Angolo 45° con schienale	C*	C*	€ 947,00			
	D40+D44 D120+D123	D40+D44 D120+D123	€ 1.020,00			
	E	E	€ 1.193,00			
	G	G	€ 1.129,00			
	H	H	€ 973,00			
	N*	N*	€ 1.182,00			
P	P	€ 1.277,00				
DSO60P Corner 60° without backrest Angolo 60° senza schienale	C*		€ 730,00			
	D40+D44 D120+D123		€ 806,00			
	E		€ 972,00			
	G		€ 923,00			
	H		€ 757,00			
	N*		€ 979,00			
P		€ 926,00				
DSO90C Corner 90° with backrest Angolo 90° con schienale	C*	C*		€ 1.983,00	€ 2.043,00	
	D40+D44 D120+D123	D40+D44 D120+D123		€ 2.127,00	€ 2.188,00	
	E	E		€ 2.383,00	€ 2.443,00	
	G	G		€ 2.347,00	€ 2.407,00	
	H	H		€ 2.034,00	€ 2.095,00	
	N*	N*		€ 2.452,00	€ 2.512,00	
P	P		€ 2.643,00	€ 2.703,00		
DSO/TT Turning tablet Tavoletta girevole						<p>€ 197,00</p>  <p>CFP_BI FNP_NE*</p> <p>* Anti-fingerprint finish Finitura anti-impronta</p>

* Excluding / Escluso C36+C39, N20+N27

For fabrics see page 325
Per i tessuti si veda a p. 325

For colours and finishes see at page 320
Per colori e finiture vedere da pagina 320

SAFETY, STRENGTH and DURABILITY TESTS
Prove di sicurezza, resistenza e durata
EN 1728:2012+AC2013
EN 16139:2013 level 2

TECHNICAL DETAILS / Dettagli tecnici

DSO45C



KD
1 pc
MC 0,405

DSO60P



KD
1 pc
MC 0,295

DSO90C

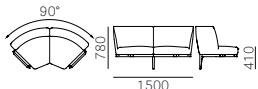

KD
1 pc
MC 0,77

DSO/TT

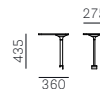

KD
1 pc
MC 0,022

Social Plus

Two seats
Due sedute

VAT NOT INCLUDED / Iva esclusa

Seating / Sedute



CODE Codice	SEAT Sedile	BACK Schienale	POWDER COATED Verniciato	POLISHED ALUMINIUM Alluminio lucidato	FABRIC Tessuto
DSO2_2L	C*	C*	€ 2.079,00	€ 2.173,00	
	D40÷D44 D120÷D123	D40÷D44 D120÷D123	€ 2.281,00	€ 2.373,00	
	E	E	€ 2.703,00	€ 2.797,00	
	G	G	€ 2.589,00	€ 2.681,00	
	H	H	€ 2.151,00	€ 2.243,00	
	N*	N*	€ 2.734,00	€ 2.828,00	
	P	P	€ 2.811,00	€ 2.903,00	
DSO2_2AL	C*	C*	€ 2.269,00	€ 2.364,00	
	D40÷D44 D120÷D123	D40÷D44 D120÷D123	€ 2.465,00	€ 2.559,00	
	E	E	€ 2.906,00	€ 3.000,00	
	G	G	€ 2.767,00	€ 2.860,00	
	H	H	€ 2.338,00	€ 2.430,00	
	N*	N*	€ 2.909,00	€ 3.002,00	
	P	P	€ 3.130,00	€ 3.222,00	
DSO2_2A	C*	C*	€ 2.460,00	€ 2.552,00	
	D40÷D44 D120÷D123	D40÷D44 D120÷D123	€ 2.651,00	€ 2.745,00	
	E	E	€ 3.111,00	€ 3.204,00	
	G	G	€ 2.946,00	€ 3.039,00	
	H	H	€ 2.525,00	€ 2.620,00	
	N*	N*	€ 3.084,00	€ 3.176,00	
	P	P	€ 3.447,00	€ 3.540,00	
 DSO2.3 Cushion only Solo cuscino	C	C			€ 99,00
	D40÷D44 D120÷D123	D40÷D44 D120÷D123			€ 117,00
	E	E			€ 143,00
	G	G			€ 143,00
	H	H			€ 104,00
	N*	N*			€ 158,00
	P	P			€ 203,00
DSO_LINK	Connecting plate kit for DSO2 sofas: surcharge € 32,00 Kit lamiera di collegamento per divani DSO2: supplemento € 32,00				

* Excluding / Escluso C36+C39, N20+N27

For fabrics see page 325
Per i tessuti si veda a p. 325

For colours and finishes see at page 320
Per colori e finiture vedere da pagina 320

SAFETY, STRENGTH and DURABILITY TESTS
Prove di sicurezza, resistenza e durata
EN 1728:2012+AC2013
EN 16139:2013 level 2

TECHNICAL DETAILS / Dettagli tecnici

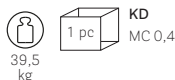
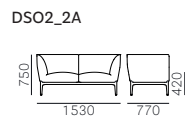
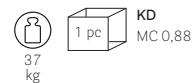
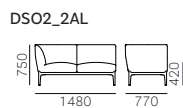
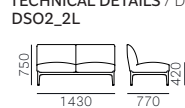

Social Plus

Three seats
Tre sedute

VAT NOT INCLUDED / Iva esclusa

Seating / Sedute



CODE Codice	SEAT Sedile	BACK Schienale	POWDER COATED Verniciato	POLISHED ALUMINIUM Alluminio lucidato	FABRIC Tessuto
DSO2_3L	C*	C*	€ 3.018,00	€ 3.120,00	
	D40÷D44 D120÷D123	D40÷D44 D120÷D123	€ 3.319,00	€ 3.421,00	
	E	E	€ 3.956,00	€ 4.058,00	
	G	G	€ 3.782,00	€ 3.882,00	
	H	H	€ 3.123,00	€ 3.226,00	
	N*	N*	€ 3.999,00	€ 4.101,00	
	P	P	€ 4.115,00	€ 4.216,00	
DSO2_3ALL	C*	C*	€ 3.209,00	€ 3.309,00	
	D40÷D44 D120÷D123	D40÷D44 D120÷D123	€ 3.505,00	€ 3.607,00	
	E	E	€ 4.159,00	€ 4.259,00	
	G	G	€ 3.962,00	€ 4.062,00	
	H	H	€ 3.312,00	€ 3.413,00	
	N*	N*	€ 4.175,00	€ 4.276,00	
	P	P	€ 4.433,00	€ 4.535,00	
DSO2_3AAL	C*	C*	€ 3.397,00	€ 3.499,00	
	D40÷D44 D120÷D123	D40÷D44 D120÷D123	€ 3.691,00	€ 3.791,00	
	E	E	€ 4.363,00	€ 4.463,00	
	G	G	€ 4.140,00	€ 4.240,00	
	H	H	€ 3.500,00	€ 3.600,00	
	N*	N*	€ 4.350,00	€ 4.450,00	
	P	P	€ 4.752,00	€ 4.853,00	
 DSO2.3 Cushion only Solo cuscino	C	C			€ 99,00
	D40÷D44 D120÷D123	D40÷D44 D120÷D123			€ 117,00
	E	E			€ 143,00
	G	G			€ 143,00
	H	H			€ 104,00
	N*	N*			€ 158,00
	P	P			€ 203,00
DSO_LINK	Connecting plate kit for DSO2 sofas: surcharge € 32,00 Kit lamiera di collegamento per divani DSO2: supplemento € 32,00				

* Excluding / Escluso C36+C39, N20+N27

For fabrics see page 325
Per i tessuti si veda a p. 325

For colours and finishes see at page 320
Per colori e finiture vedere da pagina 320

SAFETY, STRENGTH and DURABILITY TESTS
Prove di sicurezza, resistenza e durata
EN 1728:2012+AC2013
EN 16139:2013 level 2

TECHNICAL DETAILS / Dettagli tecnici

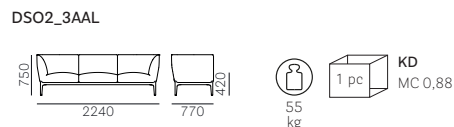
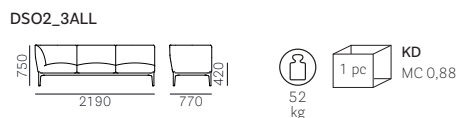
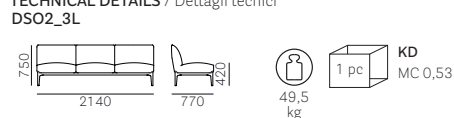

Social Plus

Four seats
Quattro sedute

CODE Codice	SEAT Sedile	BACK Schienale	POWDER COATED Verniciato	POLISHED ALUMINIUM Alluminio lucidato	FABRIC Tessuto
DSO2_4L	C*	C*	€ 4.050,00	€ 4.160,00	
	D40÷D44 D120÷D123	D40÷D44 D120÷D123	€ 4.452,00	€ 4.562,00	
	E	E	€ 5.299,00	€ 5.410,00	
	G	G	€ 5.069,00	€ 5.178,00	
	H	H	€ 4.190,00	€ 4.300,00	
	N*	N*	€ 5.359,00	€ 5.468,00	
	P	P	€ 5.514,00	€ 5.623,00	
DSO2_4ALL	C*	C*	€ 4.240,00	€ 4.350,00	
	D40÷D44 D120÷D123	D40÷D44 D120÷D123	€ 4.638,00	€ 4.748,00	
	E	E	€ 5.503,00	€ 5.613,00	
	G	G	€ 5.247,00	€ 5.358,00	
	H	H	€ 4.378,00	€ 4.488,00	
	N*	N*	€ 5.535,00	€ 5.644,00	
	P	P	€ 5.832,00	€ 5.941,00	
DSO2_4AALL	C*	C*	€ 4.430,00	€ 4.539,00	
	D40÷D44 D120÷D123	D40÷D44 D120÷D123	€ 4.823,00	€ 4.933,00	
	E	E	€ 5.705,00	€ 5.817,00	
	G	G	€ 5.425,00	€ 5.535,00	
	H	H	€ 4.566,00	€ 4.677,00	
	N*	N*	€ 5.709,00	€ 5.818,00	
	P	P	€ 6.149,00	€ 6.260,00	
 DSO2.3 Cushion only Solo cuscino	C	C			€ 99,00
	D40÷D44 D120÷D123	D40÷D44 D120÷D123			€ 117,00
	E	E			€ 143,00
	G	G			€ 143,00
	H	H			€ 104,00
	N*	N*			€ 158,00
	P	P			€ 203,00
DSO_LINK	Connecting plate kit for DSO2 sofas: surcharge € 32,00 Kit lamiera di collegamento per divani DSO2: supplemento € 32,00				

* Excluding / Escluso C36+C39, N20+N27

For fabrics see page 325
Per i tessuti si veda a p. 325For colours and finishes see at page 320
Per colori e finiture vedere da pagina 320

SAFETY, STRENGTH and DURABILITY TESTS

Prove di sicurezza, resistenza e durata
EN 1728:2012+AC2013
EN 16139:2013 level 2

TECHNICAL DETAILS / Dettagli tecnici

DSO2_4L



DSO2_4ALL

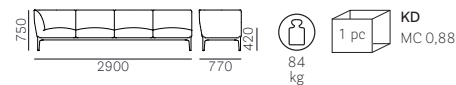

DSO2_4AALL



DSO2.3



Soul 3745



SEAT Sedile	BACK Schienale	FRAME Telaio	BLEACHED ASH Frassino sbiancato	BLACK LACQUERED ASH Frassino laccato nero	ASH STAINED WALNUT Frassino tinto noce
	FR	FR	€ 630,00 (TR, BI)		
PC	N2	N2			€ 630,00 (TR, BI, FU)
	AN	AN		€ 630,00 (NE, FU)	

PC FINISHES / Finiture PC

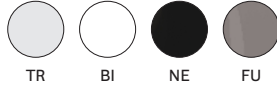

WOODEN FINISHES / Finiture legno



PACKING / Imballo



TECHNICAL DETAILS / Dettagli tecnici



SAFETY, STRENGTH and DURABILITY TESTS
 Prove di sicurezza, resistenza e durata
 EN 1728:2012+AC2013
 EN 16139:2013 level 2



Soul 3746

OUTDOOR



SEAT Sedile	BACK Schienale	FRAME Telaio	POWDER COATED Verniciato	ANODIZED ALUMINIUM Alluminio anodizzato
TEAK	METAL Ø 30	METAL Ø 30	€ 442,00	€ 532,00

FINISHES / Finiture



PACKING / Imballo



TECHNICAL DETAILS / Dettagli tecnici

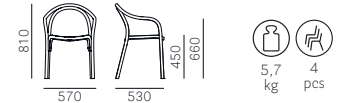

SAFETY, STRENGTH and DURABILITY TESTS
 Prove di sicurezza, resistenza e durata
 ANSI-BIFMA X5.1-2017

Soul 3747

SOFT



SEAT Sedile	BACK Schienale	FRAME Telaio	ASH Frassino
C110+C122 C210+C217			€ 810,00
H20+H35; H100+H108 H120+H127	FR - N2 AN	FR - N2 AN	€ 823,00
G Excluding / Escluso G100+G102, G180+G185, G230+G239			€ 899,00
P			€ 944,00

For fabrics see page 325
 Per i tessuti si veda a p. 325

FINISHES / Finiture



PACKING / Imballo



TECHNICAL DETAILS / Dettagli tecnici

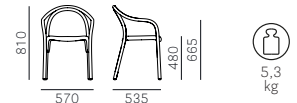

SAFETY, STRENGTH and DURABILITY TESTS
 Prove di sicurezza, resistenza e durata
 EN 1728:2012+AC2013
 EN 16139:2013 level 2



Souvenir 550R



recycled polypropylene.



SEAT Sedile	BACK Schienale	FRAME Telaio	POLYPROPYLENE Polipropilene
PPL	PPL	PPL	€ 98,00

PPL FINISHES / Finiture PPL



RG

PACKING / Imballo



MC 0,405

TECHNICAL DETAILS / Dettagli tecnici



SAFETY, STRENGTH and DURABILITY TESTS
Prove di sicurezza, resistenza e durata
EN 1728:2012+AC2013
EN 16139:2013 level 2

Souvenir 550



SEAT Sedile	BACK Schienale	FRAME Telaio	POLYPROPYLENE Polipropilene
PPL	PPL	PPL	€ 98,00

PPL FINISHES / Finiture PPL



BI

NE

GC

RA

RO

VE

PACKING / Imballo



MC 0,405

TECHNICAL DETAILS / Dettagli tecnici



SAFETY, STRENGTH and DURABILITY TESTS
Prove di sicurezza, resistenza e durata
EN 1728:2012+AC2013
EN 16139:2013 level 2

Souvenir 555R



recycled polypropylene.



SEAT Sedile	BACK Schienale	FRAME Telaio	POLYPROPYLENE Polipropilene
PPL	PPL	PPL	€ 119,00

PPL FINISHES / Finiture PPL



RG

PACKING / Imballo



MC 0,485

TECHNICAL DETAILS / Dettagli tecnici

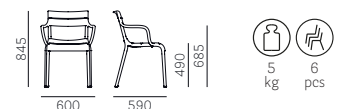

Souvenir 555



SEAT Sedile	BACK Schienale	FRAME Telaio	POLYPROPYLENE Polipropilene
PPL	PPL	PPL	€ 119,00

PPL FINISHES / Finiture PPL



PACKING / Imballo



TECHNICAL DETAILS / Dettagli tecnici

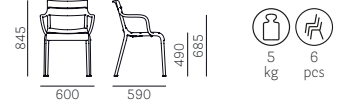

Sunset 625



SEAT Sedile	BACK Schienale	FRAME Telaio	POLYETHYLENE Polietilene
PET	PET	PET	€ 536,00

PET FINISHES / Finiture PET



PACKING / Imballo



TECHNICAL DETAILS / Dettagli tecnici

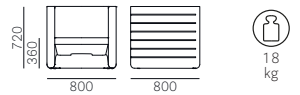

Sunset 625.10

Seat + back cushion
Cuscino per sedile e schienale



SEAT Sedile	BACK Schienale	FABRIC Tessuto
D22+D26 D80+D89 D100+D105 D110+D114 D130	D22+D26 D80+D89 D100+D105 D110+D114 D130	€ 422,00

We suggest to remove the cushions over night and in rainy days
Si consiglia di ritirare i cuscini durante la notte e in caso di pioggia

For fabrics see page 325
Per i tessuti si veda a p. 325

PACKING / Imballo



TECHNICAL DETAILS / Dettagli tecnici

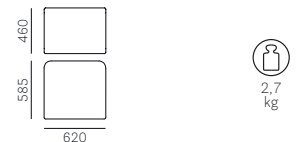

Sunset 625.3

Seat cushion
Cuscino per sedile

SEAT Sedile	FABRIC Tessuto
D22+D26 D80+D89 D100+D105 D110+D114 D130	€ 227,00

We suggest to remove the cushions over night and in rainy days
Si consiglia di ritirare i cuscini durante la notte e in caso di pioggia

For fabrics see page 325
Per i tessuti si veda a p. 325

PACKING / Imballo



TECHNICAL DETAILS / Dettagli tecnici

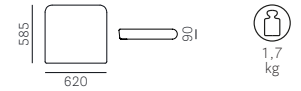

Sunset 626

SOFA



SEAT Sedile	BACK Schienale	FRAME Telaio	POLYETHYLENE Polietilene
PET	PET	PET	€ 947,00

PET FINISHES / Finiture PET



PACKING / Imballo



TECHNICAL DETAILS / Dettagli tecnici

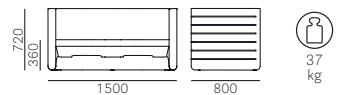

Sunset 626.10

Seat + back cushion
Cuscino per sedile e schienale

SEAT Sedile	BACK Schienale	FABRIC Tessuto
D22+D26 D80+D89 D100+D105 D110+D114 D130	D22+D26 D80+D89 D100+D105 D110+D114 D130	€ 692,00

We suggest to remove the cushions over night and in rainy days
Si consiglia di ritirare i cuscini durante la notte e in caso di pioggia

For fabrics see page 325
Per i tessuti si veda a p. 325

PACKING / Imballo



TECHNICAL DETAILS / Dettagli tecnici

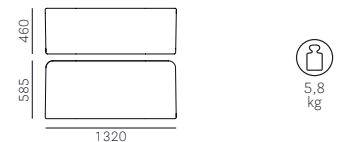

Sunset 626.3

Seat cushion
Cuscino per sedile



SEAT Sedile	FABRIC Tessuto
D22+D26 D80+D89 D100+D105 D110+D114 D130	€ 376,00

We suggest to remove the cushions over night and in rainy days
Si consiglia di ritirare i cuscini durante la notte e in caso di pioggia
For fabrics see page 325
Per i tessuti si veda a p. 325

PACKING / Imballo



TECHNICAL DETAILS / Dettagli tecnici

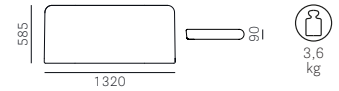

Sunset 625.20

Supporting HPL top
Piano d'appoggio



TOP Ripiano	FRAME Telaio	SOLID LAMINATE Stratificato
CFP_BI	BI100E	€ 110,00 For Sunset BI, SA
COP_234	BE200E	€ 110,00 For Sunset BE

FINISHES / Finiture

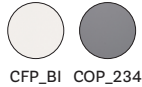

PACKING / Imballo



TECHNICAL DETAILS / Dettagli tecnici

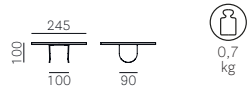

Sunset 625.30

Double supporting HPL top
Doppio piano d'appoggio



TOP Ripiano	FRAME Telaio	SOLID LAMINATE Stratificato
CFP_BI	BI100E	€ 112,00 For Sunset BI, SA
COP_234	BE200E	€ 112,00 For Sunset BE

FINISHES / Finiture



PACKING / Imballo



TECHNICAL DETAILS / Dettagli tecnici



Tatami 305



SEAT Sedile	BACK Schienale	FRAME Telaio	POLYPROPYLENE Polipropilene
PPL	PPL	PPL	€ 75,00

PPL FINISHES / Finiture PPL



PACKING / Imballo



TECHNICAL DETAILS / Dettagli tecnici



SAFETY, STRENGTH and DURABILITY TESTS
Prove di sicurezza, resistenza e durata
EN 1728:2000



Tatami 306



SEAT Sedile	BACK Schienale	FRAME Telaio	POLYPROPYLENE Polipropilene
PPL	PPL	PPL	€ 97,00

PPL FINISHES / Finiture PPL



PACKING / Imballo



TECHNICAL DETAILS / Dettagli tecnici



SAFETY, STRENGTH and DURABILITY TESTS
Prove di sicurezza, resistenza e durata
EN 1728:2000



Temps 3765



SEAT Sedile	BACK Schienale	FRAME Telaio	WHITE/BLACK POWDER COATED Verniciato bianco/nero	POLISHED ALUMINIUM Alluminio lucidato
C83+C89; C100+C101 C110+C122 C210+C217	C83+C89; C100+C101 C110+C122 C210+C217	Ø 750	€ 779,00	€ 858,00*
G59+G78; G190+G197 G140+G146 G160+G169 G170+G176; G210+G213	G59+G78; G190+G197 G140+G146 G160+G169 G170+G176; G210+G213		€ 910,00	€ 990,00*
H60+H61 H120+H127	H60+H61 H120+H127		€ 797,00	€ 877,00*

*Armrest finish: black only
Finitura bracciolo: solo nero

PPL FINISHES / Finiture PPL

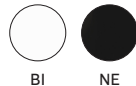

PACKING / Imballo



TECHNICAL DETAILS / Dettagli tecnici



SAFETY, STRENGTH and DURABILITY TESTS
Prove di sicurezza, resistenza e durata
EN 1728:2012+AC2013
EN 1335-2:2018
ANSI-BIFMA X5.1-2017

For fabrics see page 325
Per i tessuti si veda a p. 325

Temps 3766

LOW BACK



SEAT Sedile	BACK Schienale	FRAME Telaio	WHITE/BLACK POWDER COATED Verniciato bianco/nero	POLISHED ALUMINIUM Alluminio lucidato
C83+C89; C100+C101 C110+C122 C210+C217	C83+C89; C100+C101 C110+C122 C210+C217	Ø 750	€ 748,00	€ 827,00*
G59+G78; G190+G197 G140+G146 G160+G169 G170+G176; G210+G213	G59+G78; G190+G197 G140+G146 G160+G169 G170+G176; G210+G213		€ 879,00	€ 957,00*
H60+H61 H120+H127	H60+H61 H120+H127		€ 766,00	€ 844,00*

*Armrest finish: black only
Finitura bracciolo: solo nero

PPL FINISHES / Finiture PPL

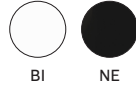

For fabrics see page 325
Per i tessuti si veda a p. 325

PACKING / Imballo



TECHNICAL DETAILS / Dettagli tecnici



SAFETY, STRENGTH and DURABILITY TESTS
Prove di sicurezza, resistenza e durata
EN 1728:2012+AC2013
EN 1335-2:2018
ANSI-BIFMA X5.1-2017

Tivoli 2800



SEAT Sedile	BACK Schienale	FRAME Telaio	ASH Frassino
FR-N1-GC- BI-AN	FR-N1-GC- BI-AN	FR-N1-GC- BI-AN	€ 539,00

FINISHES / Finiture

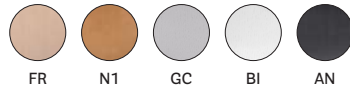

PACKING / Imballo



TECHNICAL DETAILS / Dettagli tecnici



SAFETY, STRENGTH and DURABILITY TESTS
Prove di sicurezza, resistenza e durata
EN 1728:2012+AC2013
EN 16139:2013 level 2

Tivoli 2800



SEAT Sedile	BACK Schienale	FRAME Telaio	ASH Frassino
BL2 AZ1 VE2 VE1 RB RA MO MC	BL2 AZ1 VE2 VE1 RB RA MO MC	BL2 AZ1 VE2 VE1 RB RA MO MC	€ 554,00 Lacquered with visible grains Laccato a poro aperto

FINISHES / Finiture

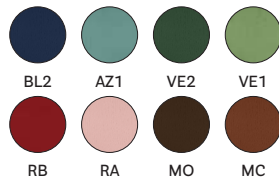

PACKING / Imballo



TECHNICAL DETAILS / Dettagli tecnici



SAFETY, STRENGTH and DURABILITY TESTS
Prove di sicurezza, resistenza e durata
EN 1728:2012+AC2013
EN 16139:2013 level 2



Tivoli 2801



SEAT Sedile	BACK Schienale	FRAME Telaio	ASH Frassino
C Excluding / Escluso C36+C39	C	FR-N1-GC- BI-AN	€ 645,00
G	G		€ 714,00
H Excluding / Escluso H140+H143	H		€ 650,00
P	P		€ 739,00

For fabrics see page 325
Per i tessuti si veda a p. 325

FINISHES / Finiture

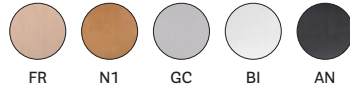

PACKING / Imballo



TECHNICAL DETAILS / Dettagli tecnici



SAFETY, STRENGTH and DURABILITY TESTS
Prove di sicurezza, resistenza e durata
EN 1728:2012+AC2013
EN 16139:2013 level 2



Tivoli 2802



SEAT Sedile	BACK Schienale	FRAME Telaio	ASH Frassino
C Excluding / Escluso C36+C39	C	FR-N1-GC- BI-AN	€ 592,00
G	G		€ 627,00
H Excluding / Escluso H140+H143	H		€ 595,00
P	P		€ 639,00

For fabrics see page 325
Per i tessuti si veda a p. 325

FINISHES / Finiture

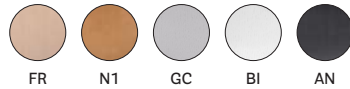

PACKING / Imballo



TECHNICAL DETAILS / Dettagli tecnici



SAFETY, STRENGTH and DURABILITY TESTS
Prove di sicurezza, resistenza e durata
EN 1728:2012+AC2013
EN 16139:2013 level 2



Tivoli 2805



SEAT Sedile	BACK Schienale	FRAME Telaio	ASH Frassino
FR-N1-GC- BI-AN	FR-N1-GC- BI-AN	FR-N1-GC- BI-AN	€ 621,00

FINISHES / Finiture



PACKING / Imballo



TECHNICAL DETAILS / Dettagli tecnici



SAFETY, STRENGTH and DURABILITY TESTS
Prove di sicurezza, resistenza e durata
EN 1728:2012+AC2013
EN 16139:2013 level 2



PRODUCT CERTIFIED
FOR LOW CHEMICAL
EMISSIONS:
UL.COM/GG
UL 2818

Tivoli 2805



SEAT Sedile	BACK Schienale	FRAME Telaio
BL2	BL2	BL2
AZ1	AZ1	AZ1
VE2	VE2	VE2
VE1	VE1	VE1
RB	RB	RB
RA	RA	RA
MO	MO	MO
MC	MC	MC

ASH
Frassino

€ 635,00
Lacquered with visible grains
Laccato a poro aperto

FINISHES / Finiture

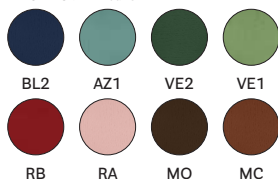

PACKING / Imballo



TECHNICAL DETAILS / Dettagli tecnici



SAFETY, STRENGTH and DURABILITY TESTS
Prove di sicurezza, resistenza e durata
EN 1728:2012+AC2013
EN 16139:2013 level 2

Tivoli 2806



SEAT Sedile	BACK Schienale	FRAME Telaio
C Excluding / Escluso C36+C39	C	
G	G	FR-N1-GC- BI-AN
H Excluding / Escluso H140+H143	H	
P	P	

ASH
Frassino

€ 745,00

€ 822,00

€ 751,00

€ 848,00

For fabrics see page 325
Per i tessuti si veda a p. 325

FINISHES / Finiture



PACKING / Imballo



TECHNICAL DETAILS / Dettagli tecnici



SAFETY, STRENGTH and DURABILITY TESTS
Prove di sicurezza, resistenza e durata
EN 1728:2012+AC2013
EN 16139:2013 level 2

Tivoli 2807



SEAT Sedile	BACK Schienale	FRAME Telaio
C Excluding / Escluso C36+C39	C	
G	FR-N1-GC- BI-AN	FR-N1-GC- BI-AN
H Excluding / Escluso H140+H143	H	
P	P	

ASH
Frassino

€ 683,00

€ 721,00

€ 687,00

€ 735,00

For fabrics see page 325
Per i tessuti si veda a p. 325

FINISHES / Finiture



PACKING / Imballo



TECHNICAL DETAILS / Dettagli tecnici



SAFETY, STRENGTH and DURABILITY TESTS
Prove di sicurezza, resistenza e durata
EN 1728:2012+AC2013
EN 16139:2013 level 2

Tribeca 3660



SEAT Sedile	BACK Schienale	FRAME Telaio	POWDER COATED Verniciato
PVC	PVC	METAL Ø 20	€ 281,00

*Flexible PVC profile in the same colour of the frame. Only for BI200 colour frame, PVC profile is in beige colour
Intreccio in PVC flessibile in tinta con il telaio. Solo per il colore del telaio BI200, l'intreccio in PVC è color beige

FINISHES / Finiture



PACKING / Imballo



TECHNICAL DETAILS / Dettagli tecnici



SAFETY, STRENGTH and DURABILITY TESTS
Prove di sicurezza, resistenza e durata
EN 1728:2012+AC2013
EN 16139:2013 level 2

Tribeca 3665



SEAT Sedile	BACK Schienale	FRAME Telaio	POWDER COATED Verniciato
PVC	PVC	METAL Ø 20	€ 309,00

*Flexible PVC profile in the same colour of the frame. Only for BI200 colour frame, PVC profile is in beige colour
Intreccio in PVC flessibile in tinta con il telaio. Solo per il colore del telaio BI200, l'intreccio in PVC è color beige

FINISHES / Finiture



PACKING / Imballo



TECHNICAL DETAILS / Dettagli tecnici



SAFETY, STRENGTH and DURABILITY TESTS
Prove di sicurezza, resistenza e durata
EN 1728:2012+AC2013
EN 16139:2013 level 2

Tribeca 3667



SEAT Sedile	BACK Schienale	FRAME Telaio	POWDER COATED Verniciato
PVC	PVC	METAL Ø 20 H675	€ 298,00

*Flexible PVC profile in the same colour of the frame. Only for BI200 colour frame, PVC profile is in beige colour
Intreccio in PVC flessibile in tinta con il telaio. Solo per il colore del telaio BI200, l'intreccio in PVC è color beige

FINISHES / Finiture



PACKING / Imballo



TECHNICAL DETAILS / Dettagli tecnici



SAFETY, STRENGTH and DURABILITY TESTS
Prove di sicurezza, resistenza e durata
EN 1728:2012+AC2013
EN 16139:2013 level 2

Tribeca 3668



SEAT Sedile	BACK Schienale	FRAME Telaio	POWDER COATED Verniciato
PVC	PVC	METAL Ø 20 H775	€ 307,00

*Flexible PVC profile in the same colour of the frame. Only for BI200 colour frame, PVC profile is in beige colour
Intreccio in PVC flessibile in tinta con il telaio. Solo per il colore del telaio BI200, l'intreccio in PVC è color beige

FINISHES / Finiture



PACKING / Imballo



TECHNICAL DETAILS / Dettagli tecnici

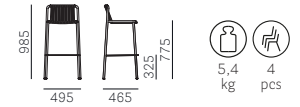

SAFETY, STRENGTH and DURABILITY TESTS
Prove di sicurezza, resistenza e durata
EN 1728:2012+AC2013
EN 16139:2013 level 2

Tribeca 3669

LOUNGE



SEAT Sedile	BACK Schienale	FRAME Telaio	POWDER COATED Verniciato
PVC	PVC	METAL Ø 20	€ 372,00

*Flexible PVC profile in the same colour of the frame. Only for BI200 colour frame, PVC profile is in beige colour
Intreccio in PVC flessibile in tinta con il telaio. Solo per il colore del telaio BI200, l'intreccio in PVC è color beige

FINISHES / Finiture



PACKING / Imballo



TECHNICAL DETAILS / Dettagli tecnici



Tribeca 3666

SOFA LOUNGE



SEAT Sedile	BACK Schienale	FRAME Telaio	POWDER COATED Verniciato
PVC	PVC	METAL Ø 20	€ 758,00

*Flexible PVC profile in the same colour of the frame. Only for BI200 colour frame, PVC profile is in beige colour
Intreccio in PVC flessibile in tinta con il telaio. Solo per il colore del telaio BI200, l'intreccio in PVC è color beige

FINISHES / Finiture



PACKING / Imballo



TECHNICAL DETAILS / Dettagli tecnici



Tweet 890

One-colour
Monocolore



SEAT Sedile	BACK Schienale	FRAME Telaio	POWDER COATED Verniciato	CHROMED Cromato	MATT CHROMED Cromato opaco
PPL	PPL	Ø 14	€ 124,00 AR frame finish excluded Escluso telaio finitura AR	€ 124,00	€ 150,00

Fire-retardant version available on request: surcharge **€ 33,00** (item 890/CL1) - Minimum order 300 pcs each colour
 Disponibile a richiesta la versione ignifuga: supplemento **€ 33,00** (art. 890/CL1) - Ordine minimo 300 pz per colore

PPL FINISHES / Finiture PPL



PACKING / Imballo



TECHNICAL DETAILS / Dettagli tecnici



SAFETY, STRENGTH and DURABILITY TESTS

Prove di sicurezza, resistenza e durata
 EN 1728:2012+AC2013
 EN 16139:2013 level 2



Tweet 890

Bicolour
Bicolore



SEAT Sedile	BACK Schienale	FRAME Telaio	POWDER COATED Verniciato	CHROMED Cromato	MATT CHROMED Cromato opaco
PPL	PPL	Ø 14	€ 124,00 GI frame finish excluded Escluso telaio finitura GI	€ 124,00	€ 150,00

Fire-retardant version available on request: surcharge **€ 33,00** (item 890/CL1) - Minimum order 300 pcs each colour
 Disponibile a richiesta la versione ignifuga: supplemento **€ 33,00** (art. 890/CL1) - Ordine minimo 300 pz per colore

White front side always
 Scocca interna sempre bianca

PPL FINISHES / Finiture PPL

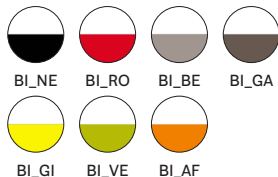

PACKING / Imballo



TECHNICAL DETAILS / Dettagli tecnici



SAFETY, STRENGTH and DURABILITY TESTS

Prove di sicurezza, resistenza e durata
 EN 1728:2012+AC2013
 EN 16139:2013 level 2



Tweet 894

One-colour
Monocolore



SEAT Sedile	BACK Schienale	FRAME Telaio	CHROMED Cromato
PPL	PPL	Ø 11	€ 160,00

Fire-retardant version available on request: surcharge **€ 33,00** (item 894/CL1) - Minimum order 300 pcs each colour
 Disponibile a richiesta la versione ignifuga: supplemento **€ 33,00** (art. 894/CL1) - Ordine minimo 300 pz per colore

PPL FINISHES / Finiture PPL

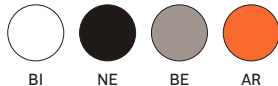

PACKING / Imballo



TECHNICAL DETAILS / Dettagli tecnici

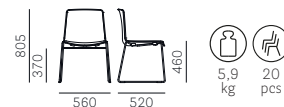

For colours and finishes see at page 320
 Per colori e finiture vedere da pagina 320

Tweet 894

Bicolour
Bicolore



SEAT Sedile	BACK Schienale	FRAME Telaio	CHROMED Cromato
PPL	PPL	Ø 11	€ 160,00

Fire-retardant version available on request: surcharge **€ 33,00** (item 894/CL1) - Minimum order 300 pcs each colour
Disponibile a richiesta la versione ignifuga: supplemento **€ 33,00** (art. 894/CL1) - Ordine minimo 300 pz per colore

White front side always
Scocca interna sempre bianca

PPL FINISHES / Finiture PPL

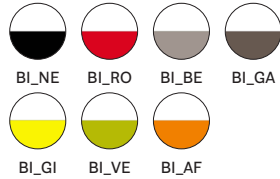

PACKING / Imballo



TECHNICAL DETAILS / Dettagli tecnici

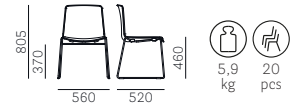

Tweet 894/TT

Turning tablet only
Solo tavoletta girevole



TOP Ripiano

€ 123,00
Chromed armrest Ø11 mm
Bracciolo in tondino Ø11 mm cromato

For item / Per articoli
894, 894/2

TABLET FINISH / Finitura tavoletta



PACKING / Imballo



TECHNICAL DETAILS / Dettagli tecnici



Tweet 897

One-colour
Monocolore



SEAT Sedile	BACK Schienale	FRAME Telaio	POWDER COATED Verniciato	CHROMED Cromato
PPL	PPL	Ø 11	€ 138,00 AR frame finish excluded Escluso telaio finitura AR	€ 138,00

Fire-retardant version available on request: surcharge **€ 33,00** (item 897/CL1) - Minimum order 300 pcs each colour
Disponibile a richiesta la versione ignifuga: supplemento **€ 33,00** (art. 897/CL1) - Ordine minimo 300 pz per colore

PPL FINISHES / Finiture PPL

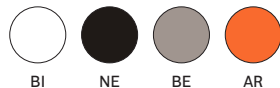

PACKING / Imballo



TECHNICAL DETAILS / Dettagli tecnici



SAFETY, STRENGTH and DURABILITY TESTS
Prove di sicurezza, resistenza e durata
EN 1728:2012+AC2013
EN 16139:2013 level 2

For colours and finishes see at page 320
Per colori e finiture vedere da pagina 320



Tweet 897

Bicolour
Bicolore



SEAT Sedile	BACK Schienale	FRAME Telaio	POWDER COATED Verniciato	CHROMED Cromato
PPL	PPL	Ø 11	<p>€ 138,00 GI frame finish excluded Escluso telaio finitura GI</p>	<p>€ 138,00</p>

Fire-retardant version available on request: surcharge **€ 33,00** (item 897/CL1) - Minimum order 300 pcs each colour
Disponibile a richiesta la versione ignifuga: supplemento **€ 33,00** (art. 897/CL1) - Ordine minimo 300 pz per colore

White front side always
Scocca interna sempre bianca

PPL FINISHES / Finiture PPL

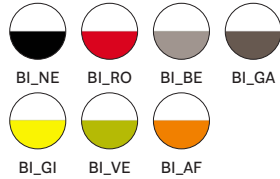

SAFETY, STRENGTH and DURABILITY TESTS
Prove di sicurezza, resistenza e durata
EN 1728:2012+AC2013
EN 16139:2013 level 2

PACKING / Imballo



TECHNICAL DETAILS / Dettagli tecnici



Tweet 893

One-colour
Monocolore



SEAT Sedile	BACK Schienale	FRAME Telaio	BLACK POWDER COATED Verniciato nero
PPL	PPL	Ø 680	<p>€ 244,00</p>

Fire-retardant version available on request: surcharge **€ 33,00** (item 893/CL1) - Minimum order 300 pcs each colour
Disponibile a richiesta la versione ignifuga: supplemento **€ 33,00** (art. 893/CL1) - Ordine minimo 300 pz per colore

PPL FINISHES / Finiture PPL

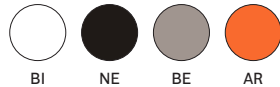

PACKING / Imballo



TECHNICAL DETAILS / Dettagli tecnici



Tweet 893

Bicolour
Bicolore



SEAT Sedile	BACK Schienale	FRAME Telaio	BLACK POWDER COATED Verniciato nero
PPL	PPL	Ø 680	<p>€ 244,00</p>

Fire-retardant version available on request: surcharge **€ 33,00** (item 893/CL1) - Minimum order 300 pcs each colour
Disponibile a richiesta la versione ignifuga: supplemento **€ 33,00** (art. 893/CL1) - Ordine minimo 300 pz per colore

White front side always
Scocca interna sempre bianca

PPL FINISHES / Finiture PPL

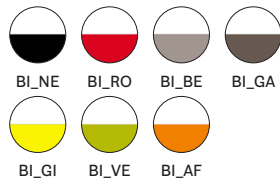

PACKING / Imballo



TECHNICAL DETAILS / Dettagli tecnici



For colours and finishes see at page 320
Per colori e finiture vedere da pagina 320

Tweet 893F

One-colour
Monocolore



SEAT Sedile	BACK Schienale	FRAME Telaio	BLACK POWDER COATED Verniciato nero
PPL	PPL	Ø 680	€ 273,00

Fire-retardant version available on request: surcharge **€ 33,00** (item 893F/CL1) - Minimum order 300 pcs each colour
Disponibile a richiesta la versione ignifuga: supplemento **€ 33,00** (art. 893F/CL1) - Ordine minimo 300 pz per colore

PPL FINISHES / Finiture PPL

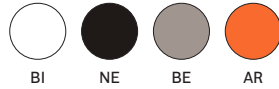

PACKING / Imballo



TECHNICAL DETAILS / Dettagli tecnici



Tweet 893F

Bicolour
Bicolore



SEAT Sedile	BACK Schienale	FRAME Telaio	BLACK POWDER COATED Verniciato nero
PPL	PPL	Ø 680	€ 273,00

Fire-retardant version available on request: surcharge **€ 33,00** (item 893F/CL1) - Minimum order 300 pcs each colour
Disponibile a richiesta la versione ignifuga: supplemento **€ 33,00** (art. 893F/CL1) - Ordine minimo 300 pz per colore

White front side always
Scocca interna sempre bianca

PPL FINISHES / Finiture PPL

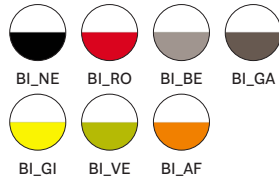

PACKING / Imballo



TECHNICAL DETAILS / Dettagli tecnici



Tweet 891/3

Gas lift device
Alzata a gas



SEAT Sedile	BACK Schienale	FRAME Telaio	WHITE/BLACK POWDER COATED Verniciato bianco/nero
PPL	PPL	Ø 750	€ 301,00

Fire-retardant version available on request: surcharge **€ 33,00** (item 891/3/CL1) - Minimum order 300 pcs each colour
Disponibile a richiesta la versione ignifuga: supplemento **€ 33,00** (art. 891/3/CL1) - Ordine minimo 300 pz per colore

White front side always
Scocca interna sempre bianca

PPL FINISHES / Finiture PPL



PACKING / Imballo



TECHNICAL DETAILS / Dettagli tecnici



Tweet 890/2

SOFT



SEAT Sedile	BACK Schienale	FRAME Telaio	POWDER COATED Verniciato	CHROMED Cromato	GOLD LACQUERED Laccato oro	ANTIQU BRASS Ottone anticato
C	C		€ 353,00	€ 353,00	€ 424,00	€ 439,00
D40+D44	D40+D44		€ 403,00	€ 403,00	€ 475,00	€ 489,00
E	E	Ø 14	€ 481,00	€ 481,00	€ 553,00	€ 567,00
G	G		€ 481,00	€ 481,00	€ 553,00	€ 567,00
H	H		€ 370,00	€ 370,00	€ 441,00	€ 455,00

Excluding / Escluso H140+H143
For fabrics see page 325
Per i tessuti si veda a p. 325

PACKING / Imballo



TECHNICAL DETAILS / Dettagli tecnici



SAFETY, STRENGTH and DURABILITY TESTS
Prove di sicurezza, resistenza e durata
EN 1728:2012+AC2013
EN 16139:2013 level 2

Tweet 897/2

SOFT



SEAT Sedile	BACK Schienale	FRAME Telaio	POWDER COATED Verniciato	CHROMED Cromato	GOLD LACQUERED Laccato oro	ANTIQU BRASS Ottone anticato
C	C		€ 367,00	€ 367,00	€ 439,00	€ 453,00
D40+D44	D40+D44		€ 418,00	€ 418,00	€ 489,00	€ 504,00
E	E	Ø 11	€ 496,00	€ 496,00	€ 567,00	€ 582,00
G	G		€ 496,00	€ 496,00	€ 567,00	€ 582,00
H	H		€ 384,00	€ 384,00	€ 455,00	€ 470,00

Excluding / Escluso H140+H143
For fabrics see page 325
Per i tessuti si veda a p. 325

PACKING / Imballo



TECHNICAL DETAILS / Dettagli tecnici



SAFETY, STRENGTH and DURABILITY TESTS
Prove di sicurezza, resistenza e durata
EN 1728:2012+AC2013
EN 16139:2013 level 2

Tweet 894/2

SOFT



SEAT Sedile	BACK Schienale	FRAME Telaio	CHROMED Cromato
C	C		€ 389,00
D40+D44	D40+D44		€ 439,00
E	E	Ø 11	€ 518,00
G	G		€ 518,00
H	H		€ 406,00

Excluding / Escluso H140+H143
For fabrics see page 325
Per i tessuti si veda a p. 325

PACKING / Imballo



TECHNICAL DETAILS / Dettagli tecnici

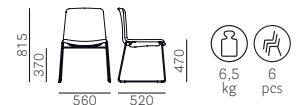

For colours and finishes see at page 320
Per colori e finiture vedere da pagina 320

Tweet 894/TT

Turning tablet only
Solo tavoletta girevole



TOP
Ripiano

€ 123,00

Chromed armrest Ø11 mm
Bracciolo in tondino Ø11 mm cromato

For item / Per articoli
894, 894/2

TABLET FINISH / Finitura tavoletta

Anti-fingerprint finish
Finitura anti-impronta

FNP_NE

PACKING / Imballo

2 pcs MC 0,031

TECHNICAL DETAILS / Dettagli tecnici

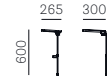

1,2
kg

Tweet 893/2

SOFT



SEAT Sedile	BACK Schienale	FRAME Telaio	WHITE/BLACK POWDER COATED Verniciato bianco/nero
C	C		€ 484,00
D40+D44	D40+D44		€ 536,00
E	E	Ø 680	€ 619,00
G	G		€ 619,00
H	H		€ 501,00

Excluding / Escluso H140+H143

For fabrics see page 325
Per i tessuti si veda a p. 325

PACKING / Imballo

1 pc KD
MC 0,189

TECHNICAL DETAILS / Dettagli tecnici



8,5
kg

Tweet 893F/2

SOFT



SEAT Sedile	BACK Schienale	FRAME Telaio	WHITE/BLACK POWDER COATED Verniciato bianco/nero
C	C		€ 514,00
D40+D44	D40+D44		€ 566,00
E	E	Ø 680	€ 649,00
G	G		€ 649,00
H	H		€ 531,00

Excluding / Escluso H140+H143

For fabrics see page 325
Per i tessuti si veda a p. 325

PACKING / Imballo

1 pc KD
MC 0,187

TECHNICAL DETAILS / Dettagli tecnici



8,5
kg

Tweet 891/4

SOFT
Gas lift device
Alzata a gas



SEAT Sedile	BACK Schienale	FRAME Telaio	WHITE/BLACK POWDER COATED Verniciato bianco/nero
C	C		€ 541,00
D40+D44	D40+D44		€ 595,00
E	E	Ø 750	€ 676,00
G	G		€ 676,00
H	H		€ 559,00

Excluding / Escluso H140+H143

For fabrics see page 325
Per i tessuti si veda a p. 325

PACKING / Imballo



TECHNICAL DETAILS / Dettagli tecnici



Tweet 895

One-colour
Monocolore



SEAT Sedile	BACK Schienale	FRAME Telaio	POWDER COATED Verniciato	CHROMED Cromato
PPL	PPL	Ø 14	€ 218,00 AR frame finish excluded Escluso telaio finitura AR	€ 218,00

Fire-retardant version available on request: surcharge **€ 33,00** (item 895/CL1) - Minimum order 300 pcs each colour
Disponibile a richiesta la versione ignifuga: supplemento **€ 33,00** (art. 895/CL1) - Ordine minimo 300 pz per colore

PPL FINISHES / Finiture PPL



PACKING / Imballo



TECHNICAL DETAILS / Dettagli tecnici



Tweet 895

Bicolour
Bicolore



SEAT Sedile	BACK Schienale	FRAME Telaio	POWDER COATED Verniciato	CHROMED Cromato
PPL	PPL	Ø 14	€ 218,00 GI frame finish excluded Escluso telaio finitura GI	€ 218,00

Fire-retardant version available on request: surcharge **€ 33,00** (item 895/CL1) - Minimum order 300 pcs each colour
Disponibile a richiesta la versione ignifuga: supplemento **€ 33,00** (art. 895/CL1) - Ordine minimo 300 pz per colore

White front side always
Scocca interna sempre bianca

PPL FINISHES / Finiture PPL



PACKING / Imballo



TECHNICAL DETAILS / Dettagli tecnici



For colours and finishes see at page 320
Per colori e finiture vedere da pagina 320



Tweet 898

One-colour
Monocolore



SEAT Sedile	BACK Schienale	FRAME Telaio	POWDER COATED Verniciato	CHROMED Cromato
PPL	PPL	Ø 11	€ 225,00 AR frame finish excluded Escluso telaio finitura AR	€ 240,00

Fire-retardant version available on request: surcharge **€ 33,00** (item 898/CL1) - Minimum order 300 pcs each colour
 Disponibile a richiesta la versione ignifuga: supplemento **€ 33,00** (art. 898/CL1) - Ordine minimo 300 pz per colore

PPL FINISHES / Finiture PPL

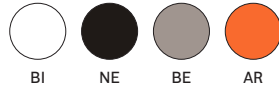

PACKING / Imballo



TECHNICAL DETAILS / Dettagli tecnici



Tweet 898

Bicolour
Bicolore



SEAT Sedile	BACK Schienale	FRAME Telaio	POWDER COATED Verniciato	CHROMED Cromato
PPL	PPL	Ø 11	€ 225,00 GI frame finish excluded Escluso telaio finitura GI	€ 240,00

Fire-retardant version available on request: surcharge **€ 33,00** (item 898/CL1) - Minimum order 300 pcs each colour
 Disponibile a richiesta la versione ignifuga: supplemento **€ 33,00** (art. 898/CL1) - Ordine minimo 300 pz per colore

White front side always
 Scocca interna sempre bianca

PPL FINISHES / Finiture PPL

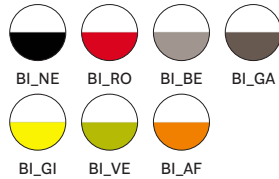

PACKING / Imballo



TECHNICAL DETAILS / Dettagli tecnici



Tweet 895/2

SOFT



SEAT Sedile	BACK Schienale	FRAME Telaio	POWDER COATED Verniciato	CHROMED Cromato	GOLD LACQUERED Laccato oro	ANTIQU BRASS Ottone anticato
C	C		€ 507,00	€ 507,00	€ 579,00	€ 593,00
D40÷D44	D40÷D44		€ 566,00	€ 566,00	€ 637,00	€ 652,00
E	E	Ø 14	€ 657,00	€ 657,00	€ 728,00	€ 743,00
G	G		€ 657,00	€ 657,00	€ 728,00	€ 743,00
H	H		€ 527,00	€ 527,00	€ 598,00	€ 613,00

Excluding / Escluso H140+H143
 For fabrics see page 325
 Per i tessuti si veda a p. 325

PACKING / Imballo



TECHNICAL DETAILS / Dettagli tecnici



For colours and finishes see at page 320
 Per colori e finiture vedere da pagina 320

Tweet 898/2

SOFT



SEAT Sedile	BACK Schienale	FRAME Telaio	POWDER COATED Verniciato	CHROMED Cromato	GOLD LACQUERED Laccato oro	ANTIQU BRASS Ottone antico
C	C		€ 515,00	€ 530,00	€ 601,00	€ 615,00
D40+D44	D40+D44		€ 575,00	€ 589,00	€ 661,00	€ 675,00
E	E	Ø 11	€ 666,00	€ 680,00	€ 752,00	€ 766,00
G	G		€ 666,00	€ 680,00	€ 752,00	€ 766,00
H	H		€ 536,00	€ 550,00	€ 622,00	€ 636,00

Excluding / Escluso H140+H143
For fabrics see page 325
Per i tessuti si veda a p. 325

PACKING / Imballo



TECHNICAL DETAILS / Dettagli tecnici

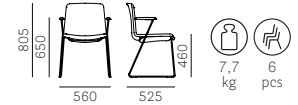

Tweet 892



SEAT Sedile	BACK Schienale	FRAME Telaio	POWDER COATED Verniciato	CHROMED Cromato
PPL	PPL	Ø 14 H650	€ 195,00 AR, GI frame finish excluded Escluso telaio finitura AR, GI	€ 195,00

Fire-retardant version available on request: surcharge € 33,00 (item 892/CL1) - Minimum order 300 pcs each colour
Disponibile a richiesta la versione ignifuga: supplemento € 33,00 (art. 892/CL1) - Ordine minimo 300 pz per colore

PPL FINISHES / Finiture PPL

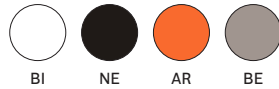

White front side always / Scocca interna sempre bianca



PACKING / Imballo



TECHNICAL DETAILS / Dettagli tecnici



SAFETY, STRENGTH and DURABILITY TESTS
Prove di sicurezza, resistenza e durata
EN 1728:2012+AC2013
EN 16139:2013 level 2



Tweet 896



SEAT Sedile	BACK Schienale	FRAME Telaio	POWDER COATED Verniciato	CHROMED Cromato
PPL	PPL	Ø 14 H750	€ 198,00 AR, GI frame finish excluded Escluso telaio finitura AR, GI	€ 198,00

Fire-retardant version available on request: surcharge € 33,00 (item 896/CL1) - Minimum order 300 pcs each colour
Disponibile a richiesta la versione ignifuga: supplemento € 33,00 (art. 896/CL1) - Ordine minimo 300 pz per colore

PPL FINISHES / Finiture PPL



White front side always / Scocca interna sempre bianca



PACKING / Imballo



TECHNICAL DETAILS / Dettagli tecnici



SAFETY, STRENGTH and DURABILITY TESTS
Prove di sicurezza, resistenza e durata
EN 1728:2012+AC2013
EN 16139:2013 level 2



For colours and finishes see at page 320
Per colori e finiture vedere da pagina 320

Tweet 899



SEAT Sedile	BACK Schienale	FRAME Telaio	POWDER COATED Verniciato	CHROMED Cromato
PPL	PPL	Ø 12 H750	€ 179,00 AR, GI frame finish excluded Escluso telaio finitura AR, GI	€ 179,00

Fire-retardant version available on request: surcharge **€ 33,00** (item 899/CL1) - Minimum order 300 pcs each colour
Disponibile a richiesta la versione ignifuga: supplemento **€ 33,00** (art. 899/CL1) - Ordine minimo 300 pz per colore

PPL FINISHES / Finiture PPL



White front side always / Scocca interna sempre bianca



PACKING / Imballo



TECHNICAL DETAILS / Dettagli tecnici



Tweet 892/2

SOFT



SEAT Sedile	BACK Schienale	FRAME Telaio	POWDER COATED Verniciato	CHROMED Cromato	GOLD LACQUERED Laccato oro	ANTIQU BRASS Ottone anticato
C	C		€ 435,00	€ 435,00	€ 510,00	€ 532,00
D40+D44	D40+D44		€ 488,00	€ 488,00	€ 563,00	€ 585,00
E	E	Ø 14 H660	€ 570,00	€ 570,00	€ 645,00	€ 667,00
G	G		€ 570,00	€ 570,00	€ 645,00	€ 667,00
H	H		€ 454,00	€ 454,00	€ 528,00	€ 552,00

Excluding / Escluso H140+H143

For fabrics see page 325
Per i tessuti si veda a p. 325

PACKING / Imballo



TECHNICAL DETAILS / Dettagli tecnici



SAFETY, STRENGTH and DURABILITY TESTS
Prove di sicurezza, resistenza e durata
EN 1728:2012+AC2013
EN 16139:2013 level 2

Tweet 896/2

SOFT



SEAT Sedile	BACK Schienale	FRAME Telaio	POWDER COATED Verniciato	CHROMED Cromato	GOLD LACQUERED Laccato oro	ANTIQU BRASS Ottone anticato
C	C		€ 439,00	€ 439,00	€ 514,00	€ 536,00
D40+D44	D40+D44		€ 491,00	€ 491,00	€ 566,00	€ 589,00
E	E	Ø 14 H760	€ 574,00	€ 574,00	€ 649,00	€ 671,00
G	G		€ 574,00	€ 574,00	€ 649,00	€ 671,00
H	H		€ 457,00	€ 457,00	€ 531,00	€ 554,00

Excluding / Escluso H140+H143

For fabrics see page 325
Per i tessuti si veda a p. 325

PACKING / Imballo



TECHNICAL DETAILS / Dettagli tecnici



SAFETY, STRENGTH and DURABILITY TESTS
Prove di sicurezza, resistenza e durata
EN 1728:2012+AC2013
EN 16139:2013 level 2

For colours and finishes see at page 320
Per colori e finiture vedere da pagina 320

Tweet 899/2

SOFT



SEAT Sedile	BACK Schienale	FRAME Telaio	POWDER COATED Verniciato	CHROMED Cromato	GOLD LACQUERED Laccato oro	ANTIQUÉ BRASS Ottone anticato
C	C		€ 419,00	€ 419,00	€ 494,00	€ 517,00
D40+D44	D40+D44		€ 471,00	€ 471,00	€ 546,00	€ 569,00
E	E	Ø 12 H760	€ 554,00	€ 554,00	€ 628,00	€ 652,00
G	G		€ 554,00	€ 554,00	€ 628,00	€ 652,00
H Excluding / Escluso H140+H143	H		€ 436,00	€ 436,00	€ 511,00	€ 535,00

For fabrics see page 325
Per i tessuti si veda a p. 325

PACKING / Imballo



TECHNICAL DETAILS / Dettagli tecnici



Twig 429



SEAT Sedile	BACK Schienale	FRAME Telaio	OAK Rovere	BEECH (FS-AN) Faggio
C Excluding / Escluso C36+C39			€ 303,00	€ 276,00
G	RS-W-N1- GC-BI	RS-W-N1- GC-BI	€ 335,00	€ 307,00
H Excluding / Escluso H140+H143	FS-AN	FS-AN	€ 320,00	€ 279,00
P			€ 381,00	€ 354,00

For fabrics see page 325
Per i tessuti si veda a p. 325

FINISHES / Finiture

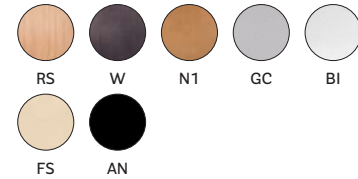

PACKING / Imballo



TECHNICAL DETAILS / Dettagli tecnici

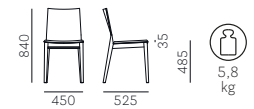

SAFETY, STRENGTH and DURABILITY TESTS
Prove di sicurezza, resistenza e durata
EN 1728:2000

Twig 429/2



SEAT Sedile	BACK Schienale	FRAME Telaio	OAK Rovere	BEECH (FS-AN) Faggio
C Excluding / Escluso C36+C39			€ 327,00	€ 299,00
G	RS-W-N1- GC-BI	RS-W-N1- GC-BI	€ 358,00	€ 332,00
H Excluding / Escluso H140+H143	FS-AN	FS-AN	€ 328,00	€ 302,00
P			€ 405,00	€ 377,00

For fabrics see page 325
Per i tessuti si veda a p. 325

FINISHES / Finiture



PACKING / Imballo



TECHNICAL DETAILS / Dettagli tecnici

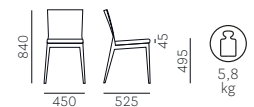

SAFETY, STRENGTH and DURABILITY TESTS
Prove di sicurezza, resistenza e durata
EN 1728:2000

For colours and finishes see at page 320
Per colori e finiture vedere da pagina 320

TX 4403F

S_TX



SEAT Sedile	FRAME Telaio	BRUSHED S/STEEL Inox satinato	POLISHED S/STEEL Inox lucidato
C Excluding / Escluso C36+C39		€ 241,00	€ 260,00
G	Ø 400	€ 285,00	€ 305,00
H Excluding / Escluso H140+H143		€ 244,00	€ 263,00
P		€ 301,00	€ 320,00

For fabrics see page 325
Per i tessuti si veda a p. 325

PACKING / Imballo



TECHNICAL DETAILS / Dettagli tecnici



TX 4403G

S_TX



SEAT Sedile	FRAME Telaio	BRUSHED S/STEEL Inox satinato	POLISHED S/STEEL Inox lucidato
C Excluding / Escluso C36+C39		€ 289,00	€ 309,00
G	Ø 400	€ 333,00	€ 353,00
H Excluding / Escluso H140+H143		€ 292,00	€ 311,00
P		€ 349,00	€ 368,00

For fabrics see page 325
Per i tessuti si veda a p. 325

PACKING / Imballo



TECHNICAL DETAILS / Dettagli tecnici



TX 4405F

S_TX



SEAT Sedile	FRAME Telaio	BRUSHED S/STEEL Inox satinato
C Excluding / Escluso C36+C39		€ 379,00
G	Ø 400	€ 423,00
H Excluding / Escluso H140+H143		€ 381,00
P		€ 439,00

For fabrics see page 325
Per i tessuti si veda a p. 325

PACKING / Imballo



TECHNICAL DETAILS / Dettagli tecnici

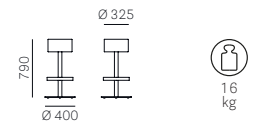

TX 4405G

S_TX



SEAT Sedile	FRAME Telaio	BRUSHED S/STEEL Inox satinato
C Excluding / Escluso C36+C39		€ 428,00
G	Ø 400	€ 472,00
H Excluding / Escluso H140+H143		€ 431,00
P		€ 488,00

For fabrics see page 325
Per i tessuti si veda a p. 325

PACKING / Imballo

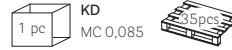

TECHNICAL DETAILS / Dettagli tecnici

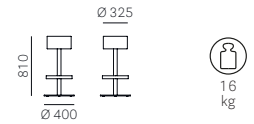

TX 4407



SEAT Sedile	FRAME Telaio	BRUSHED S/STEEL Inox satinato
RS-W	Ø 400	€ 436,00
EB-ZB		

FINISHES / Finiture

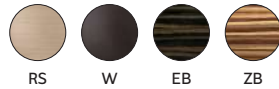

PACKING / Imballo



TECHNICAL DETAILS / Dettagli tecnici

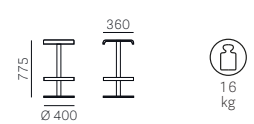

TX 4407F



SEAT Sedile	FRAME Telaio	BRUSHED S/STEEL Inox satinato
RS-W	Ø 400	€ 388,00
EB-ZB		

FINISHES / Finiture

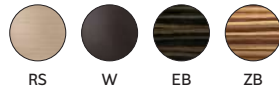

PACKING / Imballo



TECHNICAL DETAILS / Dettagli tecnici

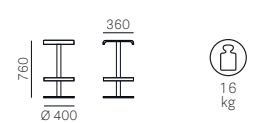

Vic 655

ABS shell below cover
Guscio sottoscocca in ABS

SEAT Sedile	BACK Schienale	FRAME Telaio	ASH Frassino
C Excluding / Escluso C36+C39 D40+D44	C D40+D44		€ 862,00
E	E		€ 912,00
G	G	FR-N1 GC-AN	€ 1.061,00
H Excluding / Escluso H120+H127, H140+H143	H		€ 987,00
P	P		€ 879,00
PF *	PF *		€ 1.130,00
			€ 1.176,00

*Perforated mid-grain leather (inner part of the back, upper part of the seat)
Pelle forata (parte interna dello schienale e parte superiore del sedile)For fabrics see page 325
Per i tessuti si veda a p. 325

WOODEN FINISHES / Finiture legno



FR N1 GC AN

ABS SHELL BELOW COVER / Guscio sottoscocca in ABS



NE

PACKING / Imballo

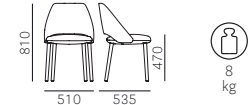

TECHNICAL DETAILS / Dettagli tecnici

SAFETY, STRENGTH and DURABILITY TESTS
Prove di sicurezza, resistenza e durata
EN 1728:2012+AC2013
EN 16139:2013 level 2

Vic Metal 656

Upholstered shell below cover
Guscio sottoscocca imbottito

SEAT Sedile	BACK Schienale	FRAME Telaio	POWDER COATED Verniciato	SATINIZED Satinato	BRUSHED BRONZE Bronzo satinato	ANTIQU BRASS Ottone anticato	TITANIUM Titanio
C Excluding / Escluso C36+C39 D40+D44	C D40+D44		€ 909,00	€ 966,00	€ 966,00	€ 966,00	€ 966,00
E	E		€ 972,00	€ 1.029,00	€ 1.029,00	€ 1.029,00	€ 1.029,00
G	G	Ø 25	€ 1.141,00	€ 1.198,00	€ 1.198,00	€ 1.198,00	€ 1.198,00
H Excluding / Escluso H120+H127, H140+H143	H		€ 1.068,00	€ 1.125,00	€ 1.125,00	€ 1.125,00	€ 1.125,00
P	P		€ 930,00	€ 987,00	€ 987,00	€ 987,00	€ 987,00
PF *	PF *		€ 1.219,00	€ 1.276,00	€ 1.276,00	€ 1.276,00	€ 1.276,00
			€ 1.263,00	€ 1.320,00	€ 1.320,00	€ 1.320,00	€ 1.320,00

*Perforated mid-grain leather (inner part of the back, upper part of the seat)
Pelle forata (parte interna dello schienale e parte superiore del sedile)For fabrics see page 325
Per i tessuti si veda a p. 325

PACKING / Imballo



TECHNICAL DETAILS / Dettagli tecnici

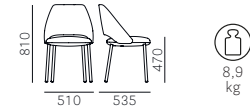

Vic Metal 657

ABS shell below cover
Guscio sottoscocca in ABS

SEAT Sedile	BACK Schienale	FRAME Telaio	POWDER COATED Verniciato	SATINIZED Satinato	BRUSHED BRONZE Bronzo satinato	ANTIQU BRASS Ottone anticato	TITANIUM Titanio
C Excluding / Escluso C36+C39 D40+D44	C D40+D44		€ 834,00	€ 891,00	€ 891,00	€ 891,00	€ 891,00
E	E		€ 883,00	€ 940,00	€ 940,00	€ 940,00	€ 940,00
G	G	Ø 25	€ 1.033,00	€ 1.090,00	€ 1.090,00	€ 1.090,00	€ 1.090,00
H Excluding / Escluso H120+H127, H140+H143	H		€ 959,00	€ 1.016,00	€ 1.016,00	€ 1.016,00	€ 1.016,00
P	P		€ 851,00	€ 908,00	€ 908,00	€ 908,00	€ 908,00
PF *	PF *		€ 1.102,00	€ 1.159,00	€ 1.159,00	€ 1.159,00	€ 1.159,00
			€ 1.147,00	€ 1.204,00	€ 1.204,00	€ 1.204,00	€ 1.204,00

*Perforated mid-grain leather (inner part of the back, upper part of the seat)
Pelle forata (parte interna dello schienale e parte superiore del sedile)

ABS SHELL BELOW COVER / Guscio sottoscocca in ABS



NE

For fabrics see page 325
Per i tessuti si veda a p. 325

PACKING / Imballo



TECHNICAL DETAILS / Dettagli tecnici

For colours and finishes see at page 320
Per colori e finiture vedere da pagina 320

Vic 645

ABS shell below cover
Guscio sottoscocca in ABS

SEAT Sedile	BACK Schienale	FRAME Telaio	ASH Frassino
C Excluding / Escluso C36+C39 D40+D44	C D40+D44		€ 926,00
E	E		€ 982,00
G	G	FR-N1 GC-AN	€ 1.144,00
H Excluding / Escluso H120+H127, P	H H140+H143		€ 1.068,00
PF *	PF *		€ 944,00
			€ 1.264,00
			€ 1.324,00

*Perforated mid-grain leather (inner part of the back, upper part of the seat)
Pelle forata (parte interna dello schienale e parte superiore del sedile)For fabrics see page 325
Per i tessuti si veda a p. 325

FINISHES / Finiture

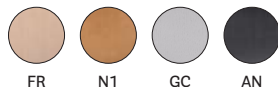

FR N1 GC AN

ABS SHELL BELOW COVER / Guscio sottoscocca in ABS



NE

PACKING / Imballo



TECHNICAL DETAILS / Dettagli tecnici

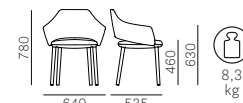

SAFETY, STRENGTH and DURABILITY TESTS

Prove di sicurezza, resistenza e durata
EN 1728:2012+AC2013
EN 16139:2013 level 2

Vic Metal 646

Upholstered shell below cover
Guscio sottoscocca imbottito

SEAT Sedile	BACK Schienale	FRAME Telaio	POWDER COATED Verniciato	SATINIZED Satinato	BRUSHED BRONZE Bronzo satinato	ANTIQU BRASS Ottone anticato	TITANIUM Titanio
C Excluding / Escluso C36+C39 D40+D44	C D40+D44		€ 973,00	€ 1.030,00	€ 1.030,00	€ 1.030,00	€ 1.030,00
E	E		€ 1.042,00	€ 1.099,00	€ 1.099,00	€ 1.099,00	€ 1.099,00
G	G	Ø 25	€ 1.225,00	€ 1.282,00	€ 1.282,00	€ 1.282,00	€ 1.282,00
H Excluding / Escluso H120+H127, P	H H140+H143		€ 1.148,00	€ 1.206,00	€ 1.206,00	€ 1.206,00	€ 1.206,00
PF *	PF *		€ 996,00	€ 1.053,00	€ 1.053,00	€ 1.053,00	€ 1.053,00
			€ 1.351,00	€ 1.408,00	€ 1.408,00	€ 1.408,00	€ 1.408,00
			€ 1.411,00	€ 1.468,00	€ 1.468,00	€ 1.468,00	€ 1.468,00

*Perforated mid-grain leather (inner part of the back, upper part of the seat)
Pelle forata (parte interna dello schienale e parte superiore del sedile)For fabrics see page 325
Per i tessuti si veda a p. 325

PACKING / Imballo



TECHNICAL DETAILS / Dettagli tecnici

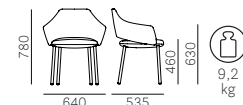

Vic Metal 647

ABS shell below cover
Guscio sottoscocca in ABS

SEAT Sedile	BACK Schienale	FRAME Telaio	POWDER COATED Verniciato	SATINIZED Satinato	BRUSHED BRONZE Bronzo satinato	ANTIQU BRASS Ottone anticato	TITANIUM Titanio
C Excluding / Escluso C36+C39 D40+D44	C D40+D44		€ 897,00	€ 955,00	€ 955,00	€ 955,00	€ 955,00
E	E		€ 953,00	€ 1.011,00	€ 1.011,00	€ 1.011,00	€ 1.011,00
G	G	Ø 25	€ 1.116,00	€ 1.173,00	€ 1.173,00	€ 1.173,00	€ 1.173,00
H Excluding / Escluso H120+H127, P	H H140+H143		€ 1.039,00	€ 1.096,00	€ 1.096,00	€ 1.096,00	€ 1.096,00
PF *	PF *		€ 916,00	€ 973,00	€ 973,00	€ 973,00	€ 973,00
			€ 1.235,00	€ 1.293,00	€ 1.293,00	€ 1.293,00	€ 1.293,00
			€ 1.295,00	€ 1.352,00	€ 1.352,00	€ 1.352,00	€ 1.352,00

*Perforated mid-grain leather (inner part of the back, upper part of the seat)
Pelle forata (parte interna dello schienale e parte superiore del sedile)

ABS SHELL BELOW COVER / Guscio sottoscocca in ABS



NE

For fabrics see page 325
Per i tessuti si veda a p. 325

PACKING / Imballo



TECHNICAL DETAILS / Dettagli tecnici

For colours and finishes see at page 320
Per colori e finiture vedere da pagina 320

Vic Metal 659

Upholstered shell below cover
Guscio sottoscocca imbottito

SEAT Sedile	BACK Schienale	FRAME Telaio	POWDER COATED Verniciato	SATINIZED Satinato	BRUSHED BRONZE Bronzo satinato	ANTIQU BRASS Ottone anticato	TITANIUM Titanio
C Excluding / Escluso C36+C39 D40+D44	C D40+D44		€ 981,00	€ 1.082,00	€ 1.082,00	€ 1.082,00	€ 1.082,00
E	E		€ 1.043,00	€ 1.144,00	€ 1.144,00	€ 1.144,00	€ 1.144,00
G	G	H660	€ 1.212,00	€ 1.313,00	€ 1.313,00	€ 1.313,00	€ 1.313,00
H Excluding / Escluso H120+H127, H140+H143	H D40+D44		€ 1.139,00	€ 1.241,00	€ 1.241,00	€ 1.241,00	€ 1.241,00
P	P		€ 1.001,00	€ 1.104,00	€ 1.104,00	€ 1.104,00	€ 1.104,00
PF *	PF *		€ 1.290,00	€ 1.391,00	€ 1.391,00	€ 1.391,00	€ 1.391,00
			€ 1.334,00	€ 1.436,00	€ 1.436,00	€ 1.436,00	€ 1.436,00

*Perforated mid-grain leather (inner part of the back, upper part of the seat)
Pelle forata (parte interna dello schienale e parte superiore del sedile)For fabrics see page 325
Per i tessuti si veda a p. 325

PACKING / Imballo



TECHNICAL DETAILS / Dettagli tecnici

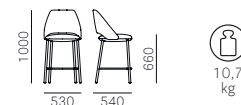

Vic Metal 659/2

ABS shell below cover
Guscio sottoscocca in ABS

SEAT Sedile	BACK Schienale	FRAME Telaio	POWDER COATED Verniciato	SATINIZED Satinato	BRUSHED BRONZE Bronzo satinato	ANTIQU BRASS Ottone anticato	TITANIUM Titanio
C Excluding / Escluso C36+C39 D40+D44	C D40+D44		€ 905,00	€ 1.007,00	€ 1.007,00	€ 1.007,00	€ 1.007,00
E	E		€ 955,00	€ 1.056,00	€ 1.056,00	€ 1.056,00	€ 1.056,00
G	G	H660	€ 1.104,00	€ 1.206,00	€ 1.206,00	€ 1.206,00	€ 1.206,00
H Excluding / Escluso H120+H127, H140+H143	H D40+D44		€ 1.030,00	€ 1.133,00	€ 1.133,00	€ 1.133,00	€ 1.133,00
P	P		€ 922,00	€ 1.024,00	€ 1.024,00	€ 1.024,00	€ 1.024,00
PF *	PF *		€ 1.173,00	€ 1.276,00	€ 1.276,00	€ 1.276,00	€ 1.276,00
			€ 1.219,00	€ 1.320,00	€ 1.320,00	€ 1.320,00	€ 1.320,00

*Perforated mid-grain leather (inner part of the back, upper part of the seat)
Pelle forata (parte interna dello schienale e parte superiore del sedile)

ABS SHELL BELOW COVER / Guscio sottoscocca in ABS

PACKING / Imballo



TECHNICAL DETAILS / Dettagli tecnici

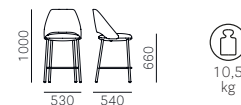

NE

For fabrics see page 325
Per i tessuti si veda a p. 325

Vic Metal 658

Upholstered shell below cover
Guscio sottoscocca imbottito

SEAT Sedile	BACK Schienale	FRAME Telaio	POWDER COATED Verniciato	SATINIZED Satinato	BRUSHED BRONZE Bronzo satinato	ANTIQU BRASS Ottone anticato	TITANIUM Titanio
C Excluding / Escluso C36+C39 D40+D44	C D40+D44		€ 987,00	€ 1.096,00	€ 1.096,00	€ 1.096,00	€ 1.096,00
E	E		€ 1.051,00	€ 1.159,00	€ 1.159,00	€ 1.159,00	€ 1.159,00
G	G	H760	€ 1.220,00	€ 1.328,00	€ 1.328,00	€ 1.328,00	€ 1.328,00
H Excluding / Escluso H120+H127, H140+H143	H D40+D44		€ 1.147,00	€ 1.255,00	€ 1.255,00	€ 1.255,00	€ 1.255,00
P	P		€ 1.009,00	€ 1.118,00	€ 1.118,00	€ 1.118,00	€ 1.118,00
PF *	PF *		€ 1.297,00	€ 1.406,00	€ 1.406,00	€ 1.406,00	€ 1.406,00
			€ 1.341,00	€ 1.450,00	€ 1.450,00	€ 1.450,00	€ 1.450,00

*Perforated mid-grain leather (inner part of the back, upper part of the seat)
Pelle forata (parte interna dello schienale e parte superiore del sedile)For fabrics see page 325
Per i tessuti si veda a p. 325

PACKING / Imballo

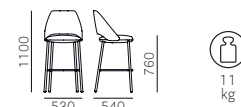

TECHNICAL DETAILS / Dettagli tecnici

For colours and finishes see at page 320
Per colori e finiture vedere da pagina 320

Vic Metal 658/2

ABS shell below cover
Guscio sottoscocca in ABS

SEAT Sedile	BACK Schienale	FRAME Telaio	POWDER COATED Verniciato	SATINIZED Satinato	BRUSHED BRONZE Bronzo satinato	ANTIQU BRASS Ottone anticato	TITANIUM Titanio
C Excluding / Escluso C36+C39 D40+D44	C D40+D44		€ 912,00	€ 1.021,00	€ 1.021,00	€ 1.021,00	€ 1.021,00
E	E		€ 1.111,00	€ 1.220,00	€ 1.220,00	€ 1.220,00	€ 1.220,00
G	G	H760	€ 1.038,00	€ 1.147,00	€ 1.147,00	€ 1.147,00	€ 1.147,00
H Excluding / Escluso H120+H127, P	H H140+H143		€ 929,00	€ 1.038,00	€ 1.038,00	€ 1.038,00	€ 1.038,00
PF *	PF *		€ 1.181,00	€ 1.290,00	€ 1.290,00	€ 1.290,00	€ 1.290,00
			€ 1.225,00	€ 1.334,00	€ 1.334,00	€ 1.334,00	€ 1.334,00

*Perforated mid-grain leather (inner part of the back, upper part of the seat)
Pelle forata (parte interna dello schienale e parte superiore del sedile)

ABS SHELL BELOW COVER / Guscio sottoscocca in ABS



NE

For fabrics see page 325
Per i tessuti si veda a p. 325

PACKING / Imballo



TECHNICAL DETAILS / Dettagli tecnici

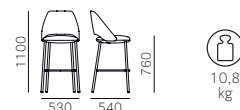

Vic Metal 649

Upholstered shell below cover
Guscio sottoscocca imbottito

SEAT Sedile	BACK Schienale	FRAME Telaio	POWDER COATED Verniciato	SATINIZED Satinato	BRUSHED BRONZE Bronzo satinato	ANTIQU BRASS Ottone anticato	TITANIUM Titanio
C Excluding / Escluso C36+C39 D40+D44	C D40+D44		€ 1.044,00	€ 1.147,00	€ 1.147,00	€ 1.147,00	€ 1.147,00
E	E		€ 1.113,00	€ 1.215,00	€ 1.215,00	€ 1.215,00	€ 1.215,00
G	G	H650	€ 1.297,00	€ 1.398,00	€ 1.398,00	€ 1.398,00	€ 1.398,00
H Excluding / Escluso H120+H127, P	H H140+H143		€ 1.220,00	€ 1.321,00	€ 1.321,00	€ 1.321,00	€ 1.321,00
PF *	PF *		€ 1.068,00	€ 1.169,00	€ 1.169,00	€ 1.169,00	€ 1.169,00
			€ 1.423,00	€ 1.524,00	€ 1.524,00	€ 1.524,00	€ 1.524,00
			€ 1.482,00	€ 1.584,00	€ 1.584,00	€ 1.584,00	€ 1.584,00

*Perforated mid-grain leather (inner part of the back, upper part of the seat)
Pelle forata (parte interna dello schienale e parte superiore del sedile)For fabrics see page 325
Per i tessuti si veda a p. 325

PACKING / Imballo



TECHNICAL DETAILS / Dettagli tecnici

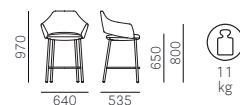

SAFETY, STRENGTH and DURABILITY TESTS

Prove di sicurezza, resistenza e durata

EN 1728:2012+AC2013

EN 16139:2013 level 2

Vic Metal 649/2

ABS shell below cover
Guscio sottoscocca in ABS

SEAT Sedile	BACK Schienale	FRAME Telaio	POWDER COATED Verniciato	SATINIZED Satinato	BRUSHED BRONZE Bronzo satinato	ANTIQU BRASS Ottone anticato	TITANIUM Titanio
C Excluding / Escluso C36+C39 D40+D44	C D40+D44		€ 969,00	€ 1.070,00	€ 1.070,00	€ 1.070,00	€ 1.070,00
E	E		€ 1.025,00	€ 1.126,00	€ 1.126,00	€ 1.126,00	€ 1.126,00
G	G	H650	€ 1.187,00	€ 1.290,00	€ 1.290,00	€ 1.290,00	€ 1.290,00
H Excluding / Escluso H120+H127, P	H H140+H143		€ 1.111,00	€ 1.212,00	€ 1.212,00	€ 1.212,00	€ 1.212,00
PF *	PF *		€ 987,00	€ 1.090,00	€ 1.090,00	€ 1.090,00	€ 1.090,00
			€ 1.307,00	€ 1.408,00	€ 1.408,00	€ 1.408,00	€ 1.408,00
			€ 1.367,00	€ 1.468,00	€ 1.468,00	€ 1.468,00	€ 1.468,00

*Perforated mid-grain leather (inner part of the back, upper part of the seat)
Pelle forata (parte interna dello schienale e parte superiore del sedile)

ABS SHELL BELOW COVER / Guscio sottoscocca in ABS



NE

For fabrics see page 325
Per i tessuti si veda a p. 325

PACKING / Imballo



TECHNICAL DETAILS / Dettagli tecnici



SAFETY, STRENGTH and DURABILITY TESTS

Prove di sicurezza, resistenza e durata

EN 1728:2012+AC2013

EN 16139:2013 level 2

For colours and finishes see at page 320
Per colori e finiture vedere da pagina 320

Vic Metal 648

Upholstered shell below cover
Guscio sottoscocca imbottito



SEAT Sedile	BACK Schienale	FRAME Telaio	POWDER COATED Verniciato	SATINIZED Satinato	BRUSHED BRONZE Bronzo satinato	ANTIQU BRASS Ottone anticato	TITANIUM Titanio
C Excluding / Escluso C36+C39 D40+D44	C D40+D44		€ 1.052,00	€ 1.161,00	€ 1.161,00	€ 1.161,00	€ 1.161,00
E	E		€ 1.121,00	€ 1.229,00	€ 1.229,00	€ 1.229,00	€ 1.229,00
G	G	H750	€ 1.304,00	€ 1.412,00	€ 1.412,00	€ 1.412,00	€ 1.412,00
H Excluding / Escluso H120+H127, H140+H143	H P		€ 1.226,00	€ 1.336,00	€ 1.336,00	€ 1.336,00	€ 1.336,00
P	P		€ 1.076,00	€ 1.183,00	€ 1.183,00	€ 1.183,00	€ 1.183,00
PF *	PF *		€ 1.429,00	€ 1.538,00	€ 1.538,00	€ 1.538,00	€ 1.538,00
			€ 1.490,00	€ 1.598,00	€ 1.598,00	€ 1.598,00	€ 1.598,00

*Perforated mid-grain leather (inner part of the back, upper part of the seat)
Pelle forata (parte interna dello schienale e parte superiore del sedile)

For fabrics see page 325
Per i tessuti si veda a p. 325

PACKING / Imballo



TECHNICAL DETAILS / Dettagli tecnici



SAFETY, STRENGTH and DURABILITY TESTS
Prove di sicurezza, resistenza e durata
EN 1728:2012+AC2013
EN 16139:2013 level 2

Vic Metal 648/2

ABS shell below cover
Guscio sottoscocca in ABS



SEAT Sedile	BACK Schienale	FRAME Telaio	POWDER COATED Verniciato	SATINIZED Satinato	BRUSHED BRONZE Bronzo satinato	ANTIQU BRASS Ottone anticato	TITANIUM Titanio
C Excluding / Escluso C36+C39 D40+D44	C D40+D44		€ 977,00	€ 1.085,00	€ 1.085,00	€ 1.085,00	€ 1.085,00
E	E		€ 1.033,00	€ 1.141,00	€ 1.141,00	€ 1.141,00	€ 1.141,00
G	G	H750	€ 1.195,00	€ 1.304,00	€ 1.304,00	€ 1.304,00	€ 1.304,00
H Excluding / Escluso H120+H127, H140+H143	H P		€ 1.118,00	€ 1.226,00	€ 1.226,00	€ 1.226,00	€ 1.226,00
P	P		€ 995,00	€ 1.104,00	€ 1.104,00	€ 1.104,00	€ 1.104,00
PF *	PF *		€ 1.313,00	€ 1.423,00	€ 1.423,00	€ 1.423,00	€ 1.423,00
			€ 1.373,00	€ 1.482,00	€ 1.482,00	€ 1.482,00	€ 1.482,00

*Perforated mid-grain leather (inner part of the back, upper part of the seat)
Pelle forata (parte interna dello schienale e parte superiore del sedile)

ABS SHELL BELOW COVER / Guscio sottoscocca in ABS



NE

For fabrics see page 325
Per i tessuti si veda a p. 325

PACKING / Imballo



TECHNICAL DETAILS / Dettagli tecnici

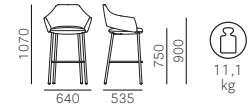

SAFETY, STRENGTH and DURABILITY TESTS
Prove di sicurezza, resistenza e durata
EN 1728:2012+AC2013
EN 16139:2013 level 2

Volt 670



SEAT Sedile	BACK Schienale	FRAME Telaio	POLYPROPYLENE Polipropilene
PPL	PPL	PPL	€ 84,00

PPL FINISHES / Finiture PPL

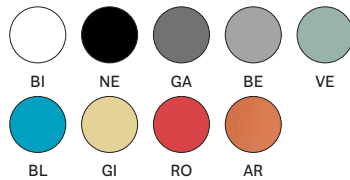

For colours and finishes see at page 320
Per colori e finiture vedere da pagina 320

PACKING / Imballo



TECHNICAL DETAILS / Dettagli tecnici



SAFETY, STRENGTH and DURABILITY TESTS
Prove di sicurezza, resistenza e durata
EN 1728:2012+AC2013
EN 16139:2013 level 2
ANSI-BIFMA X5.1-2017



Volt 670/CL1

Fire retardant version
Versione ignifuga



SEAT Sedile	BACK Schienale	FRAME Telaio	POLYPROPYLENE Polipropilene
PPL	PPL	PPL	€ 121,00

Minimum order 100 pcs
Ordine minimo 100 pz

PPL FINISHES / Finiture PPL



BI

PACKING / Imballo



MC 0,335

TECHNICAL DETAILS / Dettagli tecnici



4,5 kg
13 pcs

SAFETY, STRENGTH and DURABILITY TESTS
Prove di sicurezza, resistenza e durata
EN 1728:2012+AC2013
EN 16139:2013 level 2
ANSI-BIFMA X5.1-2017

Volt 671



SEAT Sedile	BACK Schienale	FRAME Telaio	FABRIC Tessuto
C83+C89; C100+C101 C110+C122	C83+C89; C100+C101 C110+C122		€ 286,00
C90+C95	C90+C95	PPL	€ 286,00
D40+D44	D40+D44		€ 293,00

For fabrics see page 325
Per i tessuti si veda a p. 325

PPL FINISHES / Finiture PPL



BI

NE

GA

BE

VE



BL



GI



RO



AR

PACKING / Imballo



MC 0,31

TECHNICAL DETAILS / Dettagli tecnici



6,5 kg
8 pcs

SAFETY, STRENGTH and DURABILITY TESTS
Prove di sicurezza, resistenza e durata
EN 1728:2012+AC2013
EN 16139:2013 level 2
ANSI-BIFMA X5.1-2017

Volt 671/2



SEAT Sedile	BACK Schienale	FRAME Telaio	FABRIC Tessuto
C Excluding / Escluso C36+C39			€ 182,00
D40+D44			€ 192,00
G	PPL	PPL	€ 205,00
H Excluding / Escluso H140+H143			€ 185,00

For fabrics see page 325
Per i tessuti si veda a p. 325

PPL FINISHES / Finiture PPL



BI

NE

GA

BE

VE



BL



GI



RO



AR

PACKING / Imballo



MC 0,31

TECHNICAL DETAILS / Dettagli tecnici



5,8 kg
8 pcs

SAFETY, STRENGTH and DURABILITY TESTS
Prove di sicurezza, resistenza e durata
EN 1728:2012+AC2013
EN 16139:2013 level 2
ANSI-BIFMA X5.1-2017

Volt 675



SEAT Sedile	BACK Schienale	FRAME Telaio	POLYPROPYLENE Polipropilene
PPL	PPL	PPL	€ 98,00

PPL FINISHES / Finiture PPL

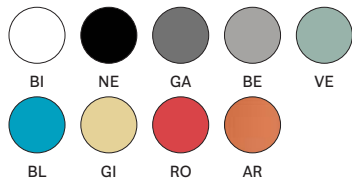

SAFETY, STRENGTH and DURABILITY TESTS
 Prove di sicurezza, resistenza e durata
 EN 1728:2012+AC2013
 EN 16139:2013 level 2

PACKING / Imballo



TECHNICAL DETAILS / Dettagli tecnici

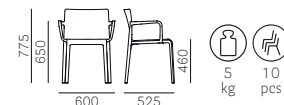

Volt 675/CL1

Fire retardant version
 Versione ignifuga



SEAT Sedile	BACK Schienale	FRAME Telaio	POLYPROPYLENE Polipropilene
PPL	PPL	PPL	€ 140,00

Minimum order 300 pcs
 Ordine minimo 300 pz

PPL FINISHES / Finiture PPL



SAFETY, STRENGTH and DURABILITY TESTS
 Prove di sicurezza, resistenza e durata
 EN 1728:2012+AC2013
 EN 16139:2013 level 2

PACKING / Imballo



TECHNICAL DETAILS / Dettagli tecnici

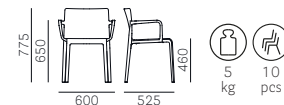

Volt 676



SEAT Sedile	BACK Schienale	FRAME Telaio	FABRIC Tessuto
C83+C89; C100+C101 C110+C122	C83+C89; C100+C101 C110+C122		€ 301,00
C90+C95	C90+C95	PPL	€ 301,00
D40+D44	D40+D44		€ 307,00

For fabrics see page 325
 Per i tessuti si veda a p. 325

PPL FINISHES / Finiture PPL



SAFETY, STRENGTH and DURABILITY TESTS
 Prove di sicurezza, resistenza e durata
 EN 1728:2012+AC2013
 EN 16139:2013 level 2

PACKING / Imballo



TECHNICAL DETAILS / Dettagli tecnici

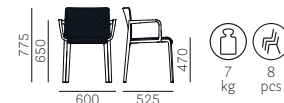

Volt 676/2



SEAT Sedile	BACK Schienale	FRAME Telaio	FABRIC Tessuto
C Excluding / Escluso C36+C39			€ 197,00
D40+D44			€ 206,00
G	PPL	PPL	€ 219,00
H Excluding / Escluso H140+H143			€ 199,00

For fabrics see page 325
Per i tessuti si veda a p. 325

PPL FINISHES / Finiture PPL

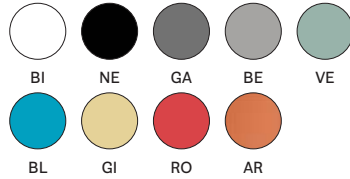

SAFETY, STRENGTH and DURABILITY TESTS
Prove di sicurezza, resistenza e durata
EN 1728:2012+AC2013
EN 16139:2013 level 2

PACKING / Imballo



TECHNICAL DETAILS / Dettagli tecnici

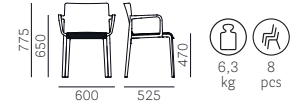

Volt 677



SEAT Sedile	BACK Schienale	FRAME Telaio	POLYPROPYLENE Polipropilene
PPL	PPL	PPL H660	€ 111,00

PPL FINISHES / Finiture PPL



SAFETY, STRENGTH and DURABILITY TESTS
Prove di sicurezza, resistenza e durata
EN 1728:2012+AC2013
EN 16139:2013 level 2

PACKING / Imballo



TECHNICAL DETAILS / Dettagli tecnici

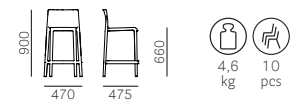

Volt 678



SEAT Sedile	BACK Schienale	FRAME Telaio	POLYPROPYLENE Polipropilene
PPL	PPL	PPL H765	€ 111,00

PPL FINISHES / Finiture PPL

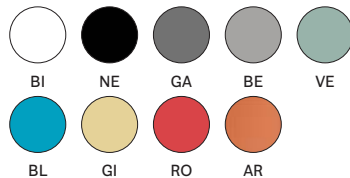

SAFETY, STRENGTH and DURABILITY TESTS
Prove di sicurezza, resistenza e durata
EN 1728:2012+AC2013
EN 16139:2013 level 2

PACKING / Imballo



TECHNICAL DETAILS / Dettagli tecnici



Volt 677/2



SEAT Sedile	BACK Schienale	FRAME Telaio	FABRIC Tessuto
C Excluding / Escluso C36+C39			€ 205,00
D40+D44			€ 212,00
G	PPL	PPL H680	€ 225,00
H Excluding / Escluso H140+H143			€ 207,00

For fabrics see page 325
Per i tessuti si veda a p. 325

PPL FINISHES / Finiture PPL

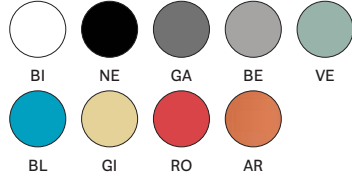

SAFETY, STRENGTH and DURABILITY TESTS
Prove di sicurezza, resistenza e durata
EN 1728:2012+AC2013
EN 16139:2013 level 2

PACKING / Imballo



TECHNICAL DETAILS / Dettagli tecnici

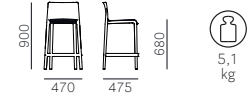

Volt 678/2



SEAT Sedile	BACK Schienale	FRAME Telaio	FABRIC Tessuto
C Excluding / Escluso C36+C39			€ 205,00
D40+D44			€ 212,00
G	PPL	PPL H785	€ 225,00
H Excluding / Escluso H140+H143			€ 207,00

For fabrics see page 325
Per i tessuti si veda a p. 325

PPL FINISHES / Finiture PPL

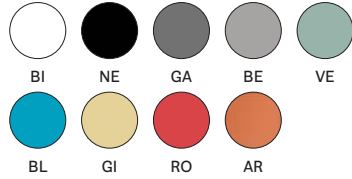

SAFETY, STRENGTH and DURABILITY TESTS
Prove di sicurezza, resistenza e durata
EN 1728:2012+AC2013
EN 16139:2013 level 2

PACKING / Imballo



TECHNICAL DETAILS / Dettagli tecnici

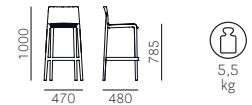

Volt HB 673



SEAT Sedile	BACK Schienale	FRAME Telaio	POLYPROPYLENE Polipropilene
PPL	PPL	PPL	€ 86,00

PPL FINISHES / Finiture PPL



SAFETY, STRENGTH and DURABILITY TESTS
Prove di sicurezza, resistenza e durata
EN 1728:2012+AC2013
EN 16139:2013 level 2

PACKING / Imballo



TECHNICAL DETAILS / Dettagli tecnici



Volt HB 673/2



SEAT Sedile	BACK Schienale	FRAME Telaio	FABRIC Tessuto
C Excluding / Escluso C36+C39			€ 185,00
D40+D44			€ 194,00
G	PPL	PPL	€ 207,00
H Excluding / Escluso H140+H143			€ 189,00

For fabrics see page 325
Per i tessuti si veda a p. 325

PPL FINISHES / Finiture PPL

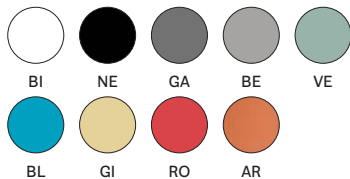

SAFETY, STRENGTH and DURABILITY TESTS
Prove di sicurezza, resistenza e durata
EN 1728:2012+AC2013
EN 16139:2013 level 2

PACKING / Imballo



TECHNICAL DETAILS / Dettagli tecnici

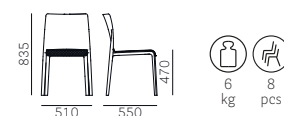

Volt HB 674



SEAT Sedile	BACK Schienale	FRAME Telaio	POLYPROPYLENE Polipropilene
PPL	PPL	PPL	€ 101,00

PPL FINISHES / Finiture PPL



SAFETY, STRENGTH and DURABILITY TESTS
Prove di sicurezza, resistenza e durata
EN 1728:2012+AC2013
EN 16139:2013 level 2

PACKING / Imballo



TECHNICAL DETAILS / Dettagli tecnici

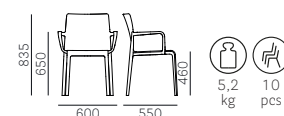

Volt HB 674/2



SEAT Sedile	BACK Schienale	FRAME Telaio	FABRIC Tessuto
C Excluding / Escluso C36+C39			€ 199,00
D40+D44			€ 208,00
G	PPL	PPL	€ 221,00
H Excluding / Escluso H140+H143			€ 203,00

For fabrics see page 325
Per i tessuti si veda a p. 325

PPL FINISHES / Finiture PPL

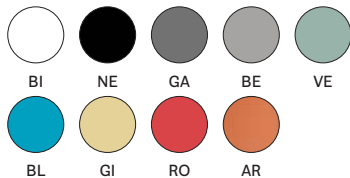

SAFETY, STRENGTH and DURABILITY TESTS
Prove di sicurezza, resistenza e durata
EN 1728:2012+AC2013
EN 16139:2013 level 2

PACKING / Imballo



TECHNICAL DETAILS / Dettagli tecnici

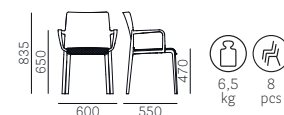

VAT NOT INCLUDED / Iva esclusa

Woody 495

Gas lift device
Alzata a gas



SEAT Sedile	FRAME Telaio	CHROMED Cromato	SATINIZED Satinato
RS-W	Ø 400 H640+780	€ 436,00	€ 461,00

FINISHES / Finiture



PACKING / Imballo

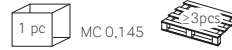

TECHNICAL DETAILS / Dettagli tecnici



SAFETY, STRENGTH and DURABILITY TESTS
Prove di sicurezza, resistenza e durata
EN 15373:2007

Woody 496



SEAT Sedile	FRAME Telaio	CHROMED Cromato	BRUSHED S/STEEL Inox satinato
RS-W	Ø 400 H770	€ 436,00	€ 436,00

FINISHES / Finiture



PACKING / Imballo

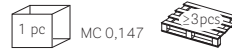

TECHNICAL DETAILS / Dettagli tecnici

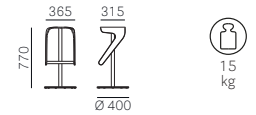

SAFETY, STRENGTH and DURABILITY TESTS
Prove di sicurezza, resistenza e durata
EN 15373:2007

Wow 320



SEAT Sedile	FRAME Telaio	FABRIC Tessuto
C	360x360 H480	€ 231,00
D120÷D123		€ 272,00
G		€ 342,00
H		€ 238,00

For fabrics see page 325
Per i tessuti si veda a p. 325

PACKING / Imballo



TECHNICAL DETAILS / Dettagli tecnici

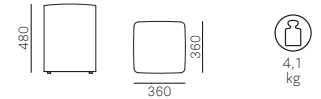

Wow 321



SEAT Sedile	FRAME Telaio	FABRIC Tessuto
C	910x360 H480	€ 406,00
D120÷D123		€ 506,00
G		€ 579,00
H		€ 420,00

For fabrics see page 325
Per i tessuti si veda a p. 325

PACKING / Imballo



TECHNICAL DETAILS / Dettagli tecnici

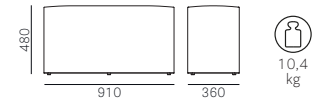

Wow 322



SEAT Sedile	FRAME Telaio	FABRIC Tessuto
C	Ø 400 H480	€ 224,00
D120÷D123		€ 259,00
G		€ 331,00
H		€ 233,00

For fabrics see page 325
Per i tessuti si veda a p. 325

PACKING / Imballo



TECHNICAL DETAILS / Dettagli tecnici

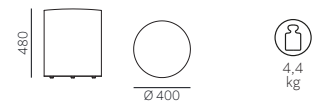

Wow 327



SEAT Sedile	FRAME Telaio	CHROMED Cromato	BRUSHED BRONZE Bronzo satinato	ANTIQUE BRASS Ottone anticato
C	Ø 400 H480	€ 312,00	€ 348,00	€ 348,00
D120÷D123		€ 348,00	€ 383,00	€ 383,00
G		€ 419,00	€ 454,00	€ 454,00
H		€ 322,00	€ 357,00	€ 357,00

For fabrics see page 325
Per i tessuti si veda a p. 325

PACKING / Imballo



TECHNICAL DETAILS / Dettagli tecnici

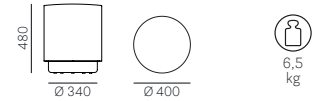

Wow 323



SEAT Sedile	FRAME Telaio	FABRIC Tessuto
C	Ø 650 H430	€ 385,00
D120÷D123		€ 470,00
G		€ 563,00
H		€ 400,00

For fabrics see page 325
Per i tessuti si veda a p. 325

PACKING / Imballo



TECHNICAL DETAILS / Dettagli tecnici

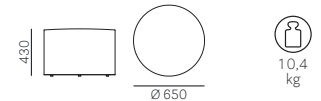

Wow 326



SEAT Sedile	FRAME Telaio	CHROMED Cromato	BRUSHED BRONZE Bronzo satinato	ANTIQUE BRASS Ottone anticato
C	Ø 650 H430	€ 524,00	€ 585,00	€ 585,00
D120÷D123		€ 610,00	€ 671,00	€ 671,00
G		€ 702,00	€ 764,00	€ 764,00
H		€ 539,00	€ 600,00	€ 600,00

For fabrics see page 325
Per i tessuti si veda a p. 325

PACKING / Imballo



TECHNICAL DETAILS / Dettagli tecnici

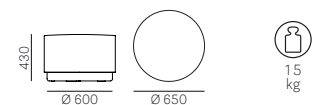

Wow 324



SEAT Sedile	FRAME Telaio	FABRIC Tessuto
C	600x600 H430	€ 389,00
D120+D123		€ 470,00
G		€ 569,00
H		€ 402,00

For fabrics see page 325
Per i tessuti si veda a p. 325

PACKING / Imballo



TECHNICAL DETAILS / Dettagli tecnici

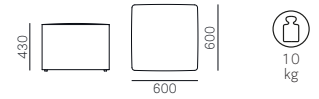

Wow 325



SEAT Sedile	FRAME Telaio	FABRIC Tessuto
C	Ø 850 H430	€ 565,00
D120+D123		€ 695,00
G		€ 803,00
H		€ 584,00

For fabrics see page 325
Per i tessuti si veda a p. 325

PACKING / Imballo



TECHNICAL DETAILS / Dettagli tecnici

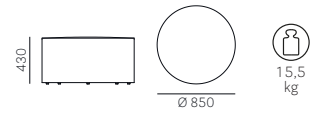

Wow 470



SEAT Sedile	FRAME Telaio	POLYETHYLENE Polietilene
PET	Ø 660	€ 188,00

PET FINISHES / Finiture PET



PACKING / Imballo



TECHNICAL DETAILS / Dettagli tecnici

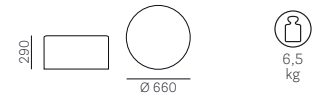

Wow 472



SEAT Sedile	FRAME Telaio	METHACRYLATE Metacrilato
	Ø 630	€ 173,00

Two-coloured top for WOW item 470
Ripiano bicolore per WOW art.470

ME FINISHES / Finiture ME



PACKING / Imballo



TECHNICAL DETAILS / Dettagli tecnici



Wow 470+473



SEAT Sedile	FRAME Telaio	POLYETHYLENE Polietilene
PET	Ø 600	€ 273,00

WOW item 470 + chromed base item 473
WOW art.470 + base cromata art. 473

PET FINISHES / Finiture PET



PACKING / Imballo



TECHNICAL DETAILS / Dettagli tecnici

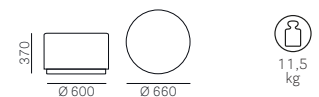

Wow 475

LUMINOUS
LUMINOSO



SEAT Sedile	FRAME Telaio	POLYETHYLENE Polietilene
PET	Ø 630	

English plug version: surcharge € 46,00 (item 475_UK)
Versione con presa britannica: supplemento € 46,00 (art. 475_UK)

PET FINISHES / Finiture PET



BI

PACKING / Imballo



TECHNICAL DETAILS / Dettagli tecnici

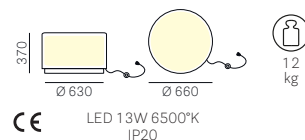

Wow 475E

LUMINOUS
LUMINOSO



SEAT Sedile	FRAME Telaio	POLYETHYLENE Polietilene
PET	Ø 630	

PET FINISHES / Finiture PET



BI

PACKING / Imballo



TECHNICAL DETAILS / Dettagli tecnici

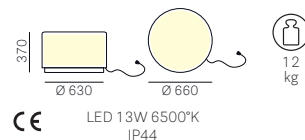

Wow 475L

LED



SEAT Sedile	FRAME Telaio	POLYETHYLENE Polietilene
PET	Ø 630	

PET FINISHES / Finiture PET



BI



LED RGB

With LED that change colours: red, yellow, green, violet, blue, light blue
Con LED che cambiano colore: rosso, giallo, verde, viola, blu, azzurro

PACKING / Imballo



TECHNICAL DETAILS / Dettagli tecnici

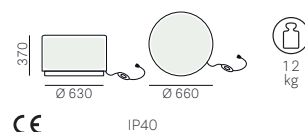

Wow 480



SEAT Sedile	FRAME Telaio	POLYETHYLENE Polietilene
PET	Ø 400	€ 119,00

PET FINISHES / Finiture PET



PACKING / Imballo



TECHNICAL DETAILS / Dettagli tecnici

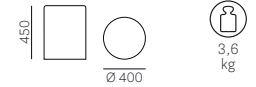

Wow 482



SEAT Sedile	FRAME Telaio	METHACRYLATE Metacrilato
	Ø 375	€ 68,00

Two-coloured top for WOW item 480
Ripiano bicolore per WOW art.480

ME FINISHES / Finiture ME



PACKING / Imballo



TECHNICAL DETAILS / Dettagli tecnici



Wow 480+483



SEAT Sedile	FRAME Telaio	POLYETHYLENE Polietilene
PET	Ø 340	€ 164,00

WOW item 480 + chromed base item 483
WOW art.480 + base cromata art.483

PET FINISHES / Finiture PET



PACKING / Imballo



TECHNICAL DETAILS / Dettagli tecnici

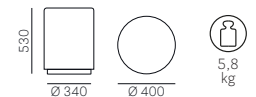

Wow 485

LUMINOUS
LUMINOSO



SEAT Sedile	FRAME Telaio	POLYETHYLENE Polietilene
PET	Ø 400	€ 231,00

English plug version: surcharge € 46,00 (item 485_UK)
Versione con presa britannica: supplemento € 46,00 (art. 485_UK)

PET FINISHES / Finiture PET



BI

PACKING / Imballo



TECHNICAL DETAILS / Dettagli tecnici

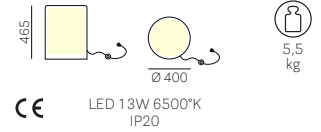

Wow 485E

LUMINOUS
LUMINOSO



SEAT Sedile	FRAME Telaio	POLYETHYLENE Polietilene
PET	Ø 400	€ 232,00

PET FINISHES / Finiture PET



BI

PACKING / Imballo



TECHNICAL DETAILS / Dettagli tecnici

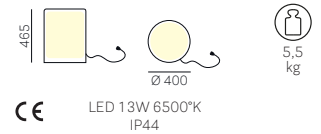

Wow 485L

LED



SEAT Sedile	FRAME Telaio	POLYETHYLENE Polietilene
PET	Ø 400	€ 371,00

PET FINISHES / Finiture PET



BI



LED RGB

With LED that change colours: red, yellow, green, violet, blue, light blue
Con LED che cambiano colore: rosso, giallo, verde, viola, blu, azzurro

PACKING / Imballo



TECHNICAL DETAILS / Dettagli tecnici

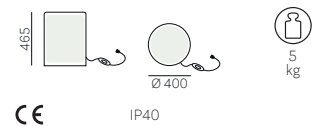

Wow 486

LUMINOUS
LUMINOSO



SEAT Sedile	FRAME Telaio	POLYETHYLENE Polietilene
	Ø 310	<p>€ 455,00 Methacrylate top included Con ripiano in metacrilato</p>

PET FINISHES / Finiture PET



BI

ME FINISHES / Finiture ME



OP

PACKING / Imballo



MC 0,087

TECHNICAL DETAILS / Dettagli tecnici

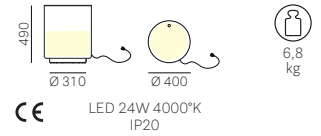

Young 420



SEAT Sedile	BACK Schienale	FRAME Telaio	OAK Rovere
RS-W-N1- GC-BI	RS-W-N1- GC-BI	RS-W-N1- GC-BI	<p>€ 346,00</p>

FINISHES / Finiture



RS

W

N1

GC

BI

PACKING / Imballo



MC 0,305

TECHNICAL DETAILS / Dettagli tecnici

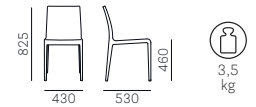

SAFETY, STRENGTH and DURABILITY TESTS
Prove di sicurezza, resistenza e durata
EN 1728:2000
ANSI BIFMA X5.1-2002

Young 420



SEAT Sedile	BACK Schienale	FRAME Telaio	OAK Rovere
BL2 AZ1 VE2 VE1 RB RA MO MC	BL2 AZ1 VE2 VE1 RB RA MO MC	BL2 AZ1 VE2 VE1 RB RA MO MC	<p>€ 362,00 Lacquered with visible grains Laccato a poro aperto</p>

FINISHES / Finiture



BL2

AZ1

VE2

VE1



RB



RA



MO



MC

PACKING / Imballo



MC 0,305

TECHNICAL DETAILS / Dettagli tecnici

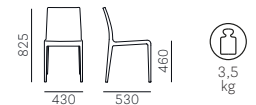

SAFETY, STRENGTH and DURABILITY TESTS
Prove di sicurezza, resistenza e durata
EN 1728:2000
ANSI BIFMA X5.1-2002

Young 420



SEAT Sedile	BACK Schienale	FRAME Telaio
V101- V102-V103	V101- V102-V103	V101- V102-V103

OAK
Rovere

€ 392,00
Vintage / Anticato

FINISHES / Finiture



V101 V102 V103

PACKING / Imballo



TECHNICAL DETAILS / Dettagli tecnici



SAFETY, STRENGTH and DURABILITY TESTS
Prove di sicurezza, resistenza e durata
EN 1728:2000
ANSI BIFMA X5.1-2002

Young 421



SEAT Sedile	BACK Schienale	FRAME Telaio
RS-W-N1- GC-BI	RS-W-N1- GC-BI	RS-W-N1- GC-BI

OAK
Rovere

€ 471,00

FINISHES / Finiture



RS W N1 GC BI

PACKING / Imballo



TECHNICAL DETAILS / Dettagli tecnici



SAFETY, STRENGTH and DURABILITY TESTS
Prove di sicurezza, resistenza e durata
EN 1728:2000

Young 421



SEAT Sedile	BACK Schienale	FRAME Telaio
BL2 AZ1 VE2 VE1 RB RA MO MC	BL2 AZ1 VE2 VE1 RB RA MO MC	BL2 AZ1 VE2 VE1 RB RA MO MC

OAK
Rovere

€ 488,00
Lacquered with visible grains
Laccato a poro aperto

FINISHES / Finiture



BL2 AZ1 VE2 VE1
RB RA MO MC

PACKING / Imballo



TECHNICAL DETAILS / Dettagli tecnici



SAFETY, STRENGTH and DURABILITY TESTS
Prove di sicurezza, resistenza e durata
EN 1728:2000



PRODUCT CERTIFIED
FOR LOW CHEMICAL
EMISSIONS:
UL COMGG
UL 2818



PRODUCT CERTIFIED
FOR LOW CHEMICAL
EMISSIONS:
UL COMGG
UL 2818

Young 421



SEAT Sedile	BACK Schienale	FRAME Telaio
V101- V102-V103	V101- V102-V103	V101- V102-V103

OAK
Rovere

€ 518,00
Vintage / Anticato

FINISHES / Finiture



V101 V102 V103

PACKING / Imballo



TECHNICAL DETAILS / Dettagli tecnici

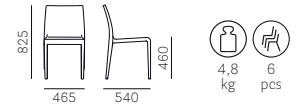

SAFETY, STRENGTH and DURABILITY TESTS
Prove di sicurezza, resistenza e durata
EN 1728:2000



Young 423



SEAT Sedile	BACK Schienale	FRAME Telaio
C Excluding / Escluso C36+C39	C	RS-W-N1- GC-BI
G	G	
H Excluding / Escluso H140+H143	H	
P	P	

OAK
Rovere

€ 491,00

€ 557,00

€ 497,00

€ 592,00

For fabrics see page 325
Per i tessuti si veda a p. 325

FINISHES / Finiture



RS W N1 GC BI

PACKING / Imballo



TECHNICAL DETAILS / Dettagli tecnici

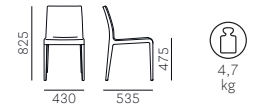

Young 424



SEAT Sedile	BACK Schienale	FRAME Telaio
C Excluding / Escluso C36+C39	C	RS-W-N1- GC-BI
G	G	
H Excluding / Escluso H140+H143	H	
P	P	

OAK
Rovere

€ 615,00

€ 682,00

€ 622,00

€ 717,00

For fabrics see page 325
Per i tessuti si veda a p. 325

FINISHES / Finiture



RS W N1 GC BI

PACKING / Imballo



TECHNICAL DETAILS / Dettagli tecnici



Young 426



SEAT Sedile	BACK Schienale	FRAME Telaio	OAK Rovere
RS-W-N1- GC-BI	RS-W-N1- GC-BI	H750	€ 474,00

FINISHES / Finiture



PACKING / Imballo



TECHNICAL DETAILS / Dettagli tecnici

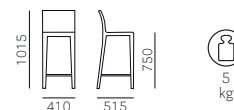

Young 426



SEAT Sedile	BACK Schienale	FRAME Telaio	OAK Rovere
BL2 AZ1 VE2 VE1 RB RA MO MC	BL2 AZ1 VE2 VE1 RB RA MO MC	H750	€ 489,00 Lacquered with visible grains Laccato a poro aperto

FINISHES / Finiture

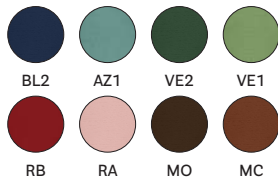

PACKING / Imballo



TECHNICAL DETAILS / Dettagli tecnici

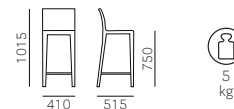

Young 426



SEAT Sedile	BACK Schienale	FRAME Telaio	OAK Rovere
V101- V102-V103	V101- V102-V103	H750	€ 519,00 Vintage / Anticato

FINISHES / Finiture



PACKING / Imballo



TECHNICAL DETAILS / Dettagli tecnici

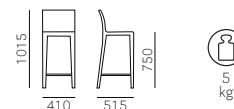

Young 428



SEAT Sedile	BACK Schienale	FRAME Telaio	OAK Rovere
C Excluding / Escluso C36+C39	C	H770	€ 619,00
G	G		€ 676,00
H Excluding / Escluso H140+H143	H		€ 635,00
P	P		€ 718,00

For fabrics see page 325
Per i tessuti si veda a p. 325

FINISHES / Finiture



PACKING / Imballo



TECHNICAL DETAILS / Dettagli tecnici

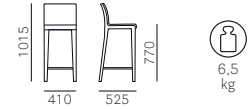

Zippo ZIP2P/100

Low back
Schienale basso



SEAT Sedile	BACK Schienale	FRAME Telaio	WHITE/BLACK/SILVER POWDER COATED Verniciato bianco/nero/alluminio
C Excluding / Escluso C36+C39	C	Ø 16	€ 2.329,00
D40+D44	D40+D44		€ 2.621,00
G	G		€ 3.049,00
H Excluding / Escluso H140+H143	H		€ 2.373,00

Sound absorption measurement: 100 Hz = 1,46 (EN ISO 354:2003)
Coefficiente assorbimento acustico: 100 Hz = 1,46 (EN ISO 354:2003)

FINISHES / Finiture



PACKING / Imballo



TECHNICAL DETAILS / Dettagli tecnici

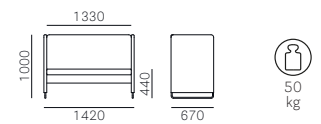

Zippo ZIP2P/140

High back
Schienale alto



SEAT Sedile	BACK Schienale	FRAME Telaio	WHITE/BLACK/SILVER POWDER COATED Verniciato bianco/nero/alluminio
C Excluding / Escluso C36+C39	C	Ø 16	€ 2.584,00
D40+D44	D40+D44		€ 2.918,00
G	G		€ 3.365,00
H Excluding / Escluso H140+H143	H		€ 2.629,00

Sound absorption measurement: 100 Hz = 1,46 (EN ISO 354:2003)
Coefficiente assorbimento acustico: 100 Hz = 1,46 (EN ISO 354:2003)

FINISHES / Finiture



PACKING / Imballo



TECHNICAL DETAILS / Dettagli tecnici

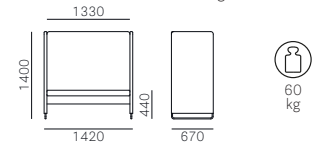

Zippo ZIP1P/100

Low back
Schienale basso

SEAT Sedile	BACK Schienale	FRAME Telaio	WHITE/BLACK/SILVER POWDER COATED Verniciato bianco/nero/alluminio
C Excluding / Escluso C36+C39	C	Ø 16	€ 2.034,00
D40+D44	D40+D44		€ 2.257,00
G	G		€ 2.610,00
H Excluding / Escluso H140+H143	H		€ 2.069,00

Sound absorption measurement: 100 Hz = 1,46 (EN ISO 354:2003)
Coefficiente assorbimento acustico: 100 Hz = 1,46 (EN ISO 354:2003)

FINISHES / Finiture

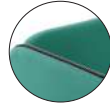

Zip colour matched with frame finish
Colore della zip in tinta col telaio
For fabrics see page 325
Per i tessuti si veda a p. 325

PACKING / Imballo



TECHNICAL DETAILS / Dettagli tecnici

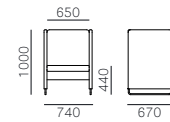

40 kg

Zippo ZIP1P/140

High back
Schienale alto

SEAT Sedile	BACK Schienale	FRAME Telaio	WHITE/BLACK/SILVER POWDER COATED Verniciato bianco/nero/alluminio
C Excluding / Escluso C36+C39	C	Ø 16	€ 2.279,00
D40+D44	D40+D44		€ 2.541,00
G	G		€ 2.968,00
H Excluding / Escluso H140+H143	H		€ 2.320,00

Sound absorption measurement: 100 Hz = 1,46 (EN ISO 354:2003)
Coefficiente assorbimento acustico: 100 Hz = 1,46 (EN ISO 354:2003)

FINISHES / Finiture

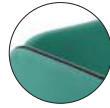

Zip colour matched with frame finish
Colore della zip in tinta col telaio
For fabrics see page 325
Per i tessuti si veda a p. 325

PACKING / Imballo



TECHNICAL DETAILS / Dettagli tecnici

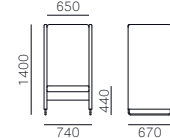

48 kg

Zippo ZIPL1P

LOUNGE



SEAT Sedile	BACK Schienale	FRAME Telaio	WHITE/BLACK/SILVER POWDER COATED Verniciato bianco/nero/alluminio
C Excluding / Escluso C36+C39	C	Ø 16	€ 1.867,00
D40+D44	D40+D44		€ 2.019,00
G	G		€ 2.251,00
H Excluding / Escluso H140+H143	H		€ 1.921,00

Sound absorption measurement: 100 Hz = 1,46 (EN ISO 354:2003)
Coefficiente assorbimento acustico: 100 Hz = 1,46 (EN ISO 354:2003)

FINISHES / Finiture

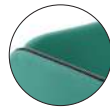

Zip colour matched with frame finish
Colore della zip in tinta col telaio
For fabrics see page 325
Per i tessuti si veda a p. 325

PACKING / Imballo



TECHNICAL DETAILS / Dettagli tecnici

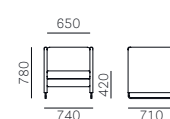

34 kg

3001

Cushion
Cuscino



FABRIC
Tessuto

D22+D26
D80+D89
D100+D105
D110+D114
D130

For fabrics see page 325
Per i tessuti si veda a p. 325

PRICE
Prezzo

€ 130,00

PACKING / Imballo



TECHNICAL DETAILS / Dettagli tecnici

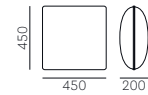

3002

Cushion
Cuscino



FABRIC
Tessuto

D22+D26
D80+D89
D100+D105
D110+D114
D130

For fabrics see page 325
Per i tessuti si veda a p. 325

PRICE
Prezzo

€ 130,00

PACKING / Imballo



TECHNICAL DETAILS / Dettagli tecnici

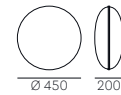

3004

Cushion
Cuscino



FABRIC
Tessuto

D22+D26
D80+D89
D100+D105
D110+D114
D130

For fabrics see page 325
Per i tessuti si veda a p. 325

PRICE
Prezzo

€ 98,00

PACKING / Imballo



TECHNICAL DETAILS / Dettagli tecnici



3005

Cushion
Cuscino



FABRIC Tessuto	PRICE Prezzo
D22+D26 D80+D89 D100+D105 D110+D114 D130	€ 98,00

For fabrics see page 325
Per i tessuti si veda a p. 325

PACKING / Imballo



TECHNICAL DETAILS / Dettagli tecnici



1,1
kg

3012

Cushion
Cuscino



FABRIC Tessuto	PRICE Prezzo
C110+C122 C210+C217	€ 137,00
D120+D123	€ 156,00
E	€ 182,00
G *	€ 182,00
H120+H127 H140+H143	€ 143,00
N01+N08 N30+N38	€ 195,00

* Excluding / Escluso G07, G100+G102, G150+G156, G180+G185, G200+G206

For fabrics see page 325
Per i tessuti si veda a p. 325

PACKING / Imballo



TECHNICAL DETAILS / Dettagli tecnici



0,6
kg

3013

Cushion
Cuscino



FABRIC Tessuto	PRICE Prezzo
C110+C122 C210+C217	€ 111,00
D120+D123	€ 130,00
E	€ 163,00
G *	€ 163,00
H120+H127 H140+H143	€ 117,00
N01+N08 N30+N38	€ 176,00

* Excluding / Escluso G07, G100+G102, G150+G156, G180+G185, G200+G206

For fabrics see page 325
Per i tessuti si veda a p. 325

PACKING / Imballo



TECHNICAL DETAILS / Dettagli tecnici

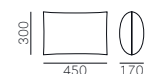

0,6
kg

Protective covers















Coperture protettive

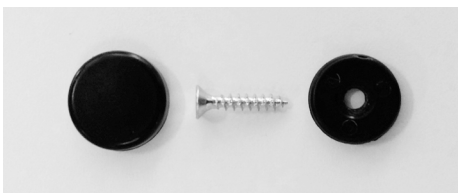

CODE Codice	RACOMMENDED FOR THE FOLLOWING ITEMS: Raccomandate per i seguenti articoli:	PACKAGING Imballo	PVC PVC
COVER001	<p>Arki-Sofa: AS0010, AS0111, AS0012, AS0040</p> <p>Reva, Reva Twist: REVA_P, REVA/2_P</p> <p>Reva Cocoon: RVC010, RVC012</p>	 MC 0,056	€ 195,00
COVER002	<p>Reva Cocoon: RVC011, RVC013, RVC014</p>	 MC 0,056	€ 208,00
COVER003	<p>Nolita Sofa: Any model / Tutti i modelli</p>	 MC 0,056	€ 208,00
COVER004	<p>Arki-Sofa: AS0030, AS0031</p> <p>Reva Cocoon: RVC033, RVC034</p>	 MC 0,056	€ 234,00
COVER005	<p>Arki-Sofa: AS0020, AS0121, AS0022</p> <p>Reva, Reva Twist: REVA_D, REVA/2_D</p> <p>Reva Cocoon: RVC022</p>	 MC 0,056	€ 208,00
COVER006	<p>Reva Cocoon: RVC021, RVC023, RVC024, RVC025, RVC026, RVC027</p>	 MC 0,056	€ 260,00

Glides for wooden seating

Piedini per sedute in legno

CODE Codice	RACCOMENDED FOR THE FOLLOWING FLOORS: Raccomandati per i seguenti pavimenti:	PACKAGING Imballo	FELT Feltro	PLASTIC Plastica
 <p style="text-align: center;">FLT</p>	<p>Wood, ceramic and marble Legno, ceramica e marmo</p>	 MC 0,003  0,15 kg	<p>€ 43,00 (100 pcs/pz)</p> <p>Please mention the seating item code Si prega di specificare il codice della seduta</p>	
 <p style="text-align: center;">PIEDINO/15_100</p>	<p>Wood, ceramic and marble Legno, ceramica e marmo</p>	 MC 0,003  0,25 kg	<p>€ 72,00 (100 pcs/pz)</p> <p>to be ordered separately da ordinare separatamente</p>	
 <p style="text-align: center;">PIEDINO/15.1_100</p>		 MC 0,003  0,15 kg	<p>€ 51,00 (100 pcs/pz)</p> <p>to be ordered separately da ordinare separatamente</p>	
 <p style="text-align: center;">PIEDINO/17_100</p>	<p>Moquette, carpets, concrete and metal Moquette, tappeti, cemento e metallo</p>	 MC 0,003  0,25 kg		<p>€ 51,00 (100 pcs/pz)</p> <p>to be ordered separately da ordinare separatamente</p> <p>€ 12,00</p> <p>Upcharge each seating for preassembled glide Supplemento a seduta per piedino premontato</p>
 <p style="text-align: center;">PIEDINO/17.1_100</p>		 MC 0,003  0,15 kg		<p>€ 29,00 (100 pcs/pz)</p> <p>to be ordered separately da ordinare separatamente</p>

690/PIEDINO.POM_40

PLASTIC GLIDE
Piedino in materiale plastico



€ 33,00

(40 pcs/pz)

Suitable for moquette, carpets, linoleum or similar
Adatto per moquette, tappeti, linoleum o simili

For chairs/armchairs/pouf / Per sedie/poltrone/pouf
Ester (691, 690, 693)

TECHNICAL DETAILS / Dettagli tecnici

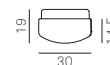

690/PIEDINO.FLT_40

PLASTIC GLIDE AND FELT
Piedino in materiale plastico e feltro



€ 33,00

(40 pcs/pz)

Suitable for wood, ceramic, marble or similar
Adatto per legno, ceramica, marmo o simili

For chairs/armchairs/pouf / Per sedie/poltrone/pouf
Ester (691, 690, 693)

TECHNICAL DETAILS / Dettagli tecnici

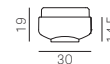

VAT NOT INCLUDED / Iva esclusa

MINIATURES_A

Miniature



POLYCARBONATE AND POLYPROPYLENE Policarbonato e polipropilene

€ 69,00

3pcs armchair / 3pz poltrona PASHA 660
(BI, NE, TR)



3pcs armchair / 3pz poltrona PLUS 630
(GA, SA, BI)



PACKING / Imballo



TECHNICAL DETAILS / Dettagli tecnici

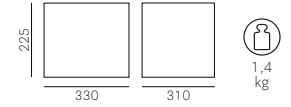

MINIATURES_315_640

Miniature



POLYCARBONATE AND POLYPROPYLENE Policarbonato e polipropilene

€ 69,00

3pcs armchair / 3pz poltrona ARA 315
(BI, BL, GC)



3pcs chair / 3pz sedia BLITZ 640
(TR, SA, RT)



PACKING / Imballo



TECHNICAL DETAILS / Dettagli tecnici

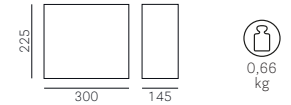

MINIATURES_260_A

Miniature



POLYPROPYLENE
Polipropilene

€ 29,00

3pcs chair / 3pz sedia DOME 260
(Bl, NE, VE)



PACKING / Imballo



Package colour: petroleum blue
Colore confezione: petrolio

TECHNICAL DETAILS / Dettagli tecnici

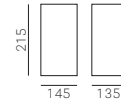

MINIATURES_260_B

Miniature



POLYPROPYLENE
Polipropilene

€ 29,00

3pcs chair / 3pz sedia DOME 260
(Bl, NE, VE)



PACKING / Imballo



Package colour: light blue
Colore confezione: azzurro

TECHNICAL DETAILS / Dettagli tecnici

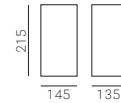

MINIATURES_260_C

Miniature



POLYPROPYLENE
Polipropilene

€ 29,00

3pcs chair / 3pz sedia DOME 260
(Bl, NE, VE)



PACKING / Imballo



Package colour: peach
Colore confezione: pesca

TECHNICAL DETAILS / Dettagli tecnici

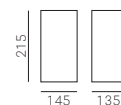

Finishes / Finiture

Lacquered wood with visible grains / Legno laccato a poro aperto

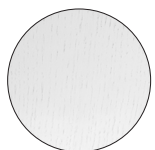

BI
White
Bianco

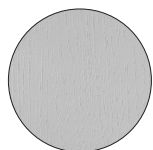

GC
Light grey
Grigio chiaro

PANTONE 400 U



AN
Black
Nero

PANTONE Black U



BL2
Dark blue
Blu scuro

PANTONE 539 U

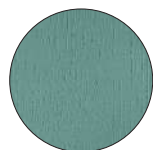

AZ1
Light blue
Azzurro

PANTONE 5503 U

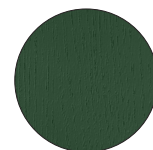

VE2
Dark green
Verde scuro

PANTONE 342 U

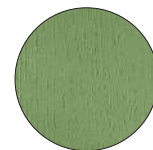

VE1
Light green
Verde chiaro

PANTONE 556 U

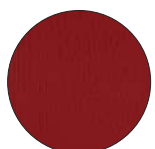

RB
Ruby red
Rosso rubino

PANTONE 1805 U

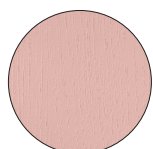

RA
Pink
Rosa

PANTONE 693 U



MO
Mahogany
Mogano

PANTONE 7603 U

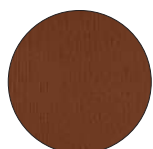

MC
Cognac
Cognac

PANTONE 1675 U

Colours are indicative. Pedrali reserves the right to modify or upgrade the product without prior notice.
I colori sono indicativi. Pedrali si riserva la facoltà di apportare modifiche o migliorie senza alcun preavviso.

Finishes / Finiture

Steel and stainless steel / Acciaio e acciaio inox

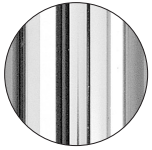

CR
Chromed steel
Acciaio cromato

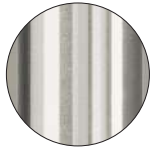

ST
Satinized steel
Acciaio satinato



CO
Matt chromed steel
Acciaio cromato opaco

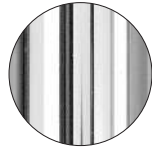

LU
Polished s/steel
Acciaio inox lucidato

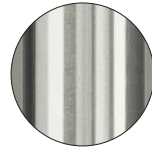

AC
Brushed s/steel
Acciaio inox satinato

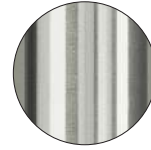

AC 316
Brushed s/steel AISI 316
for outdoor
Acciaio inox AISI 316 per
esterno



BS
Antique bronze steel
Acciaio bronzo anticato



OA
Antique brass steel
Acciaio ottone anticato

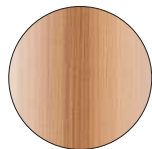

RM
Antique copper steel
Acciaio rame anticato



TN
Titanium steel
Acciaio finitura titanio

Gold lacquered / Laccato oro



VOR

Nickel / Nichel

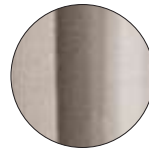

AS
Brushed nickel
Nichel satinato

Aluminium / Alluminio



LU
Polished aluminium
Alluminio lucidato

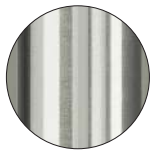

AS
Satinized aluminium
Alluminio satinato

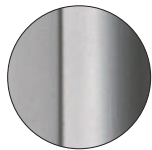

AA
Anodized aluminium
Alluminio anodizzato



TN
Titanium
Titanio

Colours are indicative. Pedrali reserves the right to modify or upgrade the product without prior notice.
I colori sono indicativi. Pedrali si riserva la facoltà di apportare modifiche o migliorie senza alcun preavviso.

Indoor finishes / Finiture per interno

Powder coated cast-iron, steel and aluminium / Ghisa, acciaio e alluminio verniciato



BI100
White,
textured-matt finish
Bianco,
finitura goffrata-opaca



BI200
White,
textured-matt finish
Bianco,
finitura goffrata-opaca

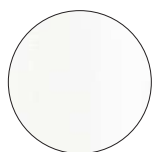

BI300
White,
smooth-matt finish
Bianco,
finitura liscia-opaca

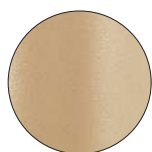

SA100
Sand,
textured-matt finish
Sabbia,
finitura goffrata-opaca



SA200
Sand,
textured-matt finish
Sabbia,
finitura goffrata-opaca

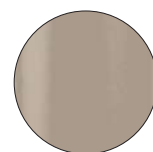

SA300
Sand,
hammered-glossy finish
Sabbia,
finitura bucciata-lucida

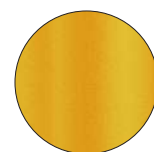

GI100
Yellow,
textured-matt finish
Giallo,
finitura goffrata-opaca

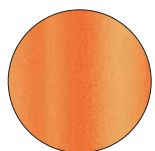

AR200
Orange,
textured-matt finish
Arancio,
finitura goffrata-opaca

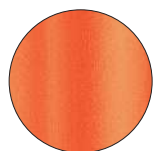

AR500
Orange,
textured-matt finish
Arancio,
finitura goffrata-opaca

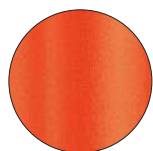

AR400
Orange,
textured-matt finish
Arancio,
finitura goffrata-opaca

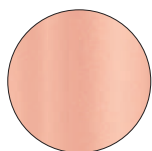

RA100
Pink,
textured-matt finish
Rosa,
finitura goffrata-opaca

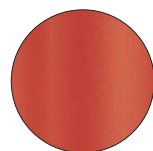

RO400
Red,
textured-matt finish
Rosso,
finitura goffrata-opaca

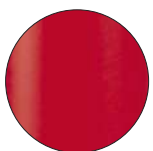

RO200
Red,
textured-matt finish
Rosso,
finitura goffrata-opaca

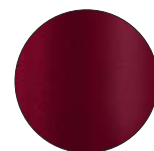

RO300
Red,
textured-matt finish
Rosso,
finitura goffrata-opaca

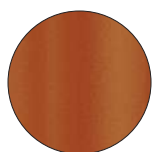

TE
Terracotta,
textured-matt finish
Terracotta,
finitura goffrata-opaca



RU
Rust,
textured-matt finish
Ruggine,
finitura goffrata-opaca



MG
Brown,
textured-matt finish
Marrone,
finitura goffrata-opaca

Colours are indicative. Pedrali reserves the right to modify or upgrade the product without prior notice.
I colori sono indicativi. Pedrali si riserva la facoltà di apportare modifiche o migliorie senza alcun preavviso.

Indoor finishes / Finiture per interno

Powder coated cast-iron, steel and aluminium / Ghisa, acciaio e alluminio verniciato

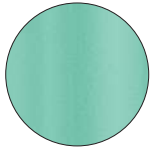

AZ100
Light blue,
textured-matt finish
Azzurro,
finitura goffrata-opaca

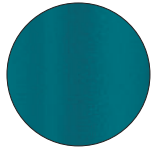

BL500
Blue,
textured-matt finish
Blu,
finitura goffrata-opaca

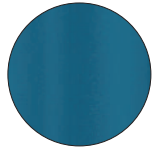

BL300
Blue,
textured-matt finish
Blu,
finitura goffrata-opaca



BL400
Blue,
textured-matt finish
Blu,
finitura goffrata-opaca

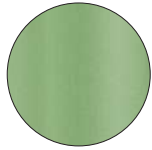

VE100
Sage green,
textured-matt finish
Verde salvia,
finitura goffrata-opaca



VE600
Green,
textured-matt finish
Verde,
finitura goffrata-opaca



VE300
Forest green soft-touch,
smooth-matt finish
Verde bosco soft-touch,
finitura liscia-opaca



6005
Green,
smooth-glossy finish
Verde,
finitura liscia-lucida

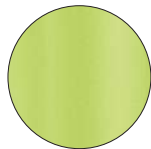

VE400
Green,
textured-matt finish
Verde,
finitura goffrata-opaca

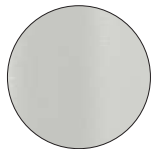

BE100
Beige,
textured-matt finish
Beige,
finitura goffrata-opaca



BE200
Beige,
textured-matt finish
Beige,
finitura goffrata-opaca

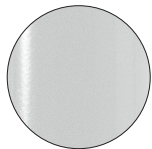

AL
Aluminium,
smooth-glossy finish
Alluminio,
finitura liscia-lucida

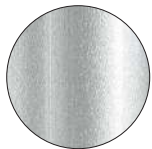

9007
Aluminium,
smooth-matt finish
Alluminio,
finitura liscia-opaca



AG
Aluminium,
textured-matt finish
Alluminio,
finitura goffrata-opaca



GA
Anthracite grey,
textured-matt finish
Grigio antracite,
finitura goffrata-opaca



GN
Natural grey,
textured-matt finish
Grigio naturale,
finitura goffrata-opaca



_NERO
Black,
hammered-matt finish
Nero,
finitura bucciata-opaca

Colours are indicative. Pedrali reserves the right to modify or upgrade the product without prior notice.
I colori sono indicativi. Pedrali si riserva la facoltà di apportare modifiche o migliorie senza alcun preavviso.

Outdoor finishes / Finiture per esterno



Powder coated cast-iron, steel and aluminium / Ghisa, acciaio e alluminio verniciato

BI100E White, textured-matt finish Bianco, finitura goffrata-opaca	BI200E White, textured-matt finish Bianco, finitura goffrata-opaca	BI300E White, smooth-matt finish Bianco, finitura liscia-opaca	SA100E Sand, textured-matt finish Sabbia, finitura goffrata-opaca	SA200E Sand, textured-matt finish Sabbia, finitura goffrata-opaca	GI100E Yellow, textured-matt finish Giallo, finitura goffrata-opaca	AR200E Orange, textured-matt finish Arancio, finitura goffrata-opaca
AR500E Orange, textured-matt finish Arancio, finitura goffrata-opaca	AR400E Orange, textured-matt finish Arancio, finitura goffrata-opaca	RA100E Pink, textured-matt finish Rosa, finitura goffrata-opaca	RO400E Red, textured-matt finish Rosso, finitura goffrata-opaca	RO200E Red, textured-matt finish Rosso, finitura goffrata-opaca	TEE Terracotta, textured-matt finish Terracotta, finitura goffrata-opaca	RUE Rust, textured-matt finish Ruggine, finitura goffrata-opaca
MGE Brown, textured-matt finish Marrone, finitura goffrata-opaca	AZ100E Light blue, textured-matt finish Azzurro, finitura goffrata-opaca	BL500E Blue, textured-matt finish Blu, finitura goffrata-opaca	BL300E Blue, textured-matt finish Blu, finitura goffrata-opaca	BL400E Blue, textured-matt finish Blu, finitura goffrata-opaca	VE100E Sage green, textured-matt finish Verde salvia, finitura goffrata-opaca	VE600E Green, textured-matt finish Verde, finitura goffrata-opaca
VE300E Forest green soft-touch, smooth-matt finish Verde bosco soft-touch, finitura liscia-opaca	6005E Green, smooth-glossy finish Verde, finitura liscia-lucida	BE100E Beige, textured-matt finish Beige, finitura goffrata-opaca	BE200E Beige, textured-matt finish Beige, finitura goffrata-opaca	ALE Aluminium, smooth-glossy finish Alluminio, finitura liscia-lucida	9007E Aluminium, smooth-matt finish Alluminio, finitura liscia-opaca	AGE Aluminium, textured-matt finish Alluminio, finitura goffrata-opaca
GAE Anthracite grey, textured-matt finish Grigio antracite, finitura goffrata-opaca	GNE Natural grey, textured-matt finish Grigio naturale, finitura goffrata-opaca	NPE Black, textured-matt finish Nero, finitura goffrata-opaca				

Colours are indicative. Pedrali reserves the right to modify or upgrade the product without prior notice.
I colori sono indicativi. Pedrali si riserva la facoltà di apportare modifiche o migliorie senza alcun preavviso.

Category B

Nylon / Nylon

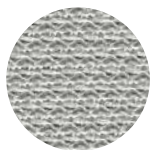

B01

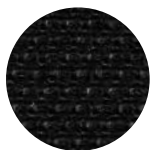

B02

For Island item 795-796-797
Per Island art. 795-796-797

Category C

Fabric / Tessuto



C36



C37

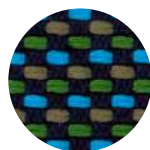

C38

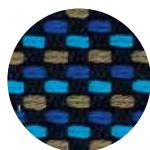

C39

For Arki-Stool, Babila XL, Ikon low stool, Noa, Tweet, Wow, Buddy and the following cushions only:
Social Plus, Blitz, Buddy, Queen, Pasha, Gliss and Ikon bench.
Solo per Arki-Stool, Babila XL, Ikon low stool, Noa, Tweet, Wow, Buddy e per i seguenti cuscini:
Social Plus, Blitz, Buddy, Queen, Pasha, Gliss e Ikon bench

Fire retardant fabric / Tessuto ignifugo

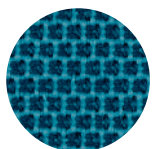

C83

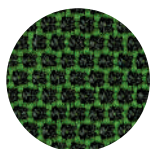

C84

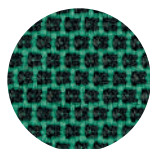

C88

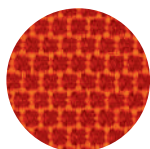

C85

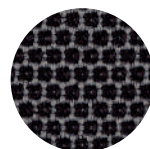

C86

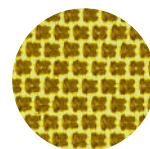

C87

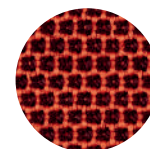

C89

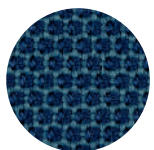

C100

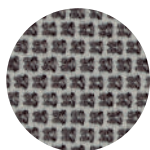

C101

- **FLAME RESISTANCE / RESISTENZA AL FUOCO**
BS EN 1021 1&2
BS EN 1021-1
ÖNORM A3800-1
US CA TB 117-2013



Fire retardant fabric / Tessuto ignifugo

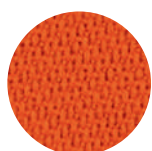

C110

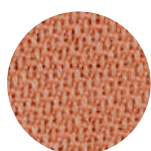

C111

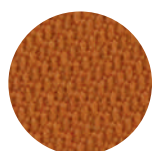

C112

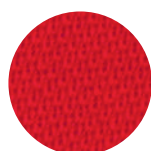

C113

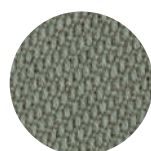

C114

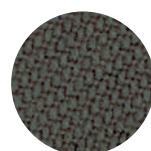

C115



C116



C117

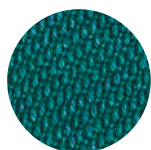

C118

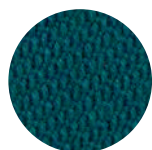

C119

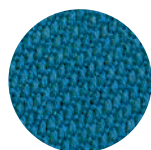

C120

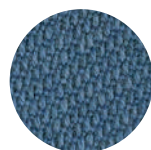

C121

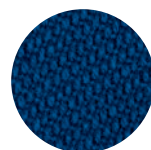

C122

• COLLECTION / COLLEZIONE
 **svensson** - SEMI

• FLAME RESISTANCE / RESISTENZA AL FUOCO
BS 5852 Crib 5
EN ISO 1021 Part 1&2
IMO FTP Code 2010: Part 8
UNI 9175 Classe 1 IM
US CA TB 117-2013



Fire retardant fabric / Tessuto ignifugo

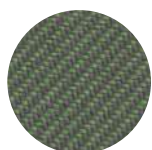

C210



C211



C212



C213



C214



C215



C216

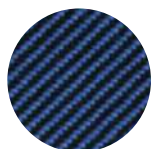

C217

• COLLECTION / COLLEZIONE
kvadrat - RELATE
DESIGNER Patricia Urquiola

• FLAME RESISTANCE / RESISTENZA AL FUOCO
AS/NZS 3837, class 2
BS 5852 Crib 5
BS 5852 Part 1 with treatment
DIN 4102 B1
EN 1021-1/2
IMO FTP Code 2010: Part 8
NF D60-013
NF P92 507 M1
NFPA 701
ÖNORM B1/Q1
SN 198 898 5.2
UNI 9175 Classe 1 IM
UNI 9177 Classe 1
US CA TB 117-2013

Colours are indicative. Pedrali reserves the right to modify or upgrade the product without prior notice.
I colori sono indicativi. Pedrali si riserva la facoltà di apportare modifiche o migliorie senza alcun preavviso.

Fire retardant simil leather / Finta pelle ignifuga



C18

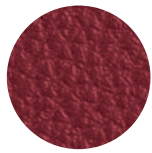

C11

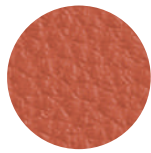

C12

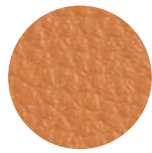

C13

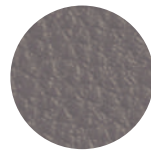

C15

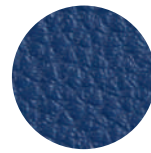

C10

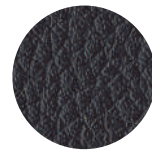

C17



C14



C21



C20



C22

- **FLAME RESISTANCE / RESISTENZA AL FUOCO**
 B2 (DIN 4102)
 BS 5852 Crib 5
 EN 1021.1-2
 EN 13501-1 - Cs3do
 FAR 25853 App F Part 1
 IMO RESOLUTION A.652
 NF D60-013 - AM 18
 NFP 92503 M1
 NY/NJ - Port Authority
 UFAC Fabric Class 1
 German fire standard B1 (except C12 and C22)
 US CA TB 117-2013
 US CA TB 133

Fire retardant simil leather / Finta pelle ignifuga



C130



C131



C132

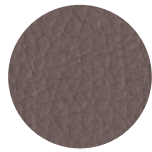

C133

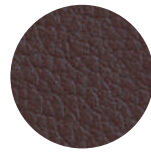

C134

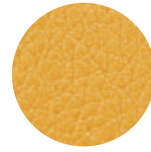

C135

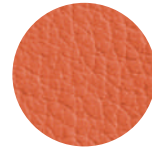

C136

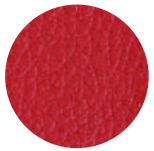

C137

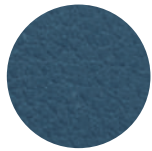

C138

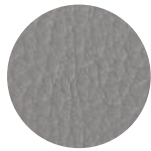

C139



C140



C141

- **FLAME RESISTANCE / RESISTENZA AL FUOCO**
 BS 5852-1 match test
 EN 1021 Part 1-2
 UNI 9175 Classe 1 IM
 US CA TB 117-2013



Fire retardant simil leather / Finta pelle ignifuga

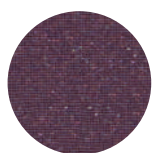

C60

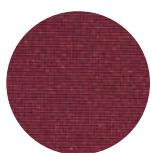

C61

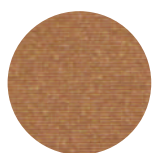

C62

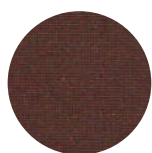

C63

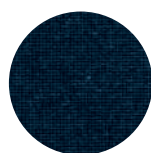

C64



C90



C94



C95

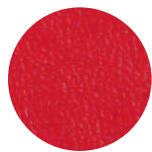

C92

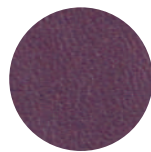

C91

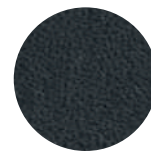

C93

- **FLAME RESISTANCE / RESISTENZA AL FUOCO**
BS 5852-1 Part 1
EN 1021-2
IMO RESOLUTION A.652 (16): 1989
UNI 9175 Classe 1 IM
US CA TB 117-2013

Category D



Fire retardant fabric / Tessuto ignifugo

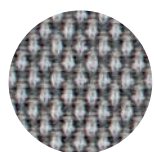

D40



D41

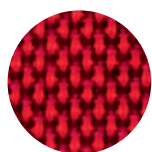

D42

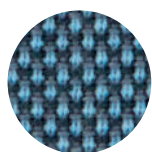

D43

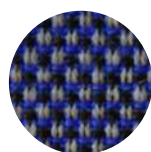

D44

- **FLAME RESISTANCE / RESISTENZA AL FUOCO**
BS EN 1021 1&2
BS 5852 Part 1 0, 1
UNI 9175 Classe 1 IM
US CA TB 117-2013

Fabric / Tessuto



D120



D121



D122



D123

- **FLAME RESISTANCE / RESISTENZA AL FUOCO**
BS 5852 Part 1
US CA TB 117-2013

Colours are indicative. Pedrali reserves the right to modify or upgrade the product without prior notice.
I colori sono indicativi. Pedrali si riserva la facoltà di apportare modifiche o migliorie senza alcun preavviso.



Fabric / Tessuto



D22

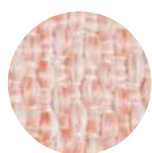

D23



D24



D25



D26

• COLLECTION / COLLEZIONE
PEDRALI - BREZZA



Fabric / Tessuto

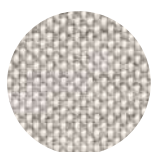

D80

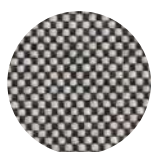

D81

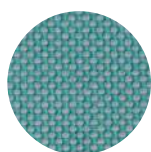

D82



D83

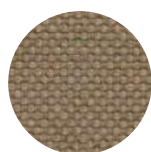

D84

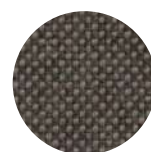

D85

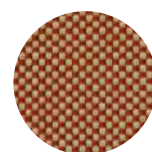

D86

• COLLECTION / COLLEZIONE
PEDRALI - FLORIDA

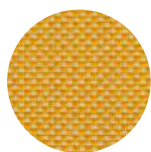

D87



D88

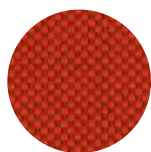

D89



Fabric / Tessuto

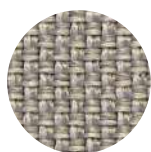

D100

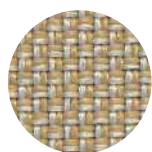

D101

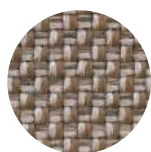

D105

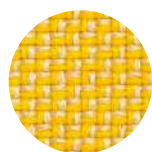

D102



D103

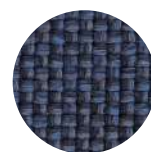

D104

• COLLECTION / COLLEZIONE
PEDRALI - ZEFIRO



Fabric / Tessuto



D110



D111



D112



D113

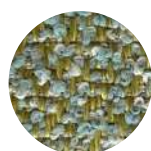

D114

• COLLECTION / COLLEZIONE
PEDRALI - SAND



Fabric / Tessuto

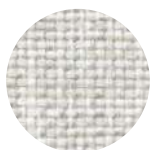

D130

Category E

Velvet / Velluto



E01



E06



E02



E07



E08

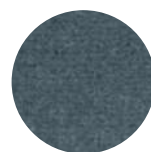

E04

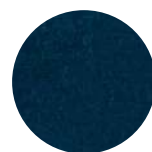

E03

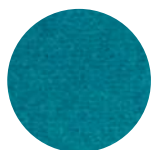

E05



E09

• COLLECTION / COLLEZIONE
DEDAR - ADAMO & EVA

Colours are indicative. Pedrali reserves the right to modify or upgrade the product without prior notice.
I colori sono indicativi. Pedrali si riserva la facoltà di apportare modifiche o migliorie senza alcun preavviso.

Category F

Genuine leather / Cuoio naturale



F05



F01

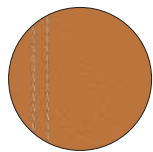

F04

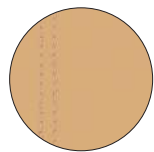

F03

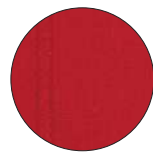

F06



F07

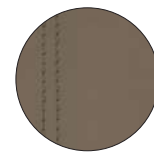

F08



F09

Regenerated leather / Cuoio rigenerato



F11



F12



F13



F17



F18

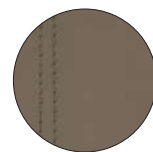

F19

Colours are indicative. Pedrali reserves the right to modify or upgrade the product without prior notice.
I colori sono indicativi. Pedrali si riserva la facoltà di apportare modifiche o migliorie senza alcun preavviso.

Category G

Fire retardant wool / Lana ignifuga

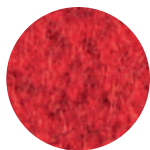

G21

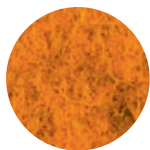

G22



G23



G24

- COLLECTION / COLLEZIONE

kvadrat - DIVINA MELANGE
DESIGNER Finn Skødt

- FLAME RESISTANCE / RESISTENZA AL FUOCO

AS/NZS 1530.3
ASTM E84 Class B Unadhered
ASTM E84 Class A Adhered
BS 5852 Part 1
BS 5867 part 2 type B
CAN ULC S109 with treatment
EN 1021-1/2
EN 13501, B-s2, d0 with treatment
IMO FTP Code 2010: Part 8
NF D60-013
NFPA 260
NFPA 701 with treatment
ÖNORM B1/ Q1
SN 198 898 5.3 with treatment
UNI 9175 Classe 1 IM
US CA TB 117-2013

Fire retardant wool / Lana ignifuga

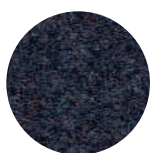

G110

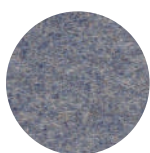

G111

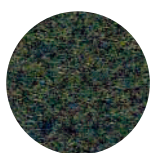

G112

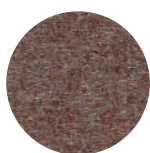

G113



G114



G115



G116

- COLLECTION / COLLEZIONE

kvadrat - DIVINA MD
DESIGNER Finn Skødt

- FLAME RESISTANCE / RESISTENZA AL FUOCO

AS/NZS 1530.3
ASTM E84 Class B Unadhered
ASTM E84 Class A Adhered
BS 5852 Crib 5 with treatment
BS 5852 Part 1
BS 5867 part 2 type B
CAN ULC S109 with treatment
EN 1021-1/2
EN 13501, B-s2, d0 with treatment
IMO FTP Code 2010: Part 8
NF D60-013
NFPA 260
NFPA 701 with treatment
ÖNORM B1/ Q1
SN 198 898 5.3 with treatment
UNI 9175 Classe 1 IM
US CA TB 117-2013

Colours are indicative. Pedrali reserves the right to modify or upgrade the product without prior notice.
I colori sono indicativi. Pedrali si riserva la facoltà di apportare modifiche o migliorie senza alcun preavviso.

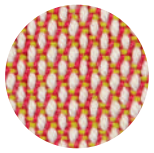

G59

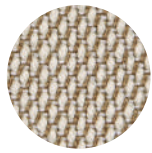

G66

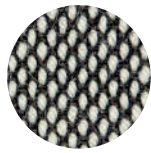

G63

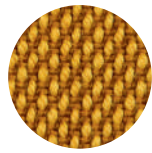

G67

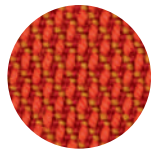

G69

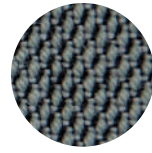

G62

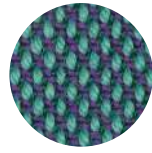

G68

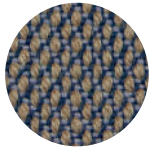

G64



G65

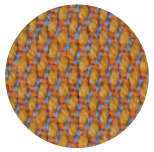

G190

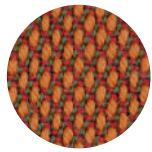

G191

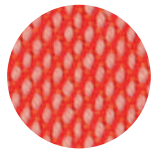

G192

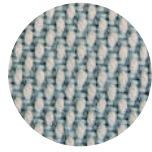

G193

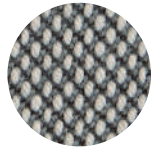

G194

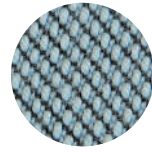

G195

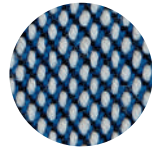

G196

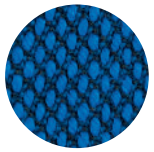

G197



G71

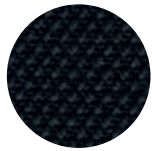

G70

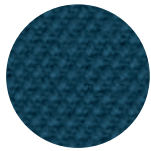

G75

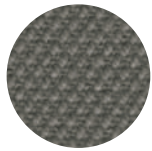

G73

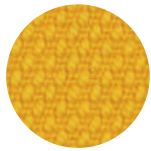

G78

• COLLECTION / COLLEZIONE

kvadrat

STEELCUT TRIO

G59+G69; G190+G197

STEELCUT

G70+G78

DESIGNER Dijkmeijer & Ridolfo

• FLAME RESISTANCE / RESISTENZA AL FUOCO

AS/NZS 1530.3

BS 5852 Part 1

BS 5852 Crib 5 with treatment

EN 1021 – 1/2

IMO FTP Code 2010: Part 8

NF D60-013

NFPA 260

SN 198 898 5.3 with treatment

UNI 9175 Classe 1 IM

US CA TB 117-2013

for G59+G69; G190+G197:

AS/NZS 3837 Class 2

BS 5852 IGNITION SOURCE 3

GB 50222 B1 with treatment

ÖNORM B1/Q1



Fire retardant fabric / Tessuto ignifugo

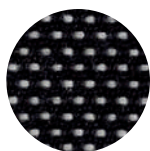

G100

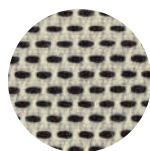

G101

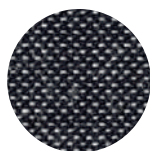

G102

- COLLECTION / COLLEZIONE

kvadrat - BASEL

DESIGNER Herzog & de Meuron

- FLAME RESISTANCE / RESISTENZA AL FUOCO

AS/NZS 3837 Class 2
 BS 5852 Part 1
 BS 5852 Crib 5 with treatment
 EN 1021 – 1/2
 GB 50222 B1 with treatment
 IMO FTP Code 2010: Part 8

NFPA 260
 NF D60-013
 ÖNORM B1/Q1
 SN 198 898 5.3 with treatment
 UNI 9175 Classe 1 IM
 US CA TB 117-2013



Fire retardant fabric / Tessuto ignifugo



G120

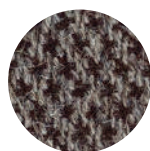

G121

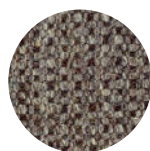

G122

- COLLECTION / COLLEZIONE

kvadrat - MOLLY

DESIGNER Åsa Pärson

- FLAME RESISTANCE / RESISTENZA AL FUOCO

BS 5852 Part 1
 BS 5852 Crib 5 with treatment
 EN 1021 – 1/2
 IMO FTP Code 2010: Part 8

NFPA 260
 NF D60-013
 ÖNORM B1/Q1
 UNI 9175 Classe 1 IM
 US CA TB 117-2013



Fire retardant fabric / Tessuto ignifugo

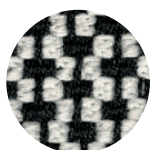

G130

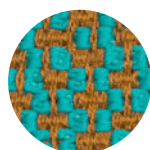

G131

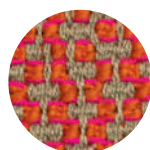

G132



G133

- FLAME RESISTANCE / RESISTENZA AL FUOCO

BS 5852:1979 (Part 1)
 BS 5852:2006 (Part 2) Crib 5
 DIN 4102-1 B2
 EN 1021 –1 and –2
 EN 13501-1
 FAR 25.853 (12 sec. vertical)
 IMO: 2014/90/EU (MED)
 UNI 9175 Classe 1 IM
 US CA TB 117-2013

Fire retardant fabric / Tessuto ignifugo

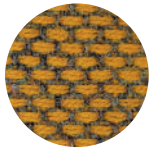

G140

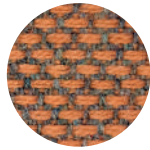

G141

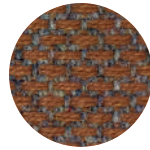

G142



G143



G144

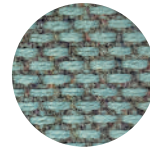

G145



G146

- COLLECTION / COLLEZIONE

kvadrat - RE-WOOL

DESIGNER Margrethe Odgaard

- FLAME RESISTANCE / RESISTENZA AL FUOCO

AS/NZS 1530.3

AS/NZS 3837 Class 2

BS 5852 Part 1

BS 5852 Crib 5 with treatment

BS 5852 IGNITION SOURCE 3

EN 1021 - 1/2

IMO FTP Code 2010: Part 8

NF D60-013

ÖNORM B1/Q1

UNI 9175 Classe 1IM

US CA TB 117-2013

Fire retardant fabric / Tessuto ignifugo

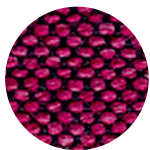

G150

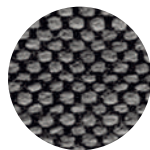

G151

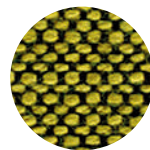

G152

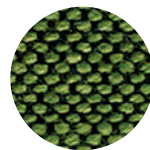

G153

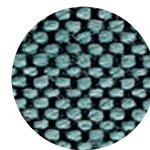

G154

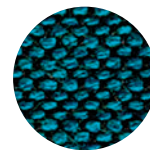

G155

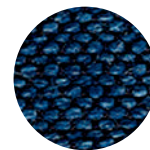

G156

- COLLECTION / COLLEZIONE

svensson - BALANCE

- FLAME RESISTANCE / RESISTENZA AL FUOCO

BS 5852 Crib 5

EN ISO 1021 Part 1&2

IMO FTP Code 2010: Part 8

UNI 9175 Classe 1 IM

US CA TB 117-2013

Fire retardant fabric / Tessuto ignifugo

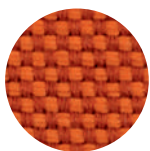

G170

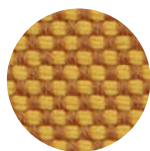

G171

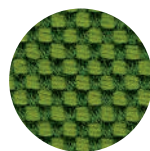

G172

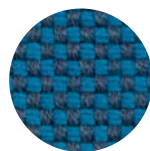

G173

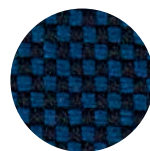

G174

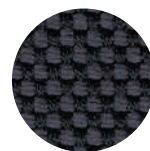

G175

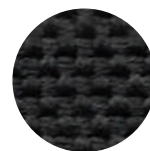

G176



G210



G211



G212

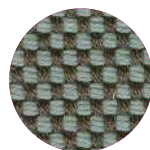

G213

- FLAME RESISTANCE / RESISTENZA AL FUOCO

BS 5852:1979 (Part 1)

BS 5852:2006 (Part 2) Crib 5

DIN 4102-1 B2

EN 13501-1

EN 1021 -1 and -2

FAR 25.853 (12 sec. vertical)

IMO: 2014/90/EU (MED)

UNI 9175 Classe 1 IM

US CA TB 117-2013

Colours are indicative. Pedrali reserves the right to modify or upgrade the product without prior notice.
I colori sono indicativi. Pedrali si riserva la facoltà di apportare modifiche o migliorie senza alcun preavviso.

Fire retardant fabric / Tessuto ignifugo



G200



G201



G202



G203

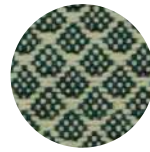

G204

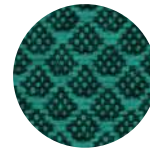

G205

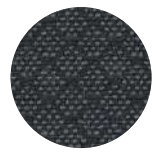

G206

- COLLECTION / COLLEZIONE
kvadrat - JAALI
DESIGNER Doshi Levien

- FLAME RESISTANCE / RESISTENZA AL FUOCO
AS/NZS 1530.3
BS 5852 Part 1
BS 5852 Crib 5 with treatment
BS 5852 IGNITION SOURCE 3
EN 1021-1/2

IMO FTP Code 2010: Part 8
NF D60-013
SN 198 898 5.3 with treatment
UNI 9175 Classe 1IM
US CA TB 117-2013

Fire retardant fabric / Tessuto ignifugo



G220

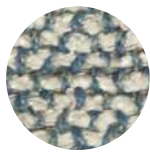

G221



G222



G223



G224



G225

- COLLECTION / COLLEZIONE
kvadrat - SAHCO
MOSS
DESIGNER Vincent Van Duysen

- FLAME RESISTANCE / RESISTENZA AL FUOCO
BS 5852 Part 1
BS 5852 Crib 5 with treatment
EN 1021-1/2
US CA TB 117-2013

Fire retardant fabric / Tessuto ignifugo



G07

- FLAME RESISTANCE / RESISTENZA AL FUOCO
BS EN 1021 1&2
BS EN 1021-1
ÖNORM A3800-B2-B3825-Q1 UK
NF P 92-503 M3
US CA TB 117-2013

Fire retardant fabric / Tessuto ignifugo



G160



G161



G162



G163



G164



G165



G166

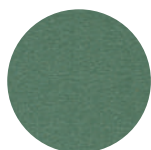

G167



G168



G169

- COLLECTION / COLLEZIONE
kvadrat - HERO
DESIGNER Patricia Urquiola

- FLAME RESISTANCE /
RESISTENZA AL FUOCO
AS/NZS 3837 Class 2
BS 5852 Crib 5 with treatment
BS 5852 Part 1
EN 1021 - 1/2
IMO FTP Code 2010: Part 7
with treatment
IMO FTP Code 2010: Part 8
NF D60-013
SN 198 898 5.3 with treatment
UNI 9175 Classe 1 IM
US CA TB 117-2013

Fire retardant velvet / Velluto ignifugo



G180



G181

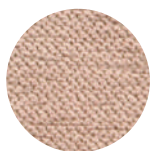

G182

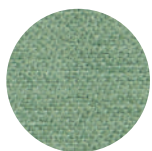

G183

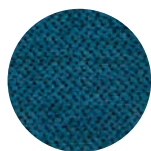

G184

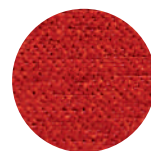

G185

- COLLECTION / COLLEZIONE
kvadrat - STILL
DESIGNER Georgina Wright

- FLAME RESISTANCE / RESISTENZA AL FUOCO
ASTM E84 Class A
BS 5852 Crib 5
BS 5852 Part 1
BS 5867 Part 2 type B
DIN 4102 B1
EN 1021-1/2
EN 13501-1, B-s1, d0
IMO FTP Code 2010:Part 8
NF D60-013
NF P92 507 M1
NFPA 701
ÖNORM B1/Q1
SN 198 898 5.2
UNI 9175 Classe 1 IM
UNI 9177 Classe 1
US CA TB 117-2013

Velvet / Velluto



G230



G231



G232



G233



G234

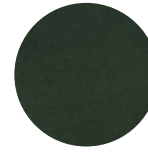

G235



G236



G237



G238



G239

- **FLAME RESISTANCE / RESISTENZA AL FUOCO**
BS 5852 Part 1
US CA TB 117-2013

Category H

Fire retardant simil leather / Finta pelle ignifuga



H82



H85



H87

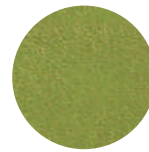

H89

- **FLAME RESISTANCE / RESISTENZA AL FUOCO**
BS 5852-1 cigarette test
BS 5852-1 match test
BS 5852 crib 5
EN 1021-1
EN 1021-2
IMO FTP CODE 2010
US CA TB 117:2013
UNI 9175 classe 1IM

Fire retardant simil leather / Finta pelle ignifuga



H30



H29



H28



H27



H24



H22

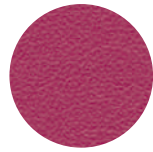

H23



H21

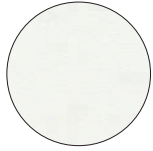

H20



H26



H31

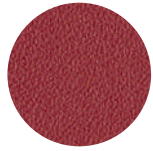

H32

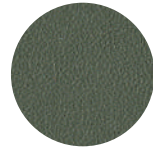

H33



H34



H35



H100



H101



H102



H103



H104

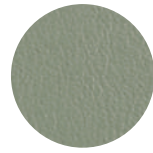

H105



H106



H107



H108

- **FLAME RESISTANCE / RESISTENZA AL FUOCO**
 BS 5852 Crib 5
 BS 5852 Part 1-2
 EN 1021 Part 1-2
 IMO resolution FTP Code 2010
 IMO resolution A.652 (16):1989
 UNI 9175 Classe 1 IM
 US CA TB 117-2013

Fire retardant fabric / Tessuto ignifugo



H60

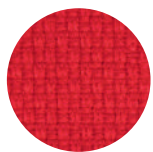

H61

- **FLAME RESISTANCE / RESISTENZA AL FUOCO**
 BS EN 1021 1&2
 BS EN 1021-1
 BS 5852 Part 1 0, 1
 UNI 9175 Classe 1 IM
 US CA TB 117-2013

Colours are indicative. Pedrali reserves the right to modify or upgrade the product without prior notice.
 I colori sono indicativi. Pedrali si riserva la facoltà di apportare modifiche o migliorie senza alcun preavviso.



Fire retardant fabric / Tessuto ignifugo

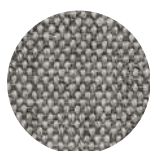

H120

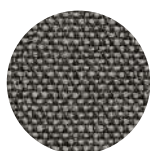

H121

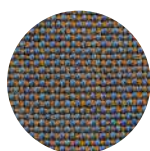

H122

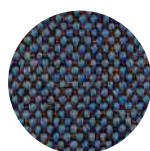

H123



H124



H125

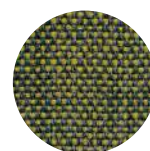

H126

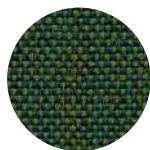

H127

• COLLECTION / COLLEZIONE
kvadrat - REMIX 3
DESIGNER Giulio Ridolfo

• FLAME RESISTANCE / RESISTENZA AL FUOCO
AS/NZS 1530.3
AS/NZS 3837, class 2
ASTM E84 Class A
BS 5852 Crib 5 with treatment
BS 5852 IGNITION SOURCE 3
BS 5852 Part 1
EN 1021 - 1/2
GB 50222 B1 with treatment

IMO FTP Code 2010:Part 7
with treatment
IMO FTP Code 2010: Part 8
NF D60-013
NFPA 260
ÖNORM B1/Q1
SN 198 898 5.3 with treatment
UNI 9175 Classe 1 IM
US CA TB 117-2013

Fabric / Tessuto



H140



H141



H142



H143

• FLAME RESISTANCE / RESISTENZA AL FUOCO
BS 5852 Crib 5 with treatment
EN ISO 1021 Part 1
US CA TB 117-2013



Fire retardant velvet / Velluto ignifugo



H41



H40



H44



H45



H46

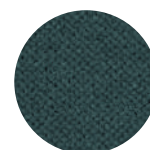

H51

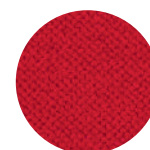

H53

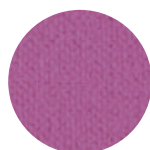

H52



H42

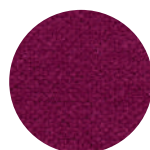

H47

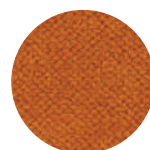

H48

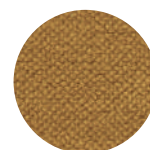

H43

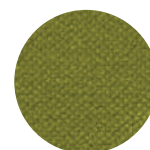

H49

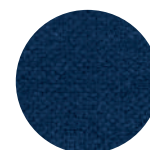

H50

• FLAME RESISTANCE / RESISTENZA AL FUOCO
BS 5852 Part 0,1
DIN 4102 B1
EN 1021-1&2
IMO MSC 307(88) Annex 1 Part 7-8

NF P 92-503-507 M1
NFPA 260:2019
UNI 9177 Classe 1
UNI 9175 Classe 1 IM
US CA TB 117-2013

Colours are indicative. Pedrali reserves the right to modify or upgrade the product without prior notice.
I colori sono indicativi. Pedrali si riserva la facoltà di apportare modifiche o migliorie senza alcun preavviso.

Category N

Fire retardant fabric / Tessuto ignifugo



N06



N07

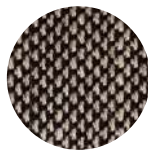

N05

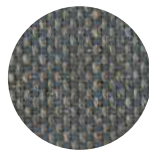

N08

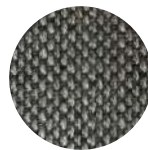

N01



N02

• COLLECTION / COLLEZIONE

kvadrat - SUNNIVA

DESIGNER Raf Simons & Fanny Aronsen

• FLAME RESISTANCE / RESISTENZA AL FUOCO

AS/NZS 3837, class 2
BS 5852 Part 1 with treatment
BS 5852 Crib 5 with treatment
EN 1021 – 1/2
NFPA 260
US CA TB 117-2013
IMO FTP Code 2020: Part 8 with treatment

Fire retardant velvet / Velluto ignifugo



N20



N21

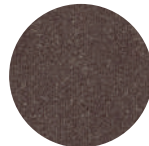

N22



N23

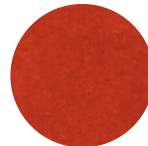

N24



N25



N26

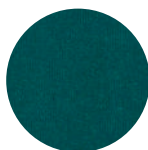

N27

• COLLECTION / COLLEZIONE

kvadrat - SAHCO

BALBOA

DESIGNER Najberg

• FLAME RESISTANCE / RESISTENZA AL FUOCO

BS 5852 Crib 5
BS 5867 Part 2 Type B
DIN 4102 B1
EN 1021-1/2
IMO FTP Code 2010: Part 8
NFPA 701
ÖNORM B1/Q1
SN 198 898 5.2
UNI 9175 1IM
US CA TB 117-2013

Fabric / Tessuto



N30



N31

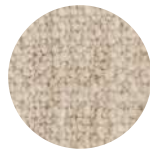

N32

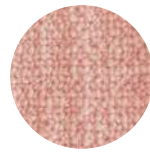

N33

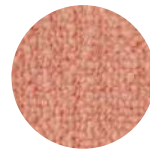

N34

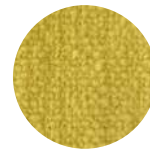

N35

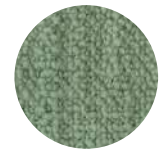

N36

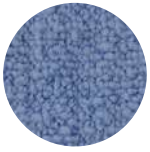

N37



N38

- **FLAME RESISTANCE / RESISTENZA AL FUOCO**
BS 5852-1 cigarette test
BS 5852-1 match test
BS 5852 Crib 5
US CA TB 117-2013

Category P

Mid grain leather / Pelle mezzo fiore



PBI

PLA

PSA

PGC

PGA

PGR

PBE



PTA

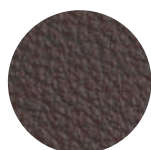

PMA



PNE



PRO



PTE



PGN

• COLLECTION / COLLEZIONE



• FLAME RESISTANCE /
RESISTENZA AL FUOCO
BS 5852:1979
BS EN 1021-1-2:2006
IMO RES A652 (16)
US CA TB 117-2013

Perforated mid grain leather / Pelle mezzo fiore traforata

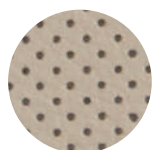

PGCF

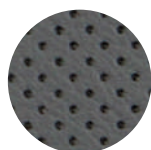

PGRF

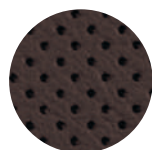

PMAF

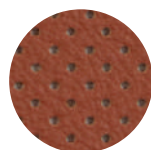

PTEF

• COLLECTION / COLLEZIONE



• FLAME RESISTANCE /
RESISTENZA AL FUOCO
BS 5852:1979
BS EN 1021-1-2:2006
IMO RES A652 (16)
US CA TB 117-2013

For Vic and Vic Metal
Per Vic e Vic Metal

Mid grain leather / Pelle mezzo fiore



PBS

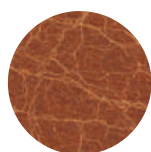

PCO

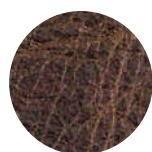

PMS

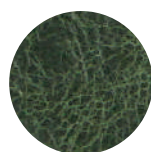

PVE

• COLLECTION / COLLEZIONE
gruppo mastrotto - TUSCANIA

• FLAME RESISTANCE /
RESISTENZA AL FUOCO
BS 5852:1979
BS EN 1021-1-2:2006
US CA TB 117-2013

For Malmö 296, 391, 396, 242 and 246
Per Malmö 296, 391, 396, 242 e 246

Colours are indicative. Pedrali reserves the right to modify or upgrade the product without prior notice.
I colori sono indicativi. Pedrali si riserva la facoltà di apportare modifiche o migliorie senza alcun preavviso.

PEDRALI PRICELIST | Edition February 2023

Copyright © 2023, Pedrali S.p.A. All rights reserved



The mark of responsible forestry

Look for FSC™ certified products
Cerca i prodotti certificati FSC™

Weights, measurements and colours are indicative. Pedrali reserves the right to modify or upgrade the products without prior notice.

Pesi, dimensioni e colori sono indicativi. Pedrali si riserva la facoltà di apportare modifiche o migliorie senza alcun preavviso.

Industrial property right | Diritto di proprietà industriale

Pedrali's Collections are worldwide protected by the industrial property right and patents.

Tutte le collezioni Pedrali sono protette nel mondo dal diritto di proprietà industriale e da brevetti registrati.

